

GE  
Sensing

# Druck ADTS 405

## Air Data Test Systems

### User Manual K114

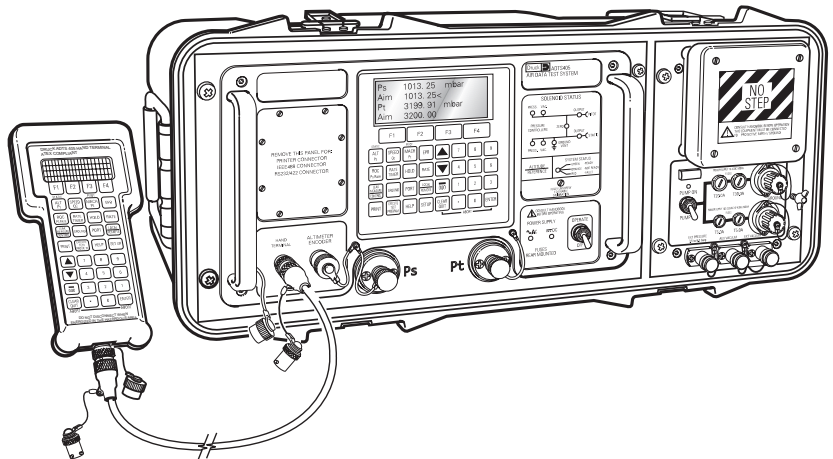
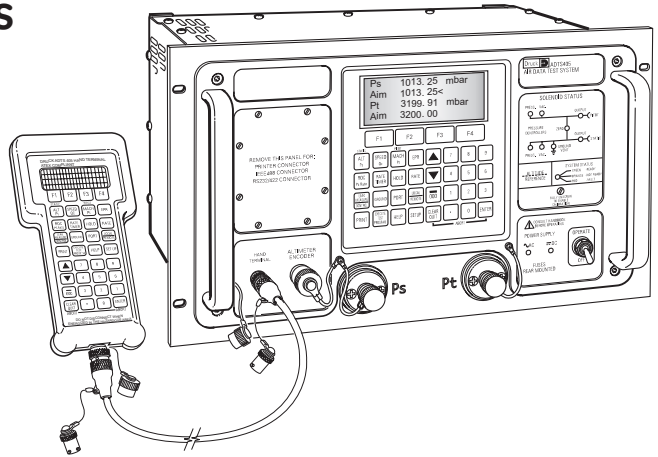



---

# Druck ADTS 405

## Air Data Test Systems

### User Manual

### K114

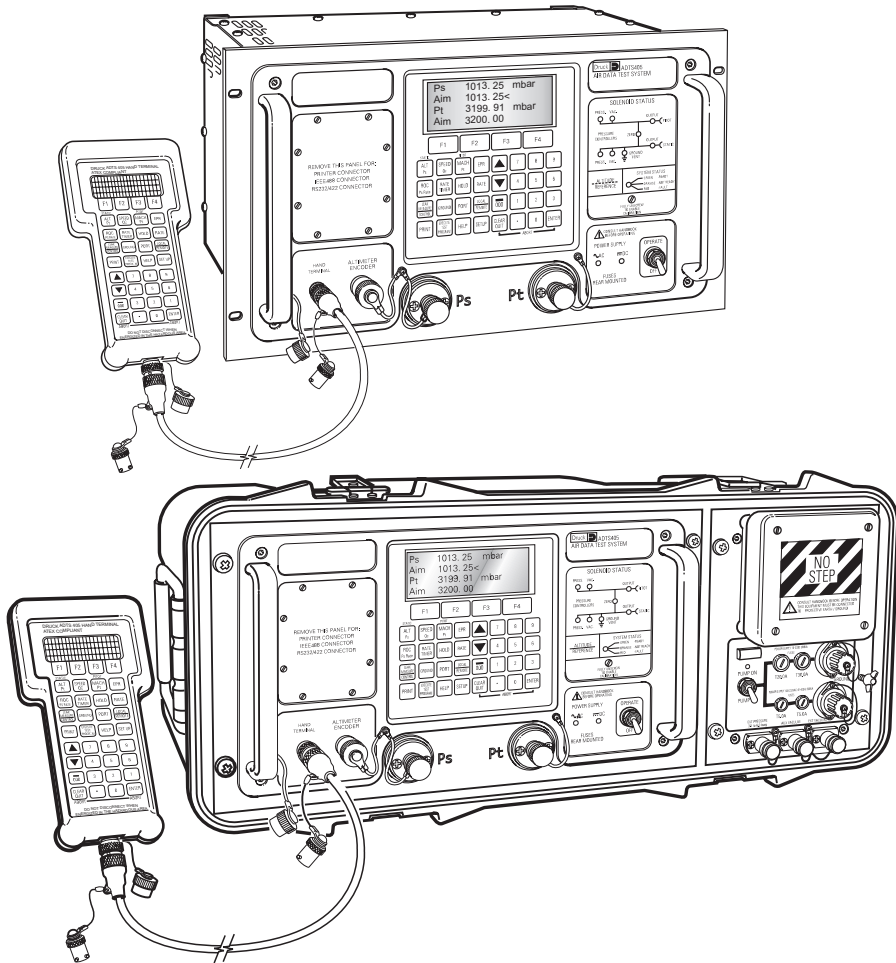



## Introduction

This technical manual provides operating instructions for the Air Data Test System compatible with the requirements of first line servicing.

## Scope

This technical manual contains a brief description, operation and testing procedures for the user of this equipment.

## Safety

- The manufacturer has designed this equipment to be safe when operated using the procedures detailed in this manual. Do not use this equipment for any other purpose than that stated.
- This publication contains operating and safety instructions that must be followed to make sure of safe operation and to maintain the equipment in a safe condition. The safety instructions are either warnings or cautions issued to protect the user and the equipment from injury or damage.
- Use qualified\* technicians and good engineering practice for all procedures in this publication.

## Pressure

- Do not apply pressure greater the maximum safe working pressure to the equipment.

## Toxic Materials

- There are no known toxic materials used in this equipment.

## Maintenance

- The equipment must be maintained using the manufacturer's procedures and should be carried out by authorised service agents or the manufacturer's service departments.

## Technical Advice

- For technical advice contact the manufacturer or subsidiary.

\* *A qualified technician must have the necessary technical knowledge, documentation, special test equipment and tools to carry out the required work on this equipment.*



This product meets the essential protection requirements of the relevant EEC directives. Further details of applied standards may be found in the product specification.

---

## Associated Publications

This lists the Druck manuals and publications referenced in this manual.

<b>Maintenance Manual</b>	<b>K244</b>
Air Data Test System ADTS 405	
<b>Calibration Manual</b>	<b>K199</b>
Air Data Test System ADTS 405	
<b>IEEE 488 OPT 2 Manual</b>	<b>K154</b>
Air Data Test System ADTS 405	
<b>SCPI IEEE 488 Manual</b>	<b>K157</b>
Air Data Test System ADTS 405	
<b>User Manual</b>	<b>K170</b>
Altimeter Encoder Option	
<b>User Manual</b>	<b>K185</b>
ARINC 429 Option	
<b>User Manual</b>	<b>K220</b>
Line Switching Unit LSU 100/101	
<b>User Manual</b>	<b>K222</b>
Line Switching Unit LSU 200	
<b>Operating and Communications Manual</b>	<b>K223</b>
Line Switching Unit LSU Series	
<b>TPM Programming and Communications Manual</b>	<b>K230</b>
Test Program Manager Version 4 for Windows	
<b>TPM User Manual</b>	<b>K250</b>
Test Program Manager Version 4 for Windows	

## Symbols



This symbol, on the instrument, indicates that the user should refer to the user manual.

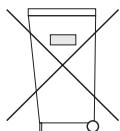

This symbol, on the instrument, indicates do not throw-away in domestic bin, hazardous material, dispose correctly in accordance with local regulations.



This symbol, on the instrument, indicates d.c.

---

## Table of Contents

Preliminary pages	
Introduction .....	i
Scope .....	i
Associated Publications .....	ii
Symbols .....	ii
Table of contents (this table) .....	iii
Abbreviations .....	viii
Glossary .....	ix
Returned Goods Procedure for Europe .....	xi
Returned Materials Procedure for USA .....	xii
Approved Service Agents .....	xii
ATEX Certified ADTS Hand Terminal .....	xiii
Pressure Units and Conversion Factors .....	xiv
Section	page
<b>1 DESCRIPTION</b>	
1.1 Introduction .....	1-1
1.2 Operating Range and Performance .....	1-3
1.3 Operating Limits .....	1-3
<b>2 INSTALLATION</b>	
2.1 Packaging .....	2-1
2.2 Packaging for Storage and Transportation .....	2-1
2.3 Electrical Connection .....	2-5
2.4 Pneumatic Pressure Connections .....	2-7
2.5 Positioning of the ADTS 405 .....	2-8
2.6 Positioning of the ADTS 405F .....	2-9
<b>3 OPERATION</b>	
3.1 Preparation .....	3-1
3.2 Display Functions and Units of Measure .....	3-2
3.3 Quick Reference .....	3-3
3.4 First Time Operators .....	3-4
3.5 Operation and Example Procedures .....	3-10
3.5.1 Checks Before Use .....	3-10
3.5.2 Operating Procedures .....	3-10
3.6 Power-up .....	3-10
3.7 Control or Measure Parameter .....	3-11
3.8 Leak Testing the ADTS 405 .....	3-12
3.9 Displays .....	3-15
3.10 Rate Timer Displays .....	3-17
3.11 Pt Only Display .....	3-18
3.12 Changing the Display .....	3-18
3.13 Changing the Units .....	3-19
3.14 Limit Checking .....	3-19
Aircraft System Protection .....	3-21
Mach Test and Constant Mach .....	3-21

---

Table of Contents (contd)

Section	page
True Airspeed .....	3-21
Airspeed Switch Test .....	3-22
Engine Pressure Ratio (EPR) .....	3-23
3.15 Testing Aircraft Systems or UUT .....	3-24
3.15.1 Go to Ground and Shut-Down .....	3-24
3.16 Options .....	3-25
SCPI IEEE 488 Option .....	3-25
Altimeter Encoder Option .....	3-25
ARINC 429 Option .....	3-25
3.17 SETUP and CONFIGuration .....	3-26
3.18 Quick Reference .....	3-26
<b>4 MAINTENANCE</b>	
4.1 Introduction .....	4-1
4.2 Materials .....	4-2
4.3 Maintenance Tasks .....	4-3
4.4 Routine Maintenance .....	4-4
<b>5 TESTING AND FAULT FINDING</b>	
5.1 Introduction .....	5-1
5.2 Standard Serviceability Test .....	5-2
5.3 Self-test Errors .....	5-4
5.4 Venting after Over-pressure .....	5-4
5.5 Fault Diagnosis .....	5-5
5.6 Further Testing .....	5-8
Test Environment and Preliminary Operations .....	5-8
Pressure Leak Check .....	5-8
Vacuum Leak Check .....	5-9
Controller Stability .....	5-10
5.7 Testing an Option Facility .....	5-11
Testing the IEEE 488 Facility .....	5-11
Configuring and Enabling the IEEE 488 Facility .....	5-11
Programming a Test of the IEEE 488 Facility .....	5-12
Connection of the IEEE 488 Facility .....	5-13
Testing the Altimeter Encoder Option .....	5-14
Configuring and Enabling the Altimeter Encoder Option .....	5-14
Optional cable (AAU-32) .....	5-15
Testing the ARINC 429 Option .....	5-16
Configuring and Enabling the ARINC 429 Option .....	5-16
5.8 Fault Finding .....	5-17
5.8.1 Error Messages .....	5-17
5.8.2 Warning Messages .....	5-18
<b>6 REFERENCE and SPECIFICATION</b>	
6.1 Introduction .....	6-1
6.2 Main Pressure Display .....	6-1
F1 - F4 .....	6-1
ALT Ps .....	6-2



## Table of Contents (contd)

Section		page
	SPEED Qc .....	6-2
	MACH Pt .....	6-3
	EPR .....	6-4
	ROC Ps RATE .....	6-4
	RATE TIMER .....	6-4
	HOLD .....	6-5
	RATE .....	6-6
	LEAK MEASURE/CONTROL .....	6-6
	GROUND .....	6-7
	PORT .....	6-9
	REMOTE .....	6-9
	PRINT .....	6-9
	EXECUTE TEST PROGRAM .....	6-10
	HELP .....	6-12
	▼ or ▲ (nudge keys) .....	6-12
	0 to 9 .....	6-12
	-000 .....	6-13
	CLEAR/QUIT .....	6-13
	ENTER .....	6-14
	CLEAR/QUIT + ENTER (ABORT) .....	6-14
6.3	SET-UP .....	6-15
	FULL SET-UP .....	6-15
	SETUP, [UNITS] .....	6-16
	SETUP, [LIMITS] .....	6-16
	SETUP, [OSC] .....	6-17
	SETUP, [MORE], [CONTROL],[Ps Pt DUAL] .....	6-17
	SETUP, [MORE], [DISPLAYS/OPTIONS],[DISPLAY TYPE] .....	6-18
	SET-UP, [MORE], [DISPLAYS/OPTIONS],[OPTIONS] .....	6-20
	SETUP, [MORE], [CLOSE OUTPUT VALVES] .....	6-20
	SETUP, [MORE], [OPEN OUTPUT VALVES] .....	6-20
	SET-UP, [MORE], [SYSTEM SELF TEST] .....	6-20
	SET-UP, ALT .....	6-21
	SET-UP, SPEED [AUTO ZERO] .....	6-21
	SET-UP, SPEED [CAS/TAS] .....	6-21
	SET-UP, SPEED [Pt TEMPERATURE] .....	6-23
	SET-UP, MACH .....	6-23
	SET-UP, RATE TIMER .....	6-23
	SET-UP, RATE .....	6-23
	SET-UP, LEAK MEASURE CONTROL, [AUTO LEAK] .....	6-24
	SET-UP, LEAK MEASURE CONTROL, [AUTO LIMIT] .....	6-24
	SET-UP, GROUND .....	6-24
	SET-UP, PORT .....	6-24
	SET-UP, PRINT,[DATE/TIME] .....	6-24
	SET-UP, EXECUTE TEST PROGRAM .....	6-24
	SET-UP, HELP .....	6-25
	SET-UP, ▼ or ▲ (nudge keys) .....	6-25

Table of Contents (contd)

Section	page
MINIMUM SET-UP .....	6-26
SETUP, [UNITS], [AERO] .....	6-26
SETUP, [UNITS], [PRESS] .....	6-26
SETUP, [LIMITS] .....	6-26
SETUP, ALT/Ps .....	6-27
SETUP, PORT .....	6-27
SETUP, HELP .....	6-27
6.4 CONFIGURATION .....	6-28
Procedure .....	6-28
Functions .....	6-28
CONFIG,[UNITS] .....	6-29
CONFIG, [LIMITS],[EDIT LIMITS],[EDIT EXISTING] .....	6-29
NAME .....	6-30
MIN ALT,MAX ALT, MIN CAS, MAX CAS .....	6-30
MAX MACH .....	6-30
MAX ROC, MAX RATE CAS .....	6-30
MIN Ps, MAX Ps, MIN Qc, MAX Qc .....	6-30
MAX RATE Ps, MAX RATE Qc .....	6-30
ARINC LIMITS .....	6-30
ALTITUDE CORRECTION .....	6-31
SAVING LIMITS .....	6-31
CONFIG, [LIMITS],[EDIT LIMITS],[MAX LIMITS] .....	6-32
CONFIG, [LIMITS],[EDIT LIMITS],[EDIT NEW] .....	6-32
CONFIG, [LIMITS],[CLEAR LIMITS] .....	6-32
CONFIG, [LIMITS],[LOCK AIRCRAFT] .....	6-32
CONFIG, [LIMITS],[DEFAULT AIRCRAFT] .....	6-32
CONFIG, [MORE],[CONTROL],[CONTROL MODE] .....	6-32
CONFIG, [MORE],[CONTROL],[CONTROL LOCK] .....	6-32
CONFIG, [MORE],[DISPLAY/OPTIONS],[DISPLAY TYPE] .....	6-32
CONFIG, [MORE],[DISPLAY/OPTIONS],[OPTIONS] .....	6-32
CONFIG, [MORE],[DATE/FORMAT] .....	6-32
CONFIG, [MORE],[SETUP MODE] .....	6-33
FULL .....	6-33
MINIMUM .....	6-33
OFF .....	6-33
CONFIG, SPEED,[AUTO ZERO] .....	6-33
CONFIG, SPEED,[CAS/TAS] .....	6-33
CONFIG, SPEED,[Pt TEMPERATURE] .....	6-33
CONFIG, RATE TIMER .....	6-33
CONFIG, RATE .....	6-33
CONFIG, LEAK MEASURE, [AUTO LEAK ON/OFF] .....	6-33
CONFIG, LEAK MEASURE, [AUTO LEAK LOCK] .....	6-33
CONFIG, LEAK MEASURE, [AUTO LIMIT ON/OFF] .....	6-33
CONFIG, LEAK MEASURE, [AUTO LIMIT LOCK] .....	6-33
CONFIG, GROUND .....	6-33

## Table of Contents (contd)

Section		page
	CONFIG, PORT .....	6-34
	CONFIG, REMOTE .....	6-34
	CONFIG, ETP,[AUTO RUN] .....	6-34
	CONFIG, ETP,[ERASE PROGRAMS] .....	6-34
	CONFIG, ETP,[RESULT] .....	6-34
	CONFIG, ▼ or ▲ (nudge keys) .....	6-34
	CONFIG, 000 .....	6-34
6.5	Specification .....	6-35
	Zone 2 Hazardous Area Definition .....	6-42

## List of Illustrations

Figure		page
Figure 1-1	ADTS 405 General View .....	1-2
Figure 1-2	ADTS 405F General View .....	1-2
Figure 2-1	Equipment and Parts .....	2-3
Figure 2-2	ADTS 405 Altitude Reference .....	2-8
Figure 2-3	ADTS 405F Altitude Reference .....	2-9
Figure 2-4	ADTS 405 General View .....	2-10
Figure 2-5	ADTS 405 Rear Panel View .....	2-11
Figure 2-6	ADTS 405F General View .....	2-12
Figure 3-1	Front Panel .....	3-2
Figure 3-2	Main Pressure Display (Leak Measure Mode) .....	3-12
Figure 3-3	Main Pressure Display (Control Mode) .....	3-13
Figure 3-4	Single Display .....	3-15
Figure 3-5	Dual Display .....	3-16
Figure 3-6	Triple Display .....	3-16
Figure 3-7	Rate Timer Display Aeronautical Units .....	3-17
Figure 3-8	Rate Timer Display Pressure Units .....	3-17
Figure 3-9	Pt Only Display .....	3-18
Figure 5-1	Fault Finding Chart .....	5-6
Figure 6-1	Altitude Correction Rack Mounting .....	6-22
Figure 6-2	Altitude Correction On-aircraft .....	6-22
Figure 6-3	ARINC 565 Operating Limits .....	6-31

## List of Tables

Table		page
2-1	Parts List .....	2-4
4-1	Maintenance Chart .....	4-1
4-2	Materials List .....	4-2
4-3	Tool and Test Equipment Requirements .....	4-2
5-1	Fault Finding .....	5-7
5-2	Error Messages .....	5-17
5-3	Warning Messages .....	5-18

## Abbreviations

The following abbreviations are used in this manual; the abbreviations are the same in the singular and plural.

A	Ampere
abs	Absolute
a.c.	Alternating current
ALT	Altitude
ATEX	Equipment for Use in Potentially Explosive Atmospheres
CAS	Calibrated airspeed
d.c.	Direct current
e.g.	For example
EOC	End of conversion
EPR	Engine pressure ratio
EPROM	Electrically programmable read only memory
etc.	And so on
Fig.	Figure
ft	Foot
g	Gauge
Hg	Mercury
Hz	Hertz
IAS	Indicated airspeed
i.e.	That is
IEEE 488	Institute of Electrical and Electronic Engineers standard 488 data
in	Inch
kg	Kilogram
LED	Light emitting diode
m	Metre
mA	Milliampere
max	Maximum
mbar	Millibar
min	Minute or minimum
mm	Millimetre
mV	Millivolts
No.	Number
N.m.	Newton metre
Para.	Paragraph
Ps	Static pressure
psi	Pounds per square inch
Pt	Total pressure
Qc	Differential pressure Ps-Pt
QFE	Local atmospheric pressure
QNH	Barometric pressure at sea level
ROC	Rate of climb
SCPI	Standard commands for programmable instruments
TAS	True airspeed
TE	Test equipment
V	Volts
Vc	Calibrated velocity
Vt	True velocity
+ve	Positive
-ve	Negative
°C	Degrees Celsius
°F	Degrees Fahrenheit

---

## Glossary

### Terminology

The terminology used in this manual is specific and individual interpretation must not be introduced. The terms are defined as follows:

Adjust	To bring to a more satisfactory state; to manipulate controls, levers, linkages, etc. to return equipment from an out-of-tolerance condition to an in-tolerance condition.
Align	To bring into line; to line up; to bring into precise adjustment, correct relative position or coincidence.
Assemble:	To fit and secure together the several parts of; to make or form by combining parts.
Calibrate:	To determine accuracy, deviation or variation by special measurement or by comparison with a standard.
Check:	Make a comparison of a measure of time, pressure, temperature, resistance, dimension or other quality with a known figure for that measurement.
Disconnect:	To detach the connection between; to separate keyed or matched equipment parts.
Dismantle:	To take apart to the level of the next smaller unit or down to all removable parts.
Examine:	To perform a critical visual observation or check for specific conditions; to test the condition of.
Fit:	Correctly attach one item to another.
Inspect:	Review the work carried out by Specialists to make sure it has been performed satisfactorily.
Install:	To perform operations necessary to properly fit an equipment unit into the next larger assembly or system.
Maintain:	To hold or keep in any particular state or condition especially in a state of efficiency or validity.
Make sure:	To confirm that a proper condition exists; to find out with certainty.
Operate:	Make sure that an item or system functions correctly as far as possible without the use of test equipment or reference to measurement.
Power-up:	To perform operations necessary to switch on a system ready for use.

- Power-down: To perform operations necessary to safely switch off a system after use.
- Readjust: To adjust again; to move back to a specified condition; to bring back to an in-tolerance condition.
- Reconnect: To rejoin or refasten that which has been separated.
- Refit: Fit an item which has previously been removed.
- Remove: To perform operations necessary to take an equipment unit out of the next larger assembly or system. To take off or eliminate. To take or move away.
- Repair: To restore damaged, worn out or malfunctioning equipment to a serviceable, usable or operable condition.
- Replace: Remove an item and fit a new or a serviced item.
- Reset: To put back into a required position, adjustment or condition.
- Service: To perform such operations as cleaning, lubricating and replenishing to prepare for use.
- Test: Ascertain by using the appropriate test equipment that a component or system functions correctly.

## Returned Goods Procedure for Europe

Should the unit become unserviceable and require repair it can be returned to the Druck Service Department.

Please contact our Service Department, either by 'phone, fax or e-mail to obtain a Returned Goods Authorization (RGA) number, providing the following information:

- Product (i.e. ADTS 405)
- Pressure medium (i.e. air, nitrogen)
- Serial number
- Details of defect/work to be undertaken
- Operating conditions

### **Safety Precautions**

You must also tell us if the product has been in contact with anything hazardous or toxic and the relevant COSH references and precautions to be taken when handling.

### **Important notice**

Service by unauthorized sources will affect the warranty and may not guarantee further performance.

---

## Returned Material Procedure for USA

Should the equipment become unserviceable it can be returned to the Druck Service Department.

Please contact our Service Department, either by phone, fax or e-mail to obtain a Returned Material Authorization (RMA) number, providing the following information:

- Product (i.e. ADTS 405)
- Pressure medium (i.e. air, nitrogen)
- Serial number
- Details of defect/work to be undertaken
- Operating conditions

### Safety Precautions

You must also tell us if the product has been in contact with anything hazardous or toxic and, the relevant MSDS references and precautions to be taken when handling.

### Important notice

Service by unauthorized sources will affect the warranty and may not guarantee further performance.

### Approved Service Agents

For the list of service centres visit our web site:

[www.gesensing.com](http://www.gesensing.com)



---

## ATEX Certified ADTS Hand Terminal

### CONDITIONS OF USE

The ATEX certified ADTS hand terminal supplied with the ADTS 405 can be used in zone 2 hazardous areas in accordance with the ATEX certification document and schedule.

### ATEX Certificate of Conformity

**No. Baseefa05ATEX0192**

BASEEFA being an Approved Certification Body, in accordance with Article 14 of the Council Directive of the European Communities of 18th December, 1975 (76/117/EEC) certifies that the apparatus has been found to comply with harmonised European Standards:

EN 60079-15: 2003

and has successfully met the examination and test requirements recorded in confidential report number:

**05(C)0154 (Baseefa) dated 12th October 2005**

**NOTE:** Refer to pages 2/2 of the Certificate of conformity for electrical connection parameters.

Rated Voltage = 32Vdc.

Marking detail:

**ADTS Hand Terminal**

**Baseefa05ATEX0192**

 II 3G IP54

**Baseefa05ATEX0192 (EC type examination certificate number)**

**EEx nA nL IIC T4 (-25°C < T<sub>amb</sub> <= 55°C)**

**Druck, LE6 0FH, UK**



— — — — —  
6 - 32V

Power  
3W Max



### SPECIAL CONDITION OF USE

- The power supplies must be isolated when connecting the ADTS hand terminal in the hazardous area.
- The ADTS hand terminal must not be disconnected when energized in the hazardous area.
- The ADTS hand terminal is a non-serviceable component. If the ADTS hand terminal becomes unserviceable it can only be replaced by another ATEX compliant hand terminal.

---

**Pressure units and conversion factors**

Pressure unit	Factor (Pascals)	Pressure unit	Factor (Pascals)
bar	100000	lbf/ft <sup>2</sup>	47.8803
lbf/in <sup>2</sup> (psi)	6894.76	inHg	3386.39
mH <sub>2</sub> O	9806.65	inH <sub>2</sub> O [1]	249.089
mbar	100	ftH <sub>2</sub> O [1]	2989.07
kgf/cm <sup>2</sup>	98066.5	atm	101325.0
kgf/m <sup>2</sup>	9.80665	pdl/ft <sup>2</sup>	1.48816
mmHg	133.322	dyn/cm <sup>2</sup>	0.1
cmHg	1333.22	hbar	1000000
mHg	133322.0	tonf/ft <sup>2</sup> (UK)	107252.0
mm/H <sub>2</sub> O [1]	9.80665	tonf/in <sup>2</sup> (UK)	15444300
cm/H <sub>2</sub> O [1]	98.0665	inH <sub>2</sub> O (USA) [2]	248.64135
N/m <sup>2</sup>	1	ftH <sub>2</sub> O (USA) [2]	2983.6983
hPa	100	kp/mm <sup>2</sup>	9806650
kPa	1000	kp/cm <sup>2</sup>	98066.5
MPa	1000000	kp/m <sup>2</sup>	9.80665
torr	133.322		

**Table of pressure units and conversion factors**

Unit Conversion

To convert FROM pressure VALUE 1 in pressure UNITS 1

TO pressure VALUE 2 in pressure UNITS 2, calculate as follows:

$$\text{VALUE 2} = \frac{\text{VALUE 1} \times \text{FACTOR 1}}{\text{FACTOR 2}}$$

**Note**

*The conversion factor for pressure units referenced [1] are calculated for a water temperature of 4°C. Pressure units referenced [2] are calculated for a water temperature of 68°F these units are normally used in the USA.*

## 1 DESCRIPTION

### 1.1 Introduction

- There are two versions of the ADTS 405, a 19", 6U high (10½") rack-mounted unit and a flight line unit.
- The ADTS 405 is a rack-mounted system and, with external pressure and vacuum supplies connected, provides measurement and control for leak checks, calibration accuracy checks and functional tests of air data instruments, components and systems.
- The ADTS 405F is a self-contained flight-line air data test system providing complete pressure and vacuum measuring and control for on-aircraft sense and leak testing, calibration accuracy checks and functional tests of air data instruments, components and systems. The unit comprises an electronics rack and pump rack enclosed in a high density, polyethylene case.
- The ADTS 405 displays and operates in either units of pressure measurement or aeronautical units. In the control mode, the rate that the pressures change towards new set-points can be controlled in true aeronautical rate units.
- There are two independent pneumatic channels connect to the aircraft or instrument systems, one for static and one for pitot. They can be operated as measure only channels with leak testing facility or each can be control channels producing true pressure conditions for altitude and airspeed.
- To protect sensitive instruments and equipment a 'ground' facility automatically and safely controls both channels to atmospheric pressure at the previously entered rates of change and then informs the operator when both channels are safely at 'ground'.
- The operator interface is either an ATEX certified hand terminal connected to the front panel or the key pad and display on the front panel. Both provide information and control selections for the user through the keys and display. The unit can also be controlled remotely using the IEEE 488 communications interface. The front panel contains the operate switch and a mimic panel with LED indicators showing the operation of the solenoid-operated pneumatic valves.
- The pump rack, on the ADTS 405F, produces pressure and vacuum supplies for the electronics rack and for external services. Located on the front panel, the external connectors provide for external pressure and vacuum supplies (EXT PRESSURE and EXT VACUUM) and an auxiliary static (vacuum) output (AUX). The rack is cooled by a fan located under a protective cover on the front panel. The power supply connection for the ADTS 405F is located on the front panel.

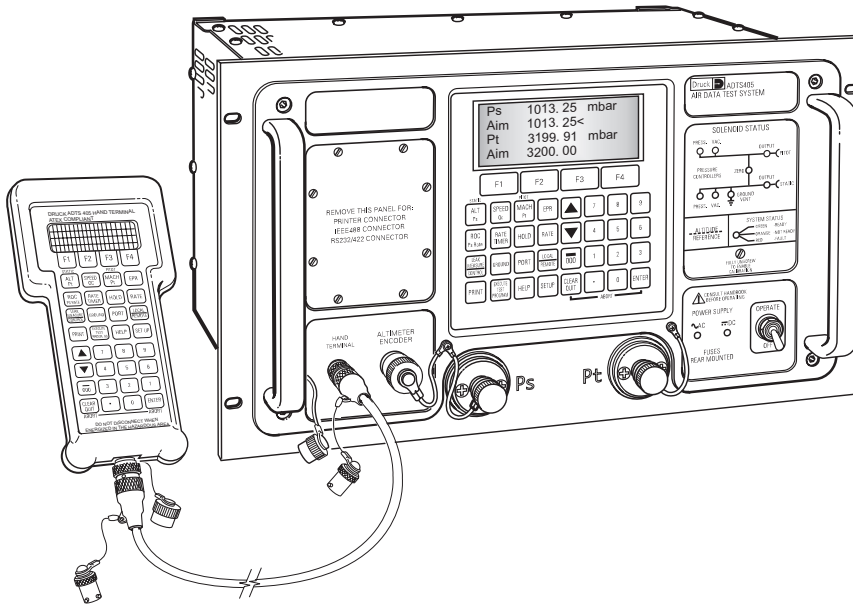

FIGURE 1-1 ADTS 405 GENERAL VIEW

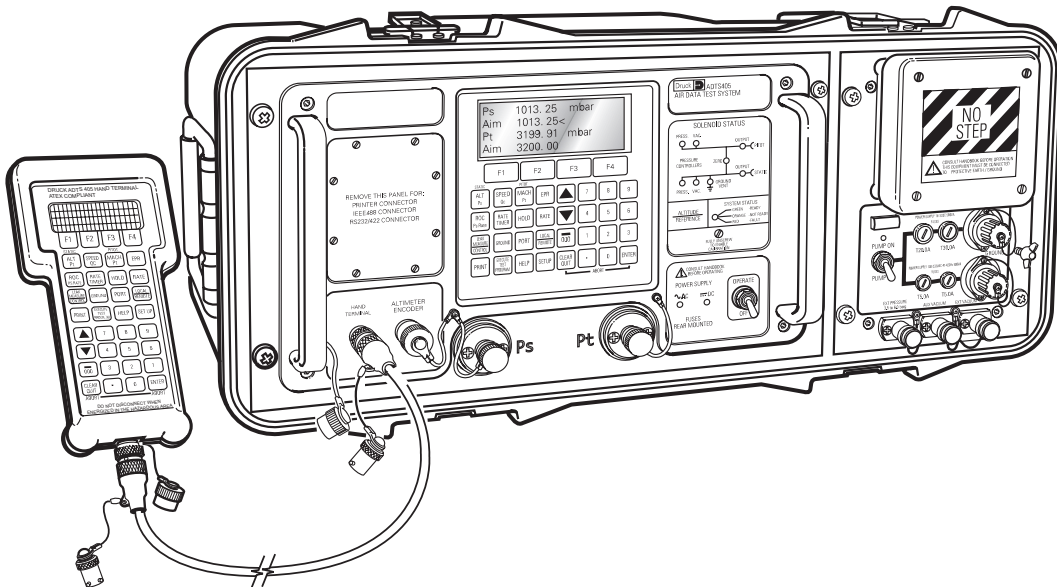

FIGURE 1-2 ADTS 405F GENERAL VIEW

## 1.2 Operating Range and Performance

- The ADTS 405 is supplied in one of two full-scale ranges (850 knots or 1000 knots) for measurement and control of the pitot pressure channel.
- Operating limits are set, pre-defined tabular limits known as STANDARD, CIVIL and MAX these can be selected through the SETUP menu (see Reference section 6). Operators may also configure the display to aeronautical or pressure units but should be aware that when units of pressure are selected, wider full-scale pressure limits will be enabled for some parameters.

## 1.3 Operating Limits

The following sets of operating limits are supplied with the ADTS 405.

### 850 knot range operating limits

Parameter	Max Limits	Standard limits	Civil limits
Min Alt	-3,000 ft	-2,000 ft	-1,000 ft
Max Alt	105,000 ft	80,000 ft	50,000 ft
Min CAS	-100 kts	0.0 kts	0 kts
Max CAS	850 kts	850 kts	450 kts
Min Ps	3.0 mbar	27.615 mbar	115.972 mbar
Max Ps	1355.00 mbar	1088.657 mbar	1050.406 mbar
Min Qc	-1,352.00 mbar	0.0 mbar	0 mbar
Max Qc	1,700.00 mbar	1688.00 mbar	368.01 mbar
Max Mach	12.35	2.5	1
Max ROC	100,000 ft/min	9,000 ft/min	6,000 ft/min
Max Rate CAS	2,000 kts/min	600 kts/min	600 kts/min
Max Rate Ps	10,000.00 mbar/min	200.00 mbar/min	100.00 mbar/min
Max Rate Qc	10,000.00 mbar/min	200.00 mbar/min	100.00 mbar/min
ARINC Limits	OFF	OFF	OFF
Alt Correction	0 ft	0 ft	0 ft

## 1000 knot range operating limits

Parameter	Max Limits	Standard limits	Civil limits
Min Alt	-3,000 ft	-3,000 ft	-1,000 ft
Max Alt	105,000 ft	80,000 ft	50,000 ft
Min CAS	-100 kts	0 kts	0 kts
Max CAS	1,000 kts	1,000 kts	450 kts
Min Ps	3.0 mbar	27.615 mbar	115.972 mbar
Max Ps	1355.00 mbar	1,128.029 mbar	1050.406 mbar
Min Qc	-1,352.00 mbar	-16.303 mbar	0 mbar
Max Qc	2,500.00 mbar	2,490.50 mbar	368.01 mbar
Max Mach	14.97	5	1
Max ROC	100,000 ft/min	15,000 ft/min	6,000 ft/min
Max Rate CAS	2,000 kts/min	700 kts/min	600 kts/min
Max Rate Ps	10,000.00 mbar/min	200.00 mbar/min	100.00 mbar/min
Max Rate Qc	10,000.00 mbar/min	200.00 mbar/min	100.00 mbar/min
ARINC Limits	OFF	OFF	OFF
ALT Correction	0 ft	0 ft	0 ft

## 2 INSTALLATION

### 2.1 Packaging

- On receipt of the ADTS 405 check the contents of the packaging against the following lists:

#### Packaging List - ADTS 405F

- i) Flight line ADTS 405F
- ii) Accessory bag
- iii) Power supply cable
- iv) Hand terminal
- v) Hand terminal cable - 2 m
- vi) Hand terminal cable - 18 m
- vii) Output, hose, 2.5m, red, AN6 - open
- viii) Output, hose, 2.5m, blue, AN4 - open
- ix) User Manual (this publication)
- x) Spare fuses (2 off)

#### Packaging List - ADTS 405

- i) Rack ADTS 405
- ii) Power supply cable
- iii) User Manual (this publication)
- iv) Output, hose, 2.5m, red, AN6 - open
- v) Output, hose, 2.5m, blue, AN4 - open
- vi) Input, hose, 2.5m, green, AN6 - open
- vii) Input, hose, 2.5m, yellow, AN4 - open
- viii) Spare fuses (2 off)
- ix) Plug, expansion port

### 2.2 Packaging for Storage or Transportation

- To store the unit or to return the unit for calibration or repair carry out the following procedures:
  - Pack the unit as detailed in the following procedure.
  - To return the unit for calibration or repair complete the return goods procedure as detailed in the preliminary pages.

### Procedure

- The unit should be at zero/ambient pressure. Disconnect the hose assemblies and stow in the shoulder bag.
  - ▢ Switch OFF and disconnect from the electrical power supply. Disconnect the power supply cable and the hand terminal cable. Disconnect the hand terminal cable from the hand terminal.
  - ▢ Stow the power supply cable, hand terminal cable and the hand terminal in the ADTS 405F lid. For ADTS 405 rack units these items should be placed in a sealed polythene bag.
  - ▢ Fit the lid to the unit.
- If available, use the original packing material. When using packing materials other than the original, proceed as follows.
  - ▢ Wrap unit in polyethylene sheeting.
  - ▢ Select a double-wall cardboard container. Inside dimensions must be at least 15 cm greater than the equipment. The carton must meet test strength requirements of >125 kg.
  - ▢ Protect all sides with shock-absorbing material to prevent equipment movement within the container.
- Seal carton with approved sealing tape.
- Mark carton "FRAGILE" on all sides, top, and bottom of shipping container.

### Environment

- The following conditions apply for both shipping and storage:
  - ▢ Temperature Range -40° to +70°C (-40° to +158°F)
  - ▢ Altitude ..... Up to 15,000 feet (4,570 metres)



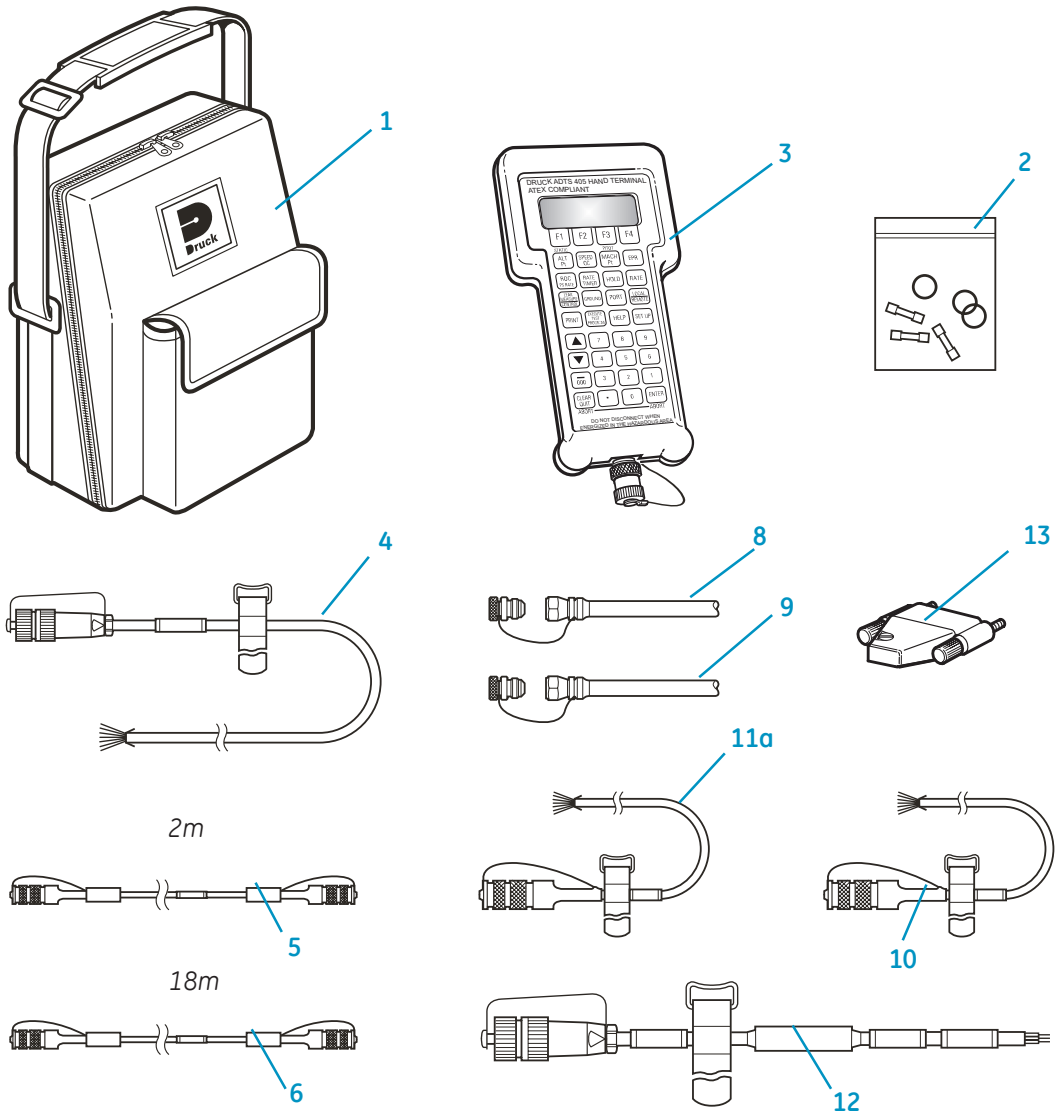

FIGURE 2.1 EQUIPMENT AND PARTS

No	Part Number	Description	Used On	Qty per assy
1	ADTS405-1728-39-M0	Bag, Shoulder	ADTS 405F	1
2	ADTS405-1728-36-M0	Kit, Fuse/ O-Ring	ADTS 405F and ADTS 405	1
3	ADTS405-1728-37-M1	Hand terminal, ATEX certified	ADTS 405F and ADTS 405	1
4	ADTS405-1728-47-M0	Cable, AC Power, 5M (260V Open End)	ADTS 405F and ADTS 405	1
5	ADTS405-1728-28-M0	Cable, Hand terminal 2M	ADTS 405F and ADTS 405	1
6a	ADTS405-1728-27-M0	Cable, Hand terminal 18M	ADTS 405F and ADTS 405	1
6b*	ADTS405-1728-29-M0	Cable, Hand terminal 30M (Option)	ADTS 405F and ADTS 405	1
7*	ADTS405-1729-52-M0	Kit, hose adaptor (2 x 2.5M AN ST/Open)	ADTS 405F and ADTS 405	1
8	ADTS405-1729-61-M0	Hose, Static (Ps), red, ST/OPN, AN6 (Special options available)	ADTS 405F and ADTS 405	1
9	ADTS405-1729-62-M0	Hose, Ptot (Pt), blue, ST/OPN, AN4 (Special options available)	ADTS 405F and ADTS 405	1
10	ADTS405-1728-34-M0	Cable, ARINC (Circular Connector) (Open End) (Option)	ADTS 405F and ADTS 405	1
11a	ADTS405-1728-35-M0	Cable, Altimeter Encoder, 6M (Open End) (Option)	ADTS 405F and ADTS 405	1
11b*	ADTS405-1891-61-M0	Altimeter Encoder Cable, 6M (AAU-32 altimeters) (Option)	ADTS 405F and ADTS 405	1
12	ADTS405-1728-48-M0	Cable, DC Power, 5M (Option)	ADTS 405F	1
13	ADTS405-1891-22-M0	Plug, expansion port	ADTS 405	1

TABLE 2-1 PARTS LIST

## 2.3 Electrical Connection

- WARNINGS:**
- 1 VOLTAGES IN EXCESS OF 30 VOLTS (RMS) AC OR 50VOLTS DC, IN CERTAIN CIRCUMSTANCES, CAN BE LETHAL. CARE MUST BE TAKEN WHEN WORKING ON LIVE, EXPOSED CONDUCTORS.
  - 2 DO NOT DISCONNECT THE HAND TERMINAL WHEN ENERGIZED IN THE HAZARDOUS AREA.

### Power Supply Connection

The unit must be connected to the correct electrical power supply as stated, adjacent to the power connector.

**CAUTIONS:**

- 1 THE SUPPLY MUST PROVIDE CONNECTION TO A PROTECTIVE GROUND TERMINAL. THE UNIT MUST, AT ALL TIMES, BE CONNECTED TO THE SUPPLY EARTH (GROUND).
- 2 THE POWER SUPPLY CABLE AND CONNECTOR MUST BE CORRECTLY RATED FOR THE POWER SUPPLY.

**Note:** The ADTS 405 is normally supplied with an approved power supply cable for use in the country of delivery. This can limit the maximum supply voltage that can be safely used.  
 e.g. a NEMA 5-15P terminated cable, for use in the U.S.A., is approved for a maximum of 125 V ac; it must be replaced for a higher supply voltage.

Pin	European Colour	U.S. Color	Function
1	Brown	Black	Live
4	Blue	White	Neutral
Centre	Green/Yellow	Green	Protective Earth (Ground)

### ADTS 405 rack mounted units

- o Make sure that the power supply is off before connecting the power cable .
- o If required, connect the hand terminal to the connector using either the 2 metre or 18 metre cable.

**Note:** Connecting the hand terminal disables the front panel key-pad.

- o Fit the expansion port plug (item 13, Table 2-1) to the rear panel expansion port.

**Note:** For units used with the Druck PV 103 Pump Unit connect the expansion cable, supplied with the PV 103, to the expansion port.

### Flight line units

- Make sure that the power supply is off before connecting the power cable and hand terminal cable.

**Note:** *The flight line version power cable supplies both the electronics and pump racks.*

- If required, connect the hand terminal to the connector on the front panel using either the 2 metre or 18 metre cable.

**Note:** *Connecting the hand terminal disables the front panel key-pad.*

- The two fuses, located in the holders and mounted on the front panel, protect the Electronics Rack and the Pump Rack. The fuses are connected in the live supply circuit and are rated at:

5A anti-surge HBC 250V

- An external earth (ground) cable may be connected to the stud on the front panel of the pump rack to ensure integrity of the earth (ground) connection.

### DC Power Option

The DC power option (nominal 28 V DC), can be an alternative power supply using an additional connector. This is located on the rear of the rack (ADTS 405) or on the pump front panel (ADTS 405F) both have the same connector details.

Pin	European Colour	U.S. Color	Function
1	Grey	Gray	+28V
2	White	White	0V Return
	Protective Earth (Ground)	Protective Ground	Protective Earth (Ground)

**Note:** *The unit will not be damaged if AC power and DC power are connected at the same time.*

2.4 Pneumatic Pressure Connections

ADTS 405 rack-mounted unit

Static (Ps) .....	AN-6 37° flare
Pitot (Pt) .....	AN-4 37° flare
Pressure supply .....	AN-4 37° flare
Vacuum supply .....	AN-6 37° flare

- Connect pressure and vacuum supplies to the rear panel PRESSURE and VACUUM connectors. The pressure supply should be clean, dry gas, nitrogen or air refer to the specification.
- Connect the Unit Under Test (UUT) to either the front panel or optional rear panel Ps (static) and Pt (pitot) output connectors.

**Note:** *Blanking caps must be fitted on unused front or rear outputs.*

ADTS 405F flight line

Static (Ps) .....	AN-6 37° flare
Pitot (Pt) .....	AN-4 37° flare
Pressure supply .....	AN-4 37° flare
Vacuum supply .....	AN-6 37° flare
Auxiliary vacuum supply .....	AN-4 37° flare

- In normal operation make sure that the correct blanking caps are fitted to the external connectors.
- The external pressure and vacuum connections are used when an external pump unit supplies the pressure and vacuum. This may increase the maximum achievable rates of change when connected to large volume systems.
- The auxiliary vacuum, AUX VACUUM, can be used to supply the suction-type static adaptors and provides a nominal 100 mbar (3 inHg) absolute vacuum. When not in use, a blanking cap must be fitted.

**Note:** *A leak of this blanking cap affects the performance of the ADTS 405F.*

### Single channel operation

- For single pipe testing of airspeed indicators or similar, requiring only Pt (pitot), connect the UUT to Pt (pitot). The Ps (static) output must be left open to atmosphere (no blanking cap) to provide a reference pressure.

**Note:** The Pt ONLY mode of operation must be used in this configuration.

- For single pipe testing of altimeters or similar, requiring only Ps (static), connect the UUT to Ps (static). The Pt (pitot) output should be left with a blanking cap fitted.

**Note:** The Ps ONLY mode of operation must be used in this configuration.

## 2.5 Positioning of the ADTS 405

- It is important that the position of the ADTS 405 in relation to the components under test is known. An altitude correction must be made to allow for the difference in height between the reference level, indicated on the mimic panel, and the components under test. The Reference section contains details of altitude correction (SETUP, ALTITUDE).

**WARNING:** OBSERVE THE APPROPRIATE SAFETY INSTRUCTIONS AND PROCEDURES DETAILED IN THE COMPONENT MAINTENANCE MANUALS.

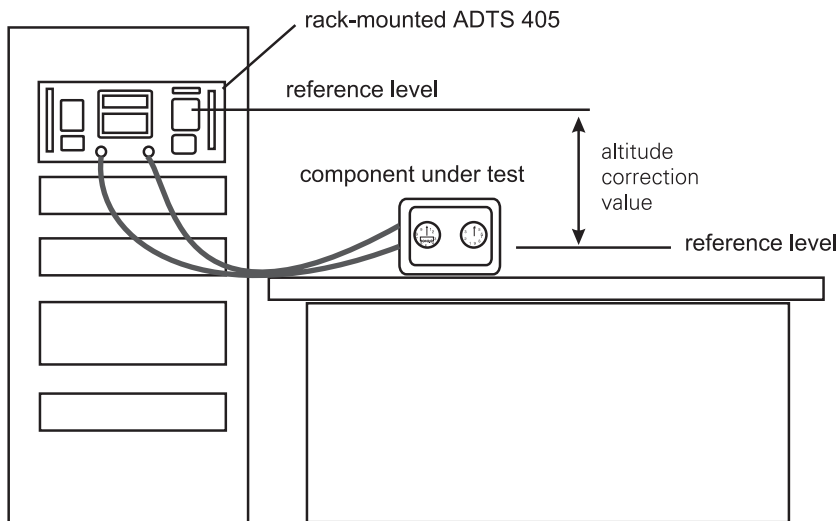

Corrected altitude = Altitude measurement + Altitude correction value

FIGURE 2-2 ADTS 405 ALTITUDE REFERENCE

## 2.6 Positioning of the ADTS 405F

**WARNING: DO NOT DISCONNECT THE ATEX CERTIFIED HAND TERMINAL WHEN ENERGIZED IN THE HAZARDOUS AREA. THIS CAN CAUSE AN EXPLOSION.**

- To operate safely, the ADTS 405F must be placed outside the user defined zone 2 hazardous area. Only the ATEX certified hand terminal may be used inside the defined zone 2 hazardous area (refer to section 6.5 for a definition).
- It is important that the position of the ADTS 405F in relation to the aircraft altitude sensors is known. An altitude correction must be made to allow for the difference in height between the reference level and the aircraft's altitude sensors. The Reference section contains details of altitude correction.

**WARNING: OBSERVE THE APPROPRIATE SAFETY INSTRUCTIONS AND PROCEDURES DETAILED IN THE AIRCRAFT MAINTENANCE MANUALS.**

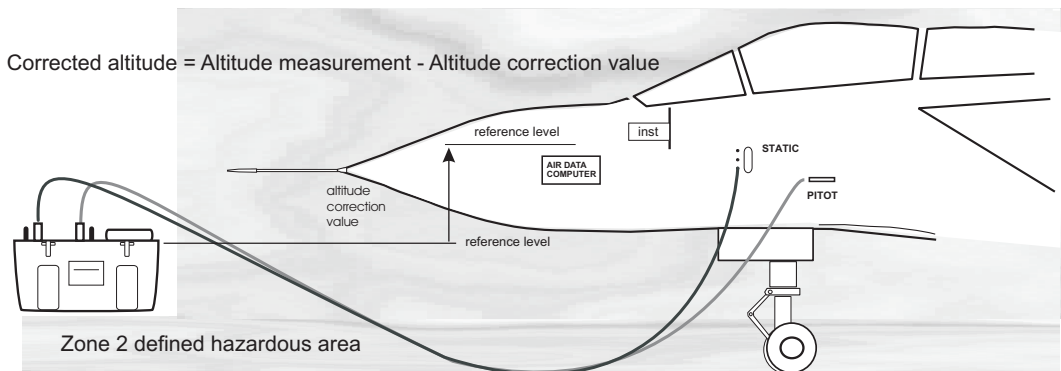

FIGURE 2-3 ADTS 405F ALTITUDE REFERENCE

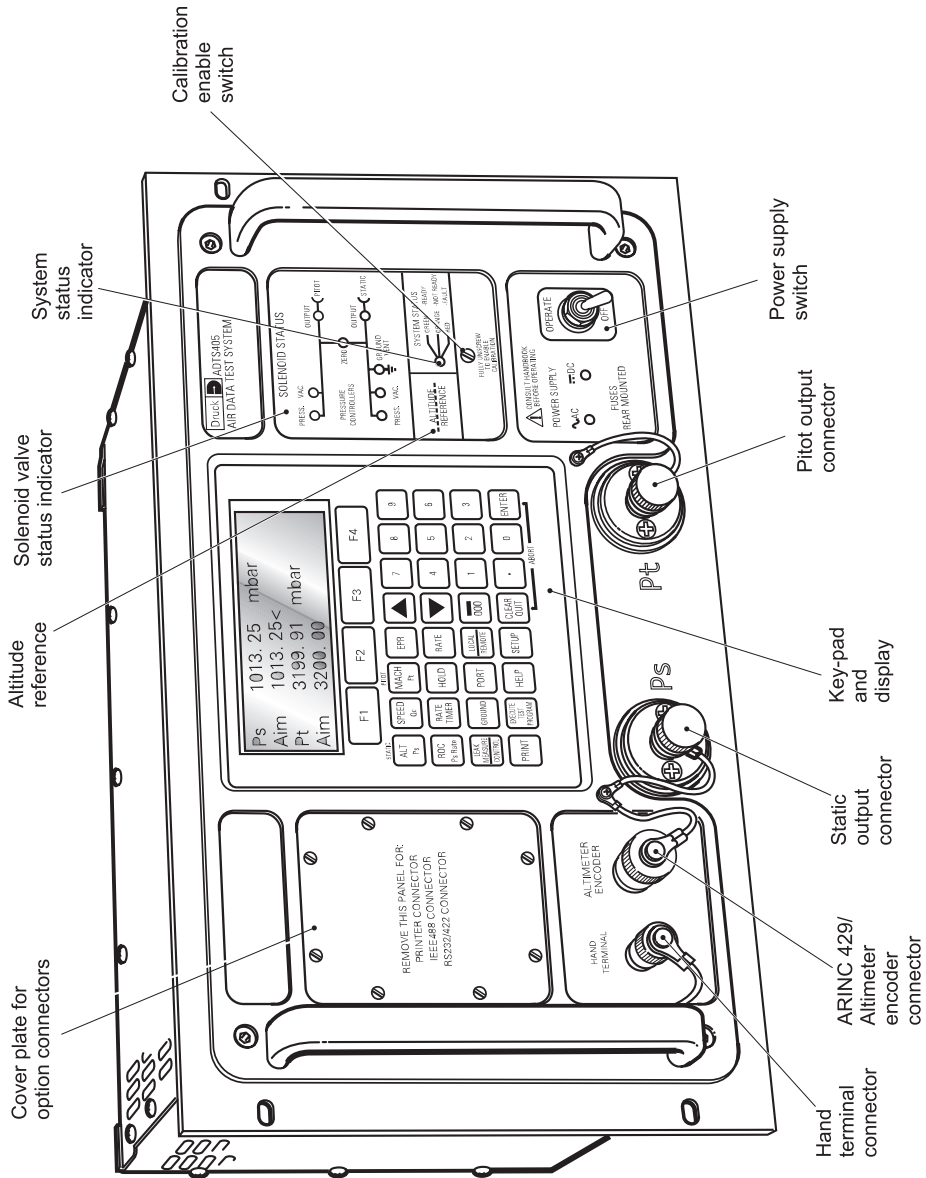

FIGURE 2-4 ADTS 405 GENERAL VIEW



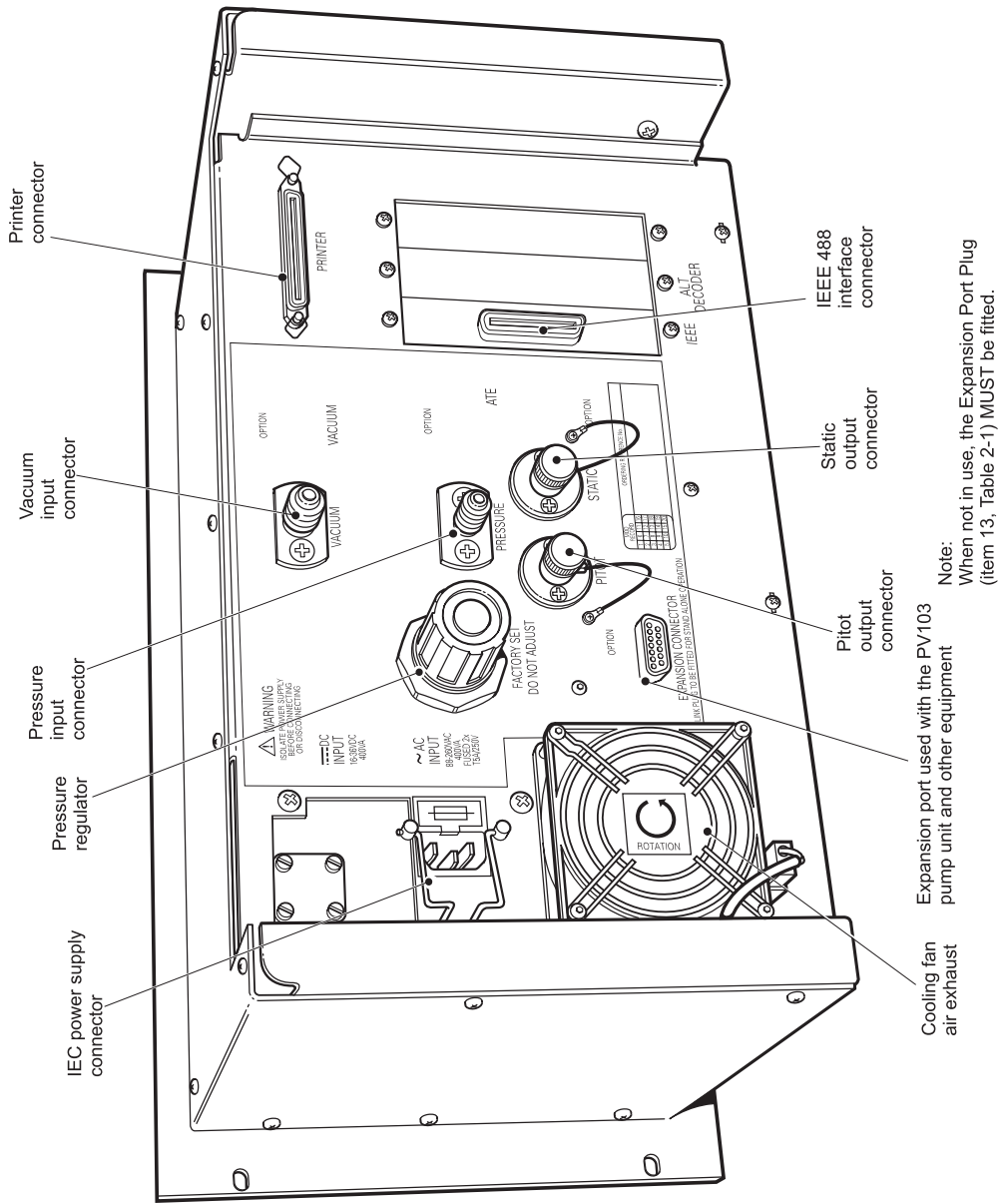

FIGURE 2-5 ADTS 405 REAR PANEL VIEW

Expansion port used with the PV103 pump unit and other equipment

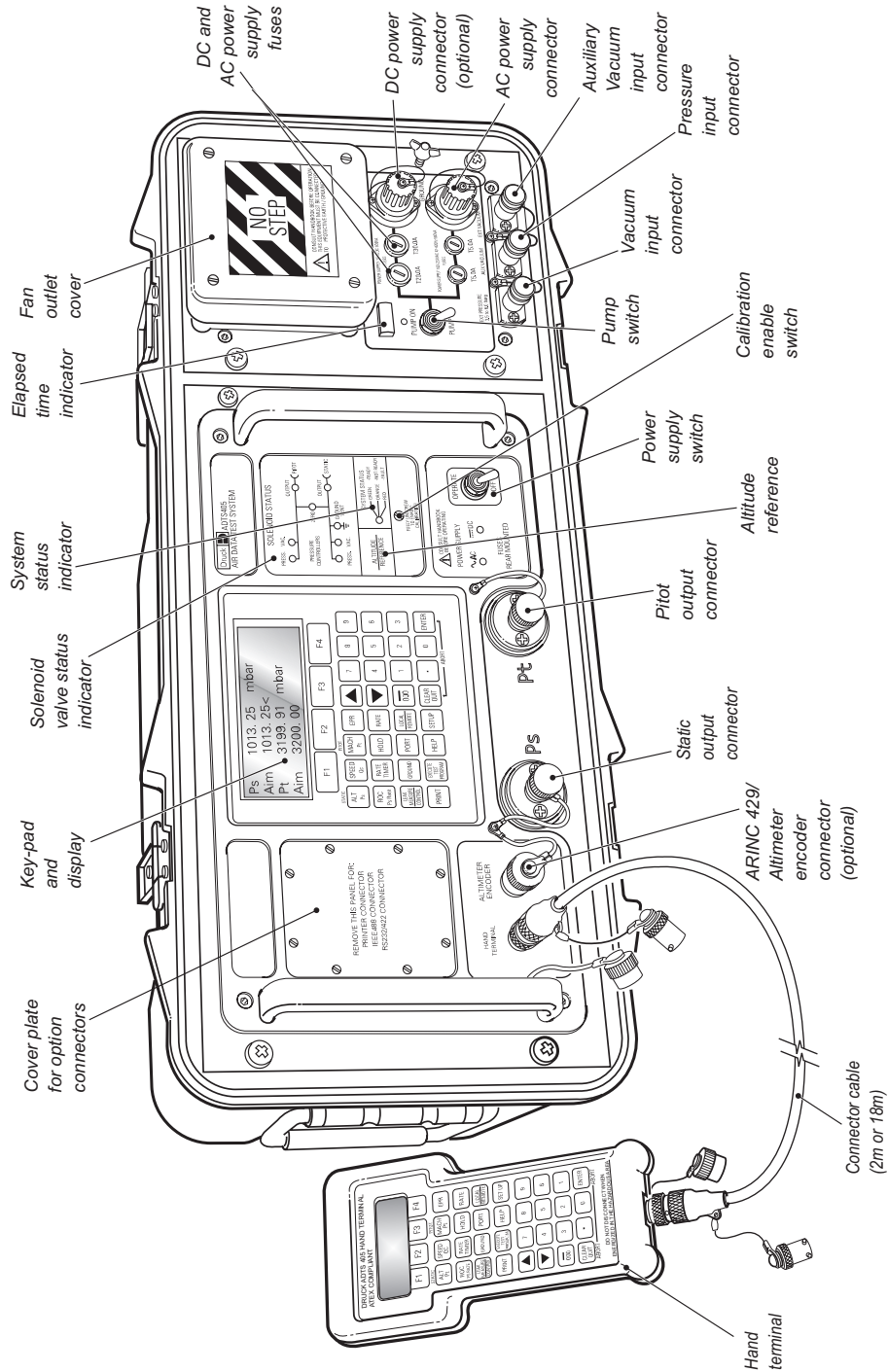

FIGURE 2-6 ADTS 405F GENERAL VIEW

## 3 OPERATION

### 3.1 Preparation

#### WARNING:

#### OBSERVE SAFETY PRECAUTIONS STATED IN LOCAL ORDERS AND THE AIRCRAFT OR EQUIPMENT SERVICING PROCEDURES.

- Make sure the electrical and pneumatic connectors, electrical cables and pipes and positioning of the ADTS 405 comply with the instructions and requirements in Section 2 Installation.
- Carry out the following before use:
  - ▢ If necessary, carry out the maintenance task detailed in Section 4.
  - ▢ Make sure the air data test system power supply switch on the front panel is set to OFF. Connect the air data test system to the electrical supply, make sure the supply includes a connection to a protective earth.
  - ▢ Inspect the pneumatic hoses for damage, ingress of dirt and moisture. Make sure the aircraft adaptors are serviceable.
- Connect, to the air data test system, the hoses necessary for the test procedures to be carried out: red hose to the STATIC output (Ps), blue hose to the PITOT output (Pt). Temporarily seal the free ends of the hoses.  
**Note:** *When connected, take care not to kink or stand on the hoses.*
- Connect the hand terminal to the air data test system through the HAND TERMINAL connector on the front panel. If necessary, connect the hand terminal through the extension cable.
- Before use, the ADTS 405 should be tested, for first time users see section 3.4, for users requiring more operating detail see section 3.5.
- This section contains a quick reference chart showing all the functions of the key-pad. Further quick reference charts show the set-up and configuration settings for each key-pad function.
- Review and become familiar with the whole procedure before starting the test process on an aircraft or component.

### 3.2 Display Functions and Units of Measure

- When operating in either pressure measuring or pressure controlling modes, the ADTS 405 can display the following information:

Aeronautical Functions	Display Abbreviation	Displayed Units <small>(if applicable)</small>
Altitude	ALT	ft, m
Calibrated and True Airspeed	CAS, TAS	kts, km/h, mph
Mach	MACH	-
Rate of Climb	ROC	ft/m, m/m, m/s, hm/m
Rate of Airspeed	Rt CAS,	kts/m, km/h/m, mph/m
Rate of Mach	RtMCH	Mach/m

Pressure Functions	Display Abbreviation	Displayed Units <small>(if applicable)</small>
Static (Absolute)	Ps	[P]
Pitot (Absolute)	Pt	[P]
Dynamic or Impact (Differential)	Qc	[P]
Engine Pressure Ratio	EPR	-
Rate of Ps	Rt Ps	[P] /m
Rate of Pt	Rt Pt	[P] /m
Rate of Qc	Rt Qc	[P] /m
Rate of EPR	Rt EPR	EPR/m

Where [P] is the currently selected pressure units from the following list:  
 mbar, inHg, mmHg, inH<sub>2</sub>O (4°C), inH<sub>2</sub>O (20°C), psi, hPa, kPa, inH<sub>2</sub>O (60°F), kg/cm<sup>2</sup>, %FS

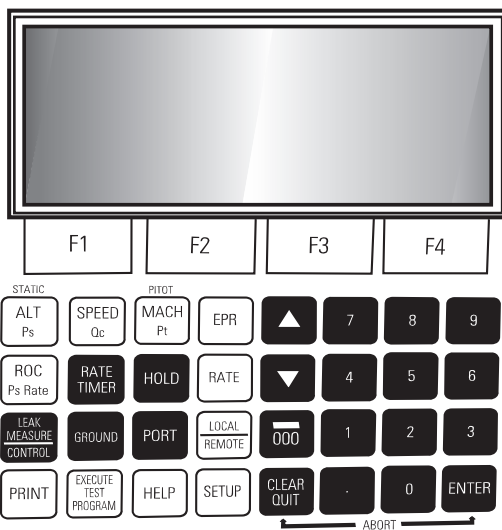

FIGURE 3-1 FRONT PANEL

### 3.3 Quick Reference

The quick reference chart shows normal operation key functions. In the key/selection column the following applies:

- **ALT**
- **[NEXT]**
- **(SINGLE DOUBLE)**
- **(craft1 craft2...)**
- **data entry**
- **Key.**
- **Item in menu (soft key).**
- **Sequence of parameters selected by NEXT key.**
- **Sequence of names selected by NEXT key.**
- **Enter number from key-pad.**

#### KEY-PAD FUNCTION

##### Key/selection

F1-F4

ALT Ps  
SPEED Qc  
MACH Pt  
EPR  
ROC Ps RATE  
RATE TIMER

├ F1  
├ F2  
└ F3

HOLD  
RATE

LEAK MEASURE/CONTROL

GROUND

├ [GO TO GROUND]  
├ [DISPLAY QFE]  
└ [DISPLAY QNH]

PORT

REMOTE  
PRINT

├ [ALPHA]  
├ [BACK]  
└ data entry

EXECUTE TEST PROGRAM

├ [NEXT]  
├ [PREV]  
├ [RUN]  
├ F1  
└ F2

HELP

SETUP

See QUICK REFERENCE -  
SETUP or MINIMUM SETUP

SETUP + F1

See QUICK REFERENCE - CONFIG

▲ (nudge up)

▼ (nudge down)

0-9

-000

CLEAR/QUIT

ENTER

CLEAR/QUIT + ENTER

the display shows the main pressure display (Leak Measure or Control mode).

##### Function and comments

Function keys for menus

Altitude (Aeronautical units) or Ps (Pressure units)  
Airspeed (Aeronautical units) or Qc (Pressure units)  
Mach (Aeronautical units) or Pt (Pressure units)  
Engine Pressure Ratio (pressure units only)  
Rate of Climb (Aeronautical units) or Rate of Ps (Pressure units)  
Start timing rate of change  
Wait and time choice 1  
Wait and time choice 2  
Wait and time choice 3  
Hold pressure at present value - Press again to release  
Rate of change of Pitot parameter - Press Pitot parameter then RATE  
Switches between measure mode (for leak testing) and control mode

Controls Ps to atmospheric pressure and Qc to zero at current rates of change  
Display local atmospheric (ground) pressure  
Display sea level equivalent of local atmospheric pressure

See Line Switching Unit User Manual  
Switches (toggles) between remote and local operation  
Prints current parameter values  
Inserts alphabet character in user text  
Deletes last character of user text  
Numeric entry for user text

Execute down-loaded Test Programs  
Select next listed test program  
Select previous listed test program  
Execute selected test program  
Execute all tests in the test program  
Selects and executes a specific test program  
Press HELP then other key for further information  
Temporary set-up - lost at power down

Configuration - changes power-up defaults  
Hold F1 while pressing SETUP - then enter PIN

Increases aim value  
Decreases aim value  
Number entry  
Minus sign for first number entry 000 (thousand) if not first number of entry  
Clear number entry - quit from menu or clear warning message  
Complete number entry  
ABORT - restart with power-up

### 3.4 First Time Operators

- The following sequences of operation should be used by first time operators and by operators that use the equipment occasionally. For regular users, familiar with the equipment, go to section 3.5. Set the power supply switch to OPERATE and the power-up routine starts.

- (1) The display, on the front panel or hand-terminal, shows:

```
DK126   Iss 1.xx
Display Power Up
Please Wait
```



- (2) After a short time the display shows:

```
DRUCK
ADTS 405
DK263
VER 6.xx
```

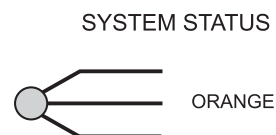

**Note:**

Where  $x$  is the current issue number of the software.

- (3)

```
Last Calibration
dd/mm/yy (dmy)
RPT Transducer
PLEASE WAIT
```

**Note:**

Date format can be changed in configuration.

For units fitted with the Solartron transducer, the display shows Solartron Transducer in place of RPT Transducer.

- (4)

```
Self Test
PLEASE WAIT
```

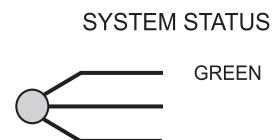

- (5) The system opens the zero valves and after approximately 7 seconds the valves close and the routine continues with the display shows:

```
Measuring Ground
Pressures

PLEASE WAIT
```

- (6) The system opens the output valves and controls pressures at the original measured values.

```
Equalising System
Pressures
(Valves May Pulse)
PLEASE WAIT
```

- (7) At switch on, check the hand-held terminal display.

**Note:**

*The ADTS 405 is a continuous, self-monitoring system. If the system detects an error, the display shows an error message. Lists of errors are detailed in Section 5, Fault Finding and Testing.*

```
ALT      0      ft
Leak Measure

WARMUP
```

**Note:**

*Wait 15 minutes, before continuing, to allow the system to get to thermal stability. The wait time can be reduced to 5 minutes if the system has been re-powered after a short time.*

**Operating modes**

- The air data test system can now be set for a variety of functions and modes. In the following, examples of measure mode, control mode, leak measure mode and go-to-ground show the key presses and selections required for each mode.

Measure Mode

To select the measured parameter press:

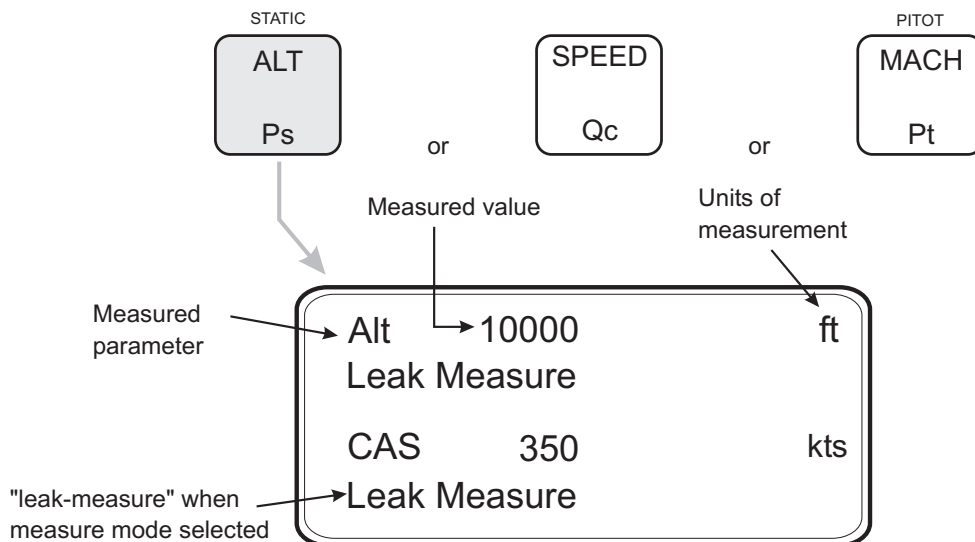

Change display single, dual or triple press:

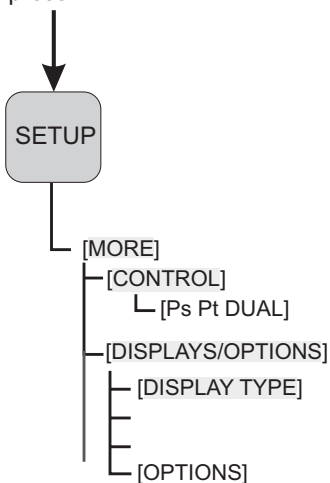

Change units from aeronautical to pressure:

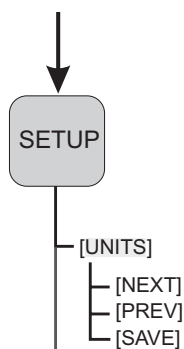



### Control Mode

For ADTS 405F set the pump switch to PUMP ON.



From leak measure mode press:

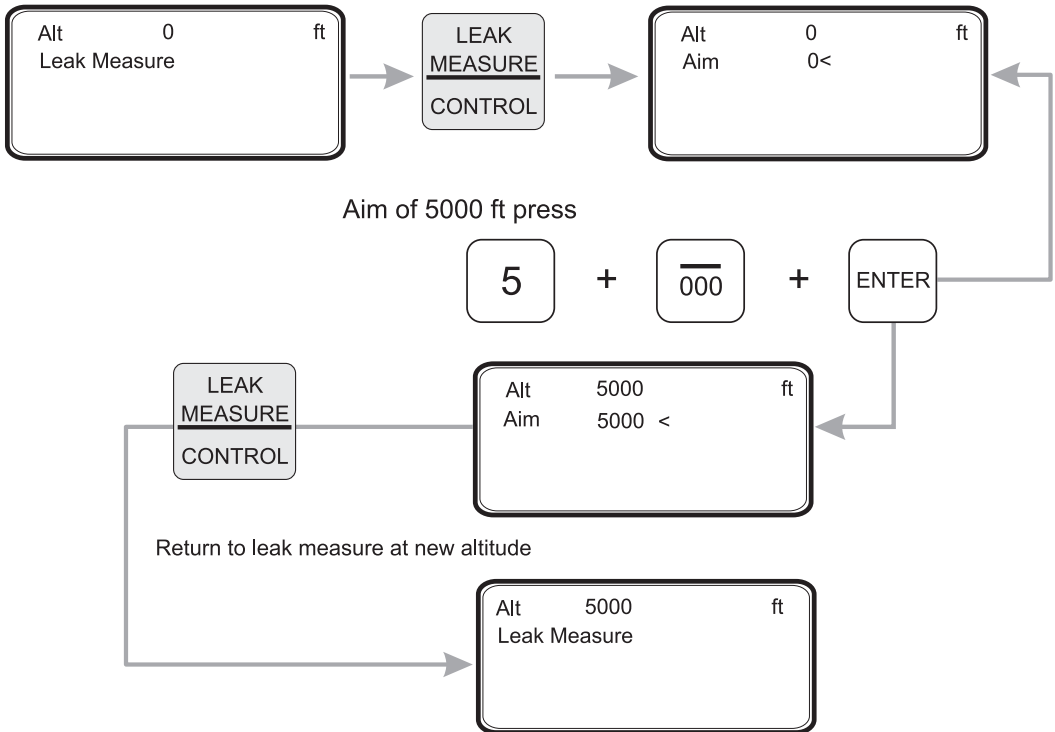

## Leak Measure Mode

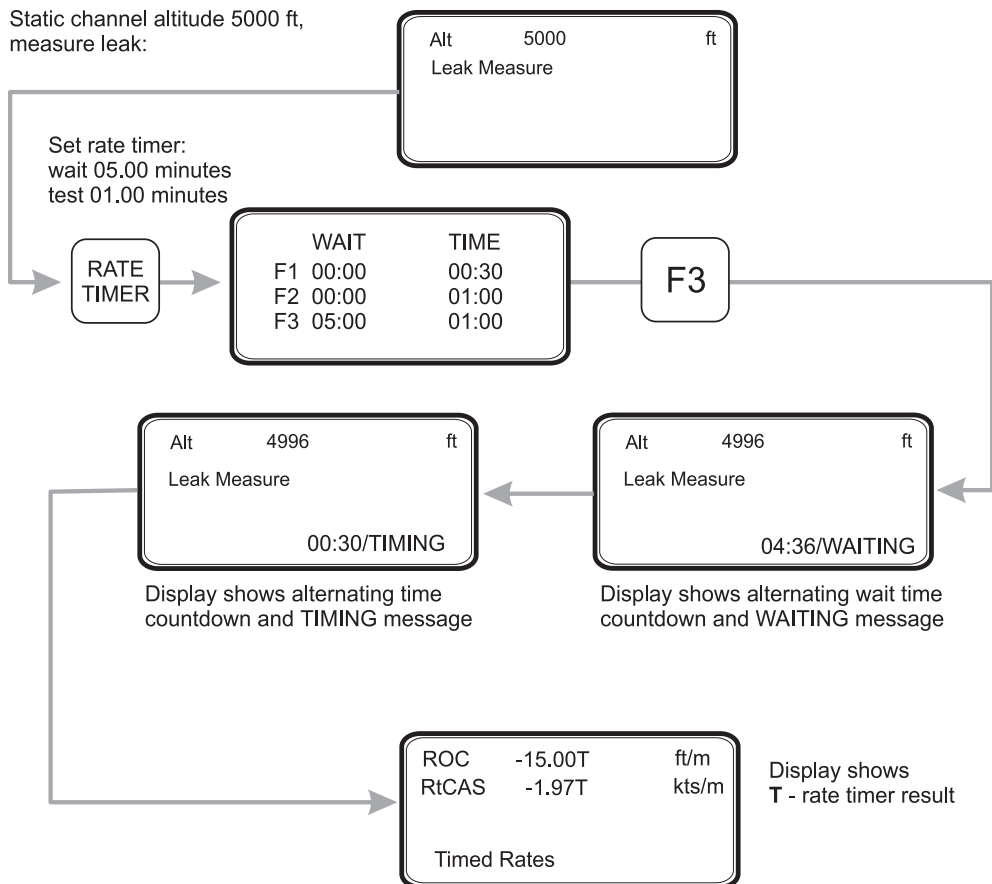

**Note:** Compressing a gas generates heat. Gas heated or cooled in an enclosed volume causes a pressure change. It is important, especially for leak testing, to allow enough time for the heated gas to cool and the pressure to stabilize. When setting the rate timer consider three factors:

- 1 The volume of the system to be tested (large volumes take longer to stabilize).
- 2 The pressure change (the higher the change the greater heat generated).
- 3 The ambient air temperature.

Go to Ground

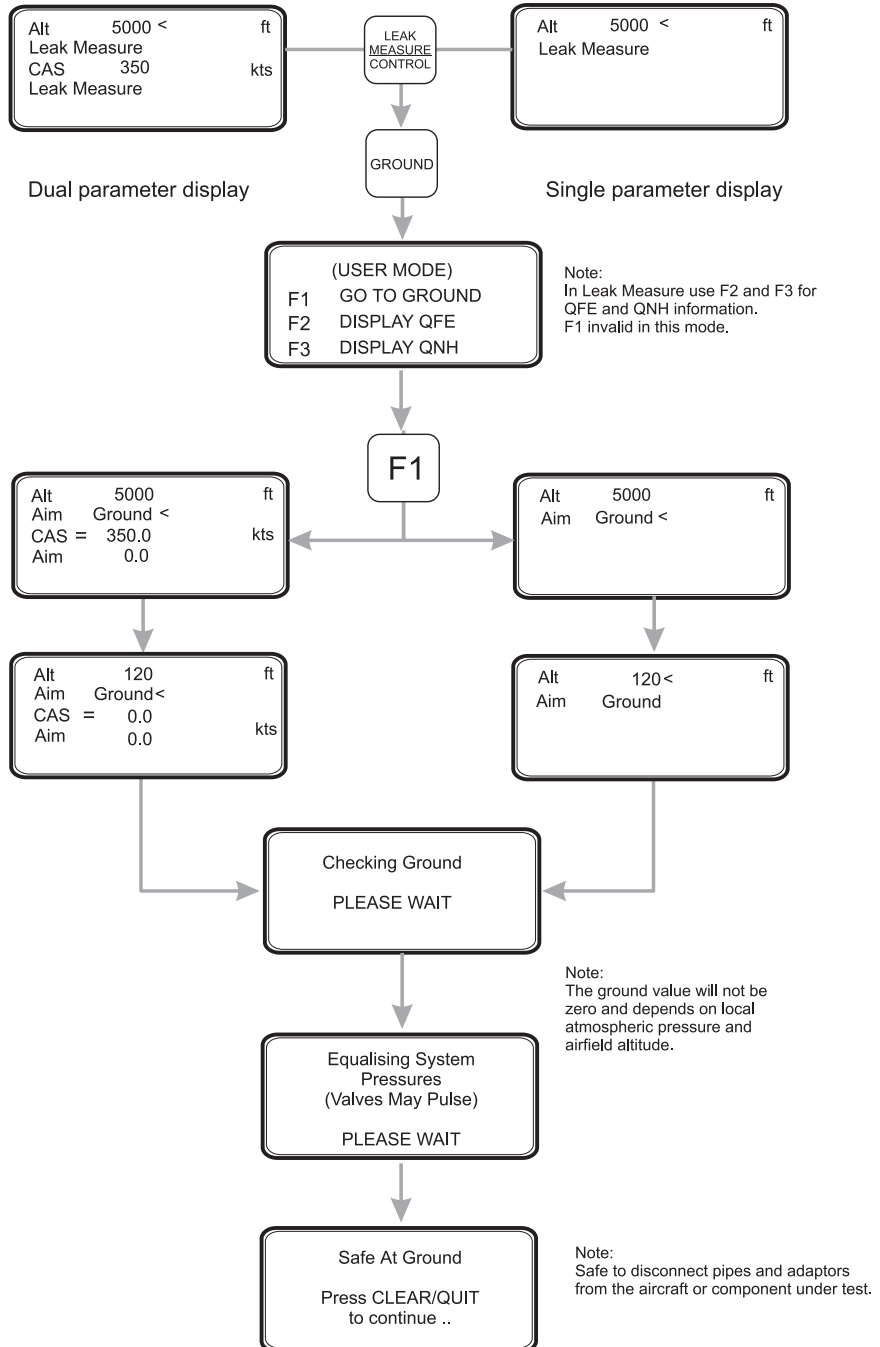

## 3.5 Operation and Example Procedures

### 3.5.1 Checks Before Use

- Inspection and Cleaning

Inspect the external of the ADTS 405, and its associated equipment, for damage, dirt, and the ingress of moisture. If necessary, use foam cleaner and a lint-free cloth to clean the external surfaces.

Inspect the pressure outlet ports for ingress of dirt and moisture, clean if necessary with a lint-free cloth.

### 3.5.2 Operating Procedures

- The procedures show the steps required to make sure the ADTS 405 is serviceable and the settings required to test an aircraft system or component. For further information refer to the quick reference charts, at the end of this section, and Section 6 - Reference and Specification.

In the following:

- All key presses are highlighted in **bold** and shown as identified on the key-pad.
- Key presses inside brackets e.g., [MORE], are soft key presses (i.e., function key selections {F1 to F4} indicated on the display screen).

#### Help System

- The help information includes further details of the function and details associated functions, also see the Reference Section 6.

## 3.6 Power-up

- Check the power indicator is illuminated and set the front panel power switch to OPERATE.
- The display shows the following sequence:
  - a. Display power-up screen.
  - b. ADTS 405 power-up screen.
  - c. Date of the last calibration and type of main transducer fitted.
  - d. Self-test message.
  - e. Measuring ground pressure message.
  - f. Equalising system pressures message.
  - g. Display shows Leak Measure mode and the number of parameters last selected in configuration.
- The ADTS 405 always powers-up in Leak Measure mode with the pressure controllers off. When changing to Control Mode the pump unit must be switched on and producing the correct pressure and vacuum.

**Note:** *The display at power-up can be changed, see CONFIGuration.*

- The ADTS 405 system may now be used but for full specification accuracy and stability, wait the "WARMUP" period of 15 minutes. The display shows "WARMUP" in the lower right hand corner, this message clears automatically after the time period.

### 3.7 Control or Measure Parameter

- To change the displayed parameter:
  - Value parameters - Press the parameter key  
e.g., press **SPEED/Qc** to display airspeed.
  - Rate parameter - Press the associated parameter key followed by the rate key for that channel. e.g., display airspeed rate, press **SPEED/Qc** then **RATE**. **ROC/Ps Rate** may be directly pressed without first pressing **ALT/Ps**.

**Note:** *The displayed parameters depend on the last keys pressed.*

- To display two parameters:
  - ▢ Press each value parameter in turn.  
e.g., display altitude and airspeed together, press **ALT/Ps** then **SPEED/Qc**.
  - ▢ In control mode, an arrow, at the right-hand end of the aim value, indicates the last parameter selected. This can be changed by entering a new value.
- To display a value parameter together with its rate:
  - ▢ Press the parameter key followed by the associated rate key.  
e.g., display airspeed and rate of speed together, press **SPEED/Qc** then **RATE**.  
See Rate set-up for display details.

**Note:** *If **ROC/Ps Rate** is pressed, the display automatically shows **ALT** and **ROC**.*

### Aim

- A new aim can be entered using the numeric keys. Each digit is displayed as it is pressed. The existing aim is replaced when the first digit of the new aim is pressed. If an error is made during the entry of data, press **CLEAR/QUIT** to restore the original aim.
- Press **ENTER** to action the new aim.

**Note 1:** *The **000** key can be used as a quick way of entering thousands.*

**Note 2:** *The ADTS 405 must be in control mode to enter a new aim (current aim displayed). If the aim field shows "Leak Measure" press **LEAK MEASURE/CONTROL** to enter control mode.*

### 3.8 Leak Testing the ADTS 405

- It is important to check that the ADTS 405 and the connecting equipment does not leak. Before use a leak check should be carried out as follows:
- Connect the pitot and static hoses (to front panel of ADTS 405F). Temporarily seal the free ends of the hoses.
- Set the display to dual display, see 3.9.
- Set the units to feet and knots, see 3.13.
- Using the **SETUP** menu, choose the limits set for the aircraft or UUT, see 3.14.
  - ▣ Press SETUP, [LIMITS], and [NEXT] repeatedly to select the limit set from those available.
  - ▣ Press [SEL] to save and then press **CLEAR/QUIT** repeatedly until the main pressure screen shown below is displayed.

**Note:**

*The numeric value of the parameters displayed change with each power-up sequence. The amount of change depends on local atmospheric pressure conditions at the time of power-up.*

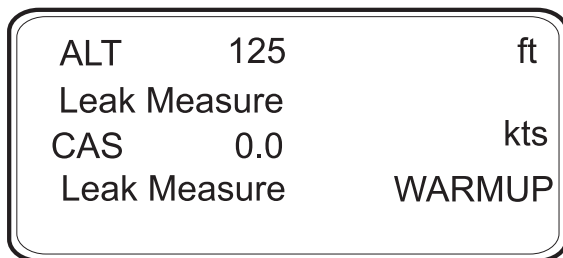

**FIGURE 3-2 MAIN PRESSURE DISPLAY (LEAK MEASURE MODE)**

- Press the **LEAK MEASURE/CONTROL** key to turn on the pressure controllers.

- To apply an altitude of 5000 ft at a rate of climb of 6000 ft/min and an airspeed of 300 kts at a rate of 600 kts/min press the following keys:
  - ▢ **SPEED/Qc** then **RATE** to select rate of change of speed.
  - ▢ **6, 0, 0, ENTER** to set the rate.
  - ▢ **SPEED/Qc** to select airspeed.
  - ▢ **3, 0, 0, ENTER** to set an airspeed of 300 kts (airspeed [CAS] now starts increasing).
  - ▢ **ROC/Ps Rate** to select rate of climb.
  - ▢ **6, 0, 0, 0, ENTER** to set the rate of climb.
  - ▢ **ALT/Ps** to select the altitude.
  - ▢ **5, 0, 0, 0, ENTER** to set altitude (altitude [Alt] now starts increasing).
  - ▢ **SPEED/Qc** to view altitude and airspeed together.

**Note:**

*When altitude and airspeed are changing at the same time, and automatic airspeed rate is enabled, the system automatically adjusts the airspeed rate so that the aim points are reached at the same time. The airspeed rate will not exceed the entered aim value.*

- ▢ Wait for the aim values to be achieved.
  - ▢ Observe over a period of 1 minute that the value of Alt stays within  $\pm 10$  ft and the value of CAS with  $\pm 1$  kt.

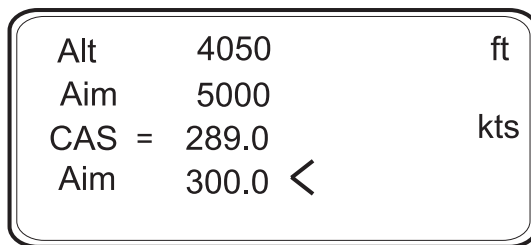

**FIGURE 3-3 MAIN PRESSURE DISPLAY (CONTROL MODE)**

## Leak Measure

**Note:** *Compressing a gas generates heat. Gas heated or cooled in an enclosed volume causes a pressure change. It is important, especially for leak testing, to allow enough time for the heated gas to cool and the pressure to stabilize.*

- ▣ Press **LEAK MEASURE/CONTROL** to return to Leak Measure mode.
- ▣ Press RATE TIMER, F3 - [Wait 05:00, Time 01:00].

**Note:** *Different wait and time periods can be selected by pressing F1 or F2.*

- ▣ Wait until rate timer has completed and the results displayed.
  - ▣ Check rate of climb is less than  $\pm 100$  ft/min and rate of airspeed (CAS) is less than  $\pm 1$  kt.
  - ▣ Press **LEAK MEASURE/CONTROL** to return to Control mode.
  - ▣ Press **GROUND**, F1, [Go to Ground].
  - ▣ Wait until for the display shows **Safe At Ground**.
- After a successful leak test, the ADTS 405 is now ready to be connected to an aircraft system or unit under test.
  - After an unsuccessful, first-time leak test, leave the system to achieve thermal stability for a further five minutes, press **CLEAR/QUIT** and repeat the leak test. If the leak test is now successful, the ADTS 405 is now ready to be connected to an aircraft system or unit under test.
  - After another unsuccessful leak test, disconnect both hoses, check the condition of the o-rings on the Ps and Pt connectors as detailed in the maintenance section and firmly replace the blanking caps. Press **CLEAR/QUIT** and repeat the leak test procedure.
  - After a successful leak test without hoses connected, replace or repair the faulty hose(s) and retest. If the ADTS 405 fails the leak test without hoses connected, switch off and return the unit to the repair depot.



### 3.9 Displays (Fig 3.4, Fig 3.5 and Fig 3.6)

- The display normally shows pressures and rates or aeronautical equivalents. It can be set-up to show, at the same time, one parameter (single), two parameters (dual) or three parameters (triple). The ADTS 405 automatically returns to the pressure display if left inactive in any set-up or menu type display for a period of more than one minute.
- The triple display always shows altitude and airspeed; with pressure units selected, the display always shows Ps and either Qc, Pt or EPR. When **ALT** or **CAS** are selected the display shows the aim and measured values of **ALT** and **CAS** as a dual display. With any other selected parameter the display shows the measured values of altitude and airspeed and, the aim and measured value of the other selected parameter.
- Additional display modes are available for options.

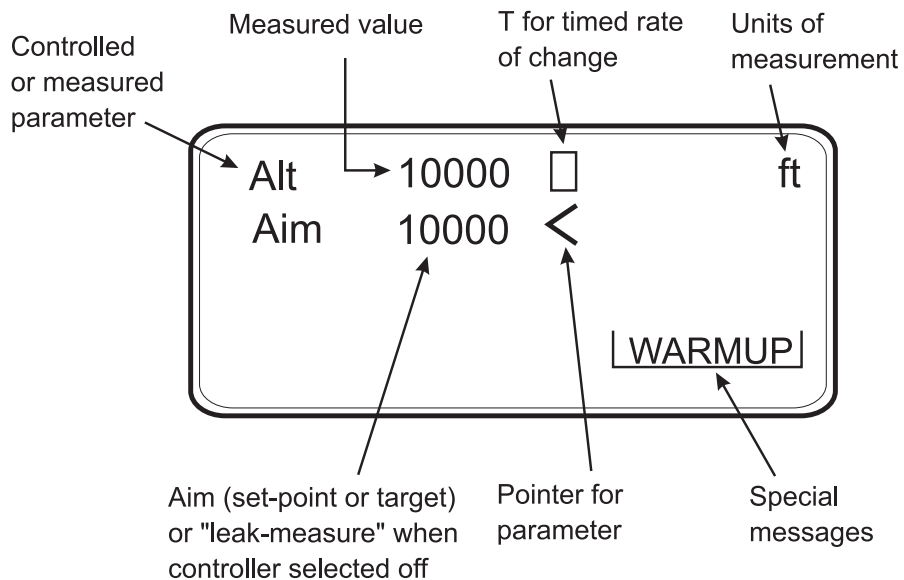

FIGURE 3-4 SINGLE DISPLAY

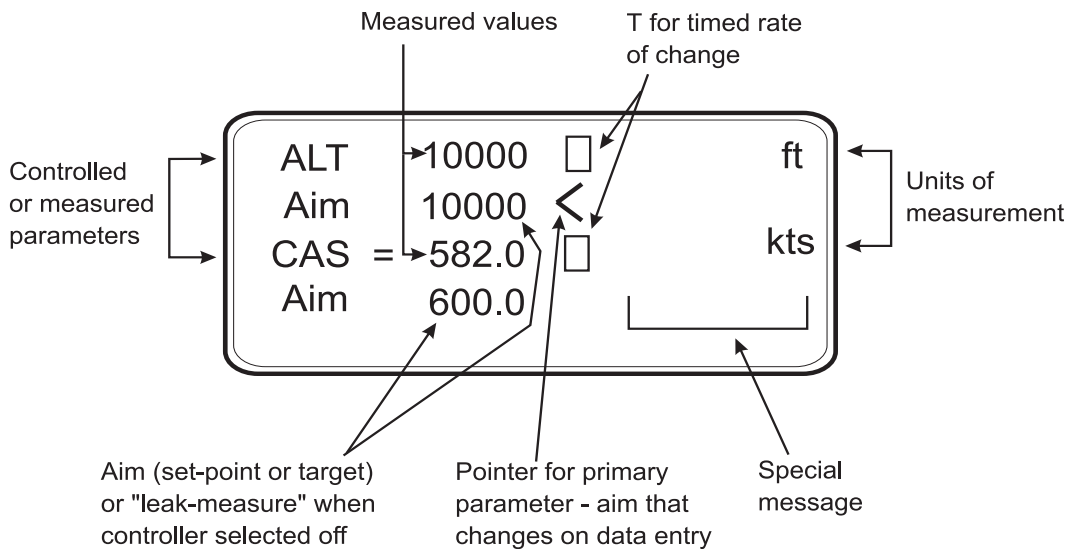

FIGURE 3-5 DUAL DISPLAY

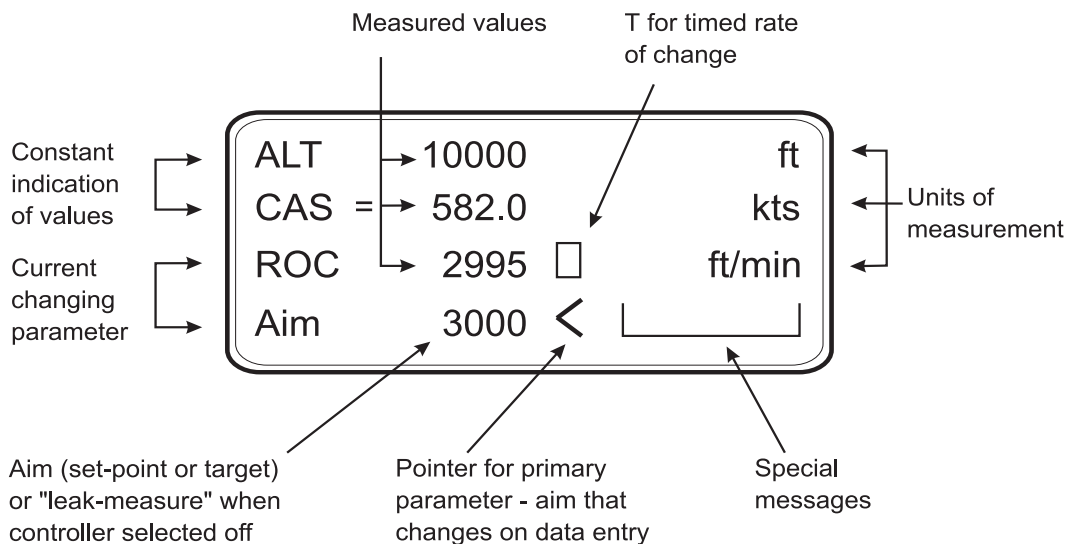

FIGURE 3-6 TRIPLE DISPLAY

### 3.10 Rate Timer Displays (Fig 3.7 and Fig 3.8)

- When in Leak Measure mode and, after completing a rate timing, the system generates the rate timer displays. These displays do not depend on the display mode (single, dual, triple or option). Pressing a parameter key (**ALT**, **ROC**, etc.) or **CLEAR/QUIT** exits the rate timer displays.

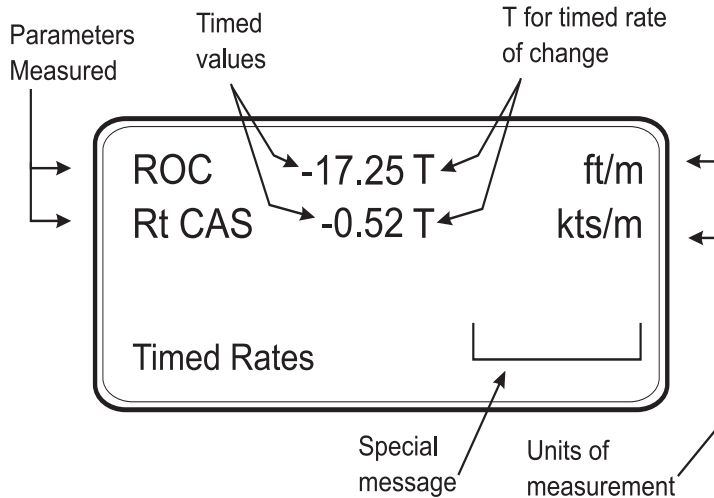

FIGURE 3-7 RATE TIMER DISPLAY AERONAUTICAL UNITS

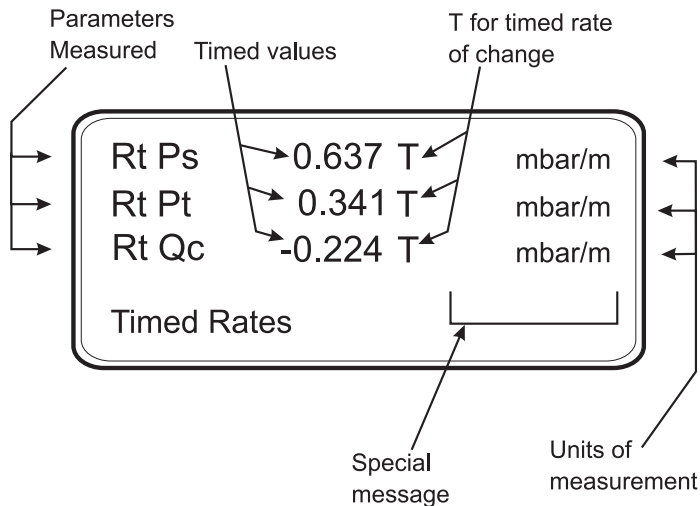

FIGURE 3-8 RATE TIMER DISPLAY PRESSURE UNITS

**Note:** There is no pointer for the primary parameter, values cannot be entered in the rate timer displays.

### 3.11 Pt Only Display (Fig 3.8)

- The Pt only display overrides the other display modes (single, dual and triple). The measured altitude and the CAS are produced from Ps in measure mode.

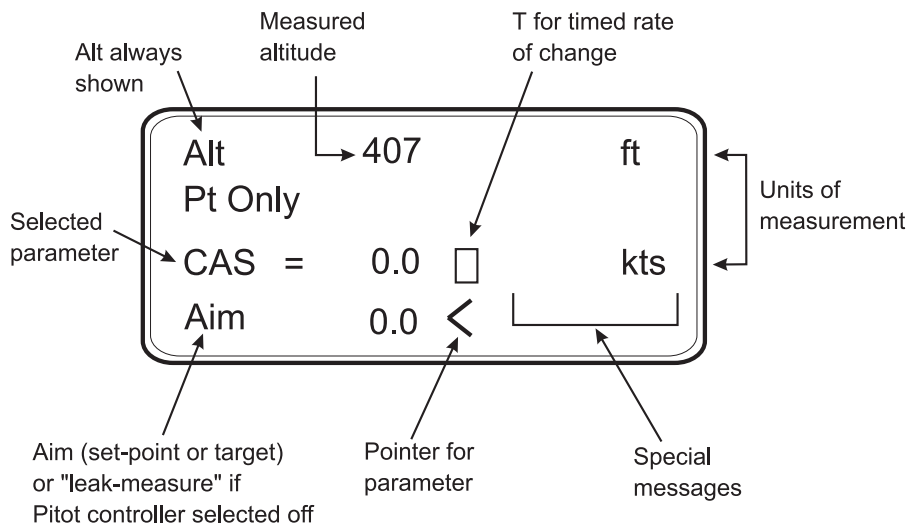

FIGURE 3-9 Pt ONLY DISPLAY

### 3.12 Changing the Display

- The display can show either one, two or three parameters as follows:  
**Note:** Display cannot be changed with **SETUP** switched off or in minimum mode.
- To change the display:
  - Press **SETUP**.
  - Select [MORE].
  - Select [DISPLAYS/OPTIONS].
  - Select [DISPLAY TYPE].
  - Using [NEXT] or [PREV].
  - Select either SINGLE, DUAL or TRIPLE, ARINC, ENCODER (*more display types with options fitted*).
  - Press [SAVE] to accept.
  - Press **CLEAR/QUIT** repeatedly to return to user display.
- To change the display for Pt Only:
  - Press **SETUP**.
  - Select [MORE].
  - Select [Control], [Ps Pt Dual].
  - Select [Pt Only Mode].
  - Press **CLEAR/QUIT** repeatedly to return to user display.

### 3.13 Changing the Units

- The units can be changed to units of pressure measurement or aeronautical units.
- In Full Set-up Mode any set of aeronautical or pressure units can be selected.
- To change the units:
  - ▢ Press the **SETUP** key.
  - ▢ Select [UNITS].
  - ▢ Use [NEXT] and [PREV] keys to select the required units.
  - ▢ Select [SAVE] to accept.
  - ▢ Press **CLEAR/QUIT** repeatedly to return to the main pressure display.
- In Minimum Setup Mode only the default aeronautical and pressure units can be selected.
- To change the unit type:
  - ▢ Press the **SETUP** key.
  - ▢ Select [UNITS TYPE].
  - ▢ Select either [AERO] or [PRESS] to select the unit type.
  - ▢ Select [SAVE] to accept.
  - ▢ Press **CLEAR/QUIT** repeatedly to return to the main pressure display.

**Note:** *The default pressure and aeronautical units are defined in the CONFIGuration mode.*

- If Set-up Mode is switched off, units cannot be changed.

### 3.14 Limit Checking

- The system checks all data entered against minimum and maximum limits set for the particular limit set in use. If these limits are exceeded, the data entry is ignored and a warning message displayed showing the minimum and maximum values that can be entered. The system also checks all limits of associated parameters. If these limits are exceeded when a new value is entered, the display shows the name of the associated parameter.  
e.g., If a Mach limit is exceeded when entering an airspeed value the display shows "Mach" and the equivalent maximum and minimum limits as airspeed values. Similarly, if an ARINC 565 limit is exceeded when entering a value and, ARINC limits are enabled, the display shows 'ARINC'.

- Using the SETUP function, previously stored sets of limits can be recalled for use. Each set of limits is stored under an aircraft name. Three pre-defined sets of limits "Standard", "Civil" and "Max" limits are supplied with the ADTS 405.

**Note:** *The ADTS 405, when delivered, contains "Standard" and "Civil" limits; to set and store "Max" limits, for the first time, enter configuration. The "Max" limits depend on the range of the pitot channel either 850 or 1000 knots, see section 1.3, operating limits.*

#### To select the limits in use:

- ▢ Press **SETUP**.
  - ▢ Select [LIMITS].
  - ▢ Use [NEXT] or [PREV] to select the limits required. Each set of limits is identified by its name, including the pre-defined sets of limits ("Standard", "Civil" and "Max" see section 1.3, operating limits).
  - ▢ Select [SEL] to select the limits.
  - ▢ Press **QUIT/CLEAR** to return to the pressure display.
- Using the CONFIGURATION function, new sets of limits can be created and existing sets of limits can be edited. In addition, the set of limits in use at power-up can be selected. If required, this selection can be locked to prevent unauthorised changing of the limits.

#### Auto recovery facilities

- The pressure controllers in the ADTS 405 can "feed" a leak in an aircraft system. When first testing an aircraft system, a leak test must be carried out at low altitude and airspeed.
- If, during a leak test, a leak in the system produces a rate of climb greater than the rate set in limits or a rate of change of airspeed greater than the rate set in limits, then the pressure controllers automatically regain control to minimise damage to the aircraft system. This AUTO LEAK RECOVERY facility can be disabled.
- If a leak causes the system pressures to exceed any limit during a leak test, the pressure controllers automatically regain control. This AUTO LIMIT RECOVERY system can be disabled.
- If negative airspeed (or Qc) occurs in measure mode, the zero value is automatically opened for one second to balance the airspeed. This only applies when the minimum CAS (or Qc) limit is zero.
- Limits cannot be changed with SETUP switched off or Limit Lock enabled.

### Aircraft System Protection

- The ADTS 405 protects the aircraft system against user error and leaks in the aircraft system.

**Note:** *The pumps must be switched on.*

The system protection operates:

- ▣ Limit checking of user entered set-points.
- ▣ Automatic regain of control if leak rate is over limit during leak testing.
- ▣ Automatic regain of control if a leak takes the system pressures outside of limits.

### Mach Test and Constant Mach

- To go to 0.8 Mach, enter Control Mode and proceed as follows:
  - ▣ Press **SPEED** then **RATE** to select rate of change of airspeed.
  - ▣ Enter required rate, e.g. 300 kts/min.
  - ▣ Press **MACH**.
  - ▣ Enter 0.8.
  - ▣ Wait for the Mach to be achieved.

**Note:** *If the altitude changes the system automatically adjusts the airspeed to keep the Mach value constant.*

### True Airspeed

- The normal airspeed parameter is Calibrated Airspeed (CAS) (equivalent to IAS for testing purposes).

- The airspeed parameter may be changed to True Airspeed (TAS) as follows:
  - ▣ Press **SETUP** then **SPEED**.
  - ▣ Select [CAS/TAS].
  - ▣ Select [TAS].
  - ▣ Press **QUIT/CLEAR** repeatedly to exit set-up.
  - ▣ Press **SPEED**.

- The display now shows the airspeed parameter as TAS.

**Note:** *Airspeed parameter type can only be changed in Full Set-up mode. Rate of change of airspeed will still be shown as Rate CAS.*

- Pitot temperature ( $\theta$ t) is used in the calculation of TAS. To enter  $\theta$ t:
  - ▣ Press **SETUP**.
  - ▣ Press **SPEED**.
  - ▣ Select [Pt TEMPERATURE].
  - ▣ Enter the temperature measured by the aircraft's Pitot temperature sensor.
  - ▣ Press **QUIT/CLEAR** three times to return to user display.

**Note:** *Pitot temperature can only be changed in Full Set-up mode.*

### Airspeed Switch test

- The following example shows how an airspeed switch can be functionally checked.  
**Note:** For low airspeed switches (i.e. 130 knots) the Pt Only facility could be used.
- Press **LEAK MEASURE/CONTROL** to enter control mode. Press **SPEED/Qc**.
- If necessary, press **RATE** and enter a change of airspeed low enough to observe switch operation.
- Enter an Aim value below the operating limits of the switch (i.e., airspeed switch operating at 130 knots  $\pm$ 2 knots set 127 knots).
- Press **ENTER** and observe the airspeed changing.
- Using the nudge facility, set to an appropriate step value, increase the Aim value.
- Increase the Aim until the switch operates (contacts close) and record the value.
- Change the Aim to above the airspeed operating range (i.e. 133 knots). Repeat the steps, decreasing the Aim value until the airspeed switch operates (contacts open) and record value.
- This procedure can be repeated. If many operations of a switch are required use the oscillating facility detailed in Full Set-up. The above method can be used for the other parameters:

**Examples:**

Altitude switch	-	low altitude warning
	-	landing gear configuration warning
	-	height lock
Mach switch	-	Speed brake scheduling
	-	Mach cruise lock



### Engine Pressure Ratio (EPR)

- The ADTS 405 may be used to check EPR sensors and indicators. Use Ps for INLET pressure and Pt for OUTLET pressure.
- To carry out an EPR check, the display must be showing pressure units e.g., mbar or inHg.
- To change units in FULL SETUP Mode:
  - ▣ Press **SETUP**.
  - ▣ Select [UNITS].
  - ▣ Select required pressure units for display using [NEXT], [PREV] and [SAVE].
  - ▣ Use **CLEAR/QUIT** to return to pressure display.
- To change units in MINIMUM SETUP Mode:
  - ▣ Press **SETUP**.
  - ▣ Select [UNITS TYPE].
  - ▣ Select [PRESS].
  - ▣ Use **CLEAR/QUIT** to return to the main pressure display. Pressure units cannot be selected when set-up mode is switched off.
- To enter an EPR of 1.8 with inlet pressure of 500 mbar (15 inHg), proceed as follows:
  - ▣ If the display shows "Leak Measure", press **LEAK MEASURE/CONTROL** to regain control.

**Note:** *The pressure/vacuum pumps must be switched on.*

- ▣ Press **ROC/Ps RATE** to select rate of change of static.
- ▣ Enter required rate of change e.g., 1000 mbar/min, (30 inHg/min).
- ▣ Press **EPR** then **RATE** to select EPR rate.
- ▣ Enter required value e.g., 5 EPR/min and press **ENTER**.
- ▣ Press **ALT/Ps**.
- ▣ Enter 500 mbar (15 inHg) and press **ENTER**.
- ▣ Press **EPR**.
- ▣ Enter 1.8 and press **ENTER**.
- ▣ An EPR of 1.8 will quickly be achieved.

**Note:** *EPR testing can also be performed by specifying the actual INLET and OUTLET values.*

### 3.15 Testing Aircraft Systems or UUT

**WARNING: OBSERVE THE APPROPRIATE SAFETY INSTRUCTIONS AND PROCEDURES DETAILED IN THE AIRCRAFT MAINTENANCE MANUALS OR COMPONENT MAINTENANCE MANUALS.**

- Connect the hoses and appropriate adaptors to the aircraft system or UUT.
- To make sure that the connections to the aircraft system or UUT are not leaking carry out a leak test detailed in the appropriate aircraft or component manual.

#### 3.15.1 Go To Ground and Shut-down

- On completion of testing and, before disconnecting from the aircraft system or UUT, the pressures in the system must be taken to the local atmospheric pressure (ground) with zero airspeed.
  - ▢ If the display shows "Leak Measure", press **LEAK MEASURE/CONTROL**.
  - ▢ Press **GROUND**, F1, [Go To Ground].
  - ▢ Wait for the display to show "Safe At Ground". It is now safe to disconnect the aircraft system or UUT.
- The pressure in the system changes towards ground. The ground pressure or "Ground" replaces the static or altitude aim value.
- If required, new rates of change can be entered while going to ground.
- To change the ROC or static rate, press **ROC/Ps Rate** and enter the new value.
- To change the airspeed or Qc rate, press **SPEED/Qc** then **RATE** and enter the new value.
- To change from going to ground, enter a new altitude (static) or airspeed (Qc) set-point.
- When the airspeed reaches zero and the Ps channel pressure nears ground, the system re-measures atmospheric pressure to update the recorded ground pressure (QFE). During this period, the display shows the message "**Checking Ground**". The ADTS 405 then reconnects to the aircraft system and equalises the system pressures. Commands cannot be entered when these two messages are displayed.
- The Ps channel pressure is then taken to the new recorded atmospheric pressure and, at this new pressure, the display shows the message "**Safe At Ground**". The ground vent and zero valves remain open to keep the aircraft system vented to atmosphere.
- Press **CLEAR/QUIT** to continue with normal operation. The ground vent and zero valves automatically close.

### 3.16 Options

#### WARNINGS:

1. **COMPLY WITH ALL LOCAL SAFETY ORDERS.**
2. **OBSERVE ALL SAFETY PROCEDURES IN THE AIRCRAFT MAINTENANCE MANUALS.**

#### SCPI IEEE 488 Option

The SCPI IEEE 488 interface provides remote control of the ADTS 405 from a suitable PC, using standardised commands.

The ADTS 405 implements the full SCPI command set with the exception of expressions and units suffixes. Although all the ADTS 405 commands at the first, or root, level are fully defined in the SCPI standard, many of the functions required have not been allowed for in the standard. The lower levels of commands have been created using the appropriate rules contained within the standard.

Druck publication K157 SCPI User Manual provides details of command codes, command syntax and examples of programming. Section 5 of this manual details a test procedure for the option.

#### Altimeter Encoder Option

The Altimeter Encoder Option allows the output from encoder altimeters to be displayed on either the hand terminal or display and key-pad of the unit. The displayed data includes the bit pattern and the equivalent altitude decoded from the bit pattern. The unit supplies 24 VDC to power the altimeter encoder electronics circuit and the altimeter vibrator circuit.

Druck publication K170 Altimeter Encoder Option User Manual provides details of displayed and encoded data. Section 5 of this manual details a test procedure for the option.

#### ARINC 429 Option

The ARINC 429 Interface provides the ADTS 405 with the ability to continuously transmit all internal aeronautical and pressure measurement parameters. Through an appropriate connector, the ADTS 405 can transmit the measurement parameters to the aircraft systems. The ADTS 405 can also monitor the aircraft ARINC 429 bus and display the measurement data on the hand terminal or the front panel display. The labels used for transmitting and receiving each parameter conform to the standard 429 specification.

Druck publication K185 ARINC 429 Option User Manual provides details of parameters and data output. Section 5 of this manual details a test procedure for the option.

### 3.17 SETUP and CONFIGuration

- The SETUP key provides access to secondary functions using a menu system, extends the keyboard and allows many of the ADTS 405 functions to be customised. All changes made under SETUP are temporary and will be lost when the system is switched off. The range of options allowed in set-up is determined by the set-up mode.
- Holding down the **F1** key while pressing **SETUP** provides access to the CONFIGuration mode. CONFIGuration is similar to SETUP with many identical functions. The changes made under CONFIGuration are permanent and remain set after the system is switched off. CONFIGuration can be used to change the power-up default settings of the ADTS 405 functions.

**Note:** Access to the CONFIGuration mode may be protected by a PIN.

### 3.18 Quick Reference

The quick reference charts show full set-up, minimum set-up and configuration functions. In the key/selection column the following applies:

ALT	-	Key.
[NEXT]	-	Item in menu (soft key).
(SINGLE DOUBLE)	-	Sequence of parameters selected by NEXT key.
(craft1 craft2...)	-	Sequence of names selected by NEXT key.
data entry	-	Enter number from key-pad.

The display shows the main pressure display (Leak Measure or Control mode).

#### Set-up example

Press SETUP and the display shows:

Pressing a function key (F1 to F4) enters the set-up menu.

When in set-up, pressing a key (ALT Ps in this example) enters a menu or setting that applies to the parameter.

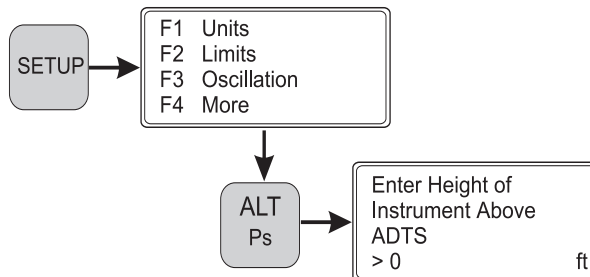

FULL SET-UP

Key/selection

Function and comments

SETUP	Full or minimum set-up selected in configuration.
[UNITS]	Select units
[NEXT]	Step through available units
[PREV]	Step back through available units
[SAVE]	Select displayed units
[LIMITS]	Select set of limits
[NEXT]	(aircraft 1\aircraft 2 ...)
[PREV]	As NEXT, in reverse order
[SEL]	Select displayed limit set
[OSC]	Oscillate about aim
[Ps]	For Ps channel
[START]	
[STOP]	
[FREEZE]	
[AMPL/FREQ]	
[AMPL]	Data Entry
[FREQ]	Data Entry
[Pt]	As for Ps channel
[MORE]	
[CONTROL]	
[Ps Pt DUAL]	Selects Ps only, Pt only or Dual channel control
[DISPLAYS/OPTIONS]	
[DISPLAY TYPE]	Select single, dual or triple display
[NEXT]	(SINGLE\DUAL\TRIPLE\ENCODER\ARINC429)
[PREV]	As NEXT, reverse order
[SAVE]	Save displayed Display Type
[OPTIONS]	See option manual
[CLOSE O/P VALVES]	Close output valves
[OPEN O/P VALVES]	Open output valves
[SYSTEM SELF TEST]	Start self test

SETUP + KEY PRESS

ALT	data entry	Altitude correction value
SPEED		Auto zero function
[AUTO ZERO]		
[ON]		
[OFF]		
[CAS/TAS]		Calibrated or true airspeed
[CAS]		
[TAS]		
[Pt TEMPERATURE]	data entry	Temperature for true airspeed
[Pt TEMPERATURE]		Enter Pitot temperature
MACH		Mach limit
[DEFAULT]		Defined by current limits
[OFF]		Removes Mach limit
[ON]		Enables Mach limit
[ON]	data entry	Enter new Mach limit

SETUP contd...

FULL SET-UP (contd.)

Key/selection

Function and comments

SETUP contd...	
RATE TIME	Set-up WAIT and TIME time periods
[WAIT/TIME ON F1]	For F1
[TIME]	Change to TIME
[WAIT]	Change to WAIT
data entry	of TIME time
data entry	of WAIT time
[WAIT TIME F2]	See [Wait/Time on F1]
[WAIT TIME F3]	See [Wait/Time on F1]
RATE	Automatic airspeed rate
[ON]	Automatic
[OFF]	Manual
LEAK MEASURE	
[AUTO LEAK]	Auto leak recovery on or off
[ON]	
[OFF]	
[AUTO LIMIT]	Auto limit recovery on or off
[ON]	
[OFF]	
GROUND	Airfield altitude for QNH display
data entry	
PORT	See Line Switching Unit User Manual
REMOTE	Remote mode lock, see configuration
PRINT	
[DATE/TIME]	Adjust date and time
[DATE]	Enter Date
data entry	
[TIME]	Enter Time
data entry	
HELP	Help on SETUP
▲ (Nudge UP)	Enter nudge values
[NEXT]	(ALT \ CAS / TAS \ MACH \ ROC \ RATE \ RATE CAS) Aeronautical units or
data entry	(Ps \ Pt \ Qc \ EPR \ RATE Ps \ RATE Qc \ RATE EPR) Pressure units
[PREV]	As NEXT, in reverse order
data entry	Required nudge increment
▼ (Nudge DOWN)	As Nudge UP

MINIMUM SET-UP

Key/selection

SETUP

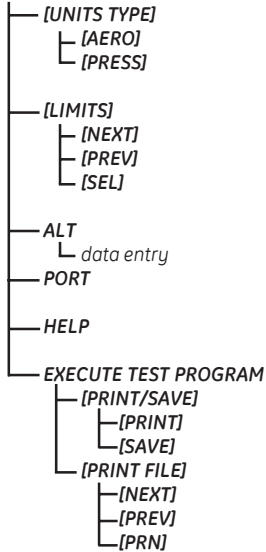

Function and comments

Full or minimum set-up selected in configuration.

Set units type

Set units to default aeronautical units

Set units to default pressure units

Select set of limits

(aircraft 1\aircraft 2 ...)

As NEXT, in reverse order

Select displayed limit set

Altitude correction value

See option user manual

Help on set-up

Result file related print option

Print/save mode selection

Print generated result data

Save generated result data to file

Print result file option

Select next result file

Select previous result file

Print selected result file

**CONFIGURATION**

**Key/selection**

**Function and comments**

**SETUP + F1**

[UNITS]	Hold F1 and press SETUP to enter CONFIG Default units
[AERONAUTICAL]	Select default aeronautical units
[NEXT]	Step through available units
[PREV]	Step back through available units
[SAVE]	Save selected units
[PRESSURE]	Select default pressure units
[NEXT]	Step through available units
[PREV]	Step back through available units
[SAVE]	Save selected units
[TEMPERATURE]	Select default temperature units
[C]	°C
[F]	°F
[LIMITS]	Configure sets of limits
[EDIT LIMITS]	Change limit values
[EDIT EXISTING]	Change existing values
[NEXT]	(aircraft 1 \ aircraft 2 ...)
[PREV]	As NEXT, in reverse order
[SEL]	Select aircraft to EDIT limits
[NEXT]	NAME \ MAX ALT \ MIN ALT \ MAX CAS \ MIN CAS \ MAX MACH \ MAX ROC \ MAX RATE CAS \ MIN Ps \ MAX Ps \ MIN Qc \ MAX Qc \ MAX RATE Ps \ MAX RATE Qc \ ARINC LIMITS \ ALTITUDE CORRECTION
[PREV]	As NEXT in reverse order
[ON/OFF]	Switch (toggle) to ARINC 565 limits
data entry	Limit value
[ALPHA]	Insert alphabet character in name
▲	Nudge up select next letter in alphabet
▼	Nudge down select previous letter in alphabet
[BACK]	Delete last character in name
[MAX LIMITS]	Create maximum limits called "MAX"
[EDIT NEW]	Create new limits
As for [EDIT EXISTING][SEL] above	
[CLEAR LIMITS]	Clear an existing set of limits
[NEXT]	(aircraft 1 \ aircraft 2 ...)
[PREV]	As NEXT, in reverse order
[SEL]	Clear selected limits
[YES]	Confirm delete
[NO]	
[LOCK AIRCRAFT]	Only DEFAULT limits available in USER mode SETUP can be used to select aircraft
[ON]	
[OFF]	
[DEFAULT AIRCRAFT]	(aircraft 1 \ aircraft 2 ...)
[NEXT]	As NEXT, in reverse order
[PREV]	
[SEL]	Select aircraft limits used at power-up. May be locked

SETUP + F1 contd...



Key/selection

Function and comments

CONFIG (SETUP + F1) contd...

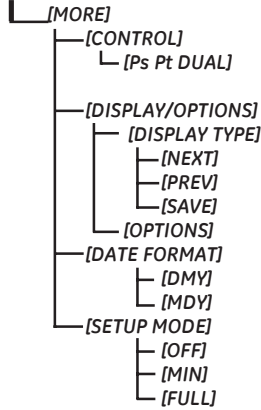

Ps Pt DUAL control  
 Ps single pipe testing of altimeters. Pt single pipe testing of airspeed and Mach indicators. DUAL normal combined system testing.

Configure display type  
 (SINGLE\DUAL\TRIPLE\ENCODER\ARINC429)  
 As NEXT, in reverse order  
 Save selection  
 See option manual  
 Format of date text  
 UK format DD/MM/YY  
 US format MM/DD/YY  
 Limits access to set-up functions

CONFIG (SETUP + F1) + KEY PRESS

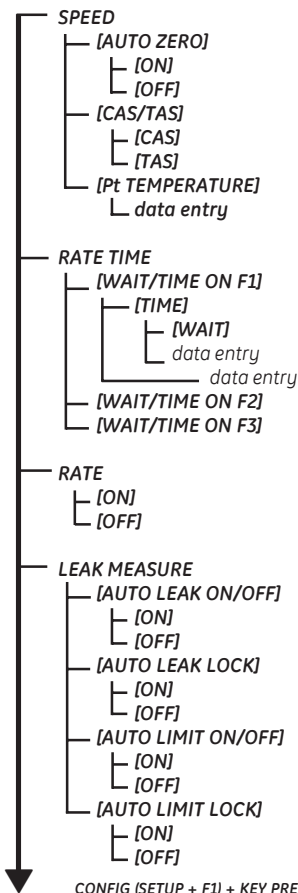

Auto zero function  
 Configure Calibrated or True airspeed  
 Configure Pt temperature  
 data entry

Configure WAIT and TIME times  
 For F1  
 Change to TIME  
 Change to WAIT  
 TIME time period  
 WAIT time period  
 See [Wait/Time on F1]  
 See [Wait/Time on F1]

Automatic airspeed rate  
 Automatic  
 Manual

Auto leak recovery Lock  
 Lock auto leak recovery Lock  
 Auto limit recovery state  
 Lock auto limit recovery state

CONFIG (SETUP + F1) + KEY PRESS contd...

Key/selection

Function and comments

CONFIG (SETUP + F1) + KEY PRESS contd...

<ul style="list-style-type: none"> <li>— GROUND                             <ul style="list-style-type: none"> <li>└─ data entry</li> </ul> </li> <li>— PORT</li> <li>— REMOTE                             <ul style="list-style-type: none"> <li>└─ [ON]</li> <li>└─ [OFF]</li> </ul> </li> <li>— ETP                             <ul style="list-style-type: none"> <li>— AUTO RUN                                     <ul style="list-style-type: none"> <li>└─ [NEXT]</li> <li>└─ [PREV]</li> <li>└─ [NONE]</li> <li>└─ [SEL]</li> </ul> </li> <li>— ERASE PROGRAMS                                     <ul style="list-style-type: none"> <li>└─ [NEXT]</li> <li>└─ [PREV]</li> <li>└─ [DEL]</li> </ul> </li> <li>— RESULTS                                     <ul style="list-style-type: none"> <li>└─ [PRINT/SAVE]   <ul style="list-style-type: none"> <li>└─ [PRINT]</li> <li>└─ [SAVE]</li> </ul> </li> <li>└─ [ERASE FILE]   <ul style="list-style-type: none"> <li>└─ [NEXT]</li> <li>└─ [PREV]</li> <li>└─ [DEL]</li> </ul> </li> </ul> </li> </ul> </li> <li>— ▲ (nudge up)                             <ul style="list-style-type: none"> <li>└─ [NEXT]</li> <li>└─ [PREV]</li> <li>└─ data entry</li> </ul> </li> <li>— ▼ (nudge down)</li> <li>— [000]                             <ul style="list-style-type: none"> <li>└─ data entry</li> </ul> </li> </ul>	<p>Airfield altitude for QNH display</p> <p>Refer to option user manual</p> <p>Remote mode lock</p> <p>Run test program on power up</p> <p>Refer to option user manual</p> <p>Delete test program</p> <p>Print/Save mode selection Generated result data printed Generated result data saved in a file Result file delete option Select next result file Select previous result file Delete selected result file</p> <p>[ALT\CAS\TAS\MACH\ROC\RATE CAS\Pt\Qc\EPR\RATE Ps\RATE Qc\RATE EPR] As NEXT, in reverse order Required nudge increment</p> <p>As nudge up</p> <p>PIN protection PIN (code number to enter CONFIG) set to 0000 for "no code required"</p>
---	---

## 4 Maintenance

### 4.1 Introduction

This section details the maintenance tasks to be carried out by the operator. The maintenance chart shows the maintenance tasks, the periodicity of each task and a code referenced to the task detailed in 4.3.

Task	Code	Period
Inspect	A	Daily, before use.
Inspect	B	Weekly
Test	C	Before use.
Test	D	Daily, before use.
Calibrate	E	Every 12 months *
Replace	F	As detailed in fault finding or when detailed after inspection.
Clean	G	Weekly *
Service	H	1,000 hours recorded by the pump unit elapsed time indicator or the equipment running log.
Service	J	3,000 hours recorded by the pump unit elapsed time indicator or the equipment running log.

\* Periodicity may change depending on usage and environment, refer to the Engineering Authority.

**TABLE 4-1 MAINTENANCE CHART**

## 4.2 Materials

This lists materials required for the user to maintain the ADTS 405. The item number and name in the table identifies the item in the maintenance tasks (for example, "Use a soft bristle brush, item 4, Table 4-2").

The description provides further information required to identify the item.

<b>Item Number</b>	<b>Item Name, Description</b>
1	Cloth, Cotton, Lint-Free
2	Alcohol, Isopropyl (MIL-A-10428, Grade A)
3	Detergent, Mild, Liquid
4	Brush, Soft-bristle (MIL-B-43871)

**Note:** *Equivalent substitutes can be used.*

**TABLE 4-2 MATERIALS LIST**

<b>(1) Ref Code</b>	<b>(2) Nomenclature</b>	<b>(3) Manufacturer's part number</b>
1	Voltmeter, Digital	Fluke series II, Type 77 H7291
2	Insulation Tester, 250V	Robin

**Note:** *Equivalent substitutes can be used.*

**TABLE 4-3 TOOL AND TEST EQUIPMENT REQUIREMENTS**

### 4.3 Maintenance Tasks

- A Visually inspect the unit for obvious signs of damage and check that all the equipment is present; record any deficiencies.
- B Visually inspect the pneumatic output connectors for damage. Inspect the small o-ring on each pneumatic output connector for cuts and any signs of wear; if necessary, replace as detailed in 4.4. Visually inspect pneumatic hoses, electrical cables for cuts, splits and damage; replace as necessary.
- C Before use, power-up the unit as detailed in Section 3. Check the date of the last calibration and, if necessary, refer to task E. Record any error messages and refer to Section 5.
- D Daily and before use, carry out the SST detailed in Section 5.
- E Normal calibration period 12 months. When calibration is due, the unit should be withdrawn from service and returned to depot or calibration facility. The date of calibration is stored in the unit and displayed in the power-up sequence and on a label on the front panel. Do not use a unit with out-of-date calibration. Engineering authority may change the periodicity of calibration depending on usage and the operating environment.
- F As detailed in fault finding or when detailed after inspection replace the listed item in table 2-1.
- G Clean the unit every week. Clean the front panel with a damp lint-free cloth (item 1, Table 4-2) and mild liquid detergent (item 3, Table 4-2). Remove any stubborn dirt using isopropyl alcohol (item 2, Table 4-2) and allow to dry. Clean all pneumatic connectors with a soft brush (item 4, Table 4-2). Remove any stubborn dirt using isopropyl alcohol (item 2, Table 4-2) and allow to dry.
- H Withdraw the unit from service and return to the repair depot. The intermediate service manual contains the 1,000 hour servicing procedure.
- J Withdraw the unit from service and return to the repair depot. The intermediate service manual contains the 3,000 hour servicing procedure.

## 4.4 Routine Maintenance

### WARNING:

**SWITCH OFF AND DISCONNECT THE POWER SUPPLY BEFORE STARTING ANY MAINTENANCE TASK.**

Carrying out the maintenance tasks detailed 4.3.

### Servicing Procedures

The following procedures provide instructions to test and replace items for the operator. Return the unit to the intermediate service depot for further testing and replacement of items.

Replacing the output connector o-ring

After inspection as detailed in maintenance task B, carry out the following if the o-ring is worn or damaged:

Carefully remove the o-ring from the small groove at the top of the connector.

Fit a new o-ring in the small groove at the top of the connector.

Make sure the o-ring is tight in the groove and not damaged after fitting.

**Note:** *Damage to this o-ring causes leaks.*

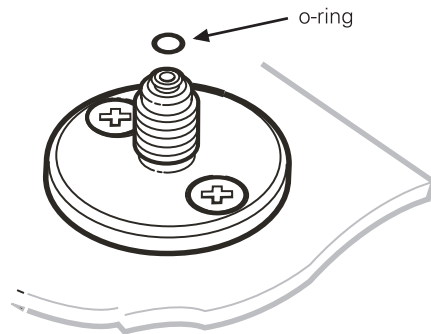

## Cable tests

Carry out the following check when detailed in Testing and Fault Finding, Section 5.

Measure continuity using the DVM (item 1, Table 4-3) set to an appropriate range.

Measure the continuity between corresponding pins at each end of each cable assembly. The measured resistance must not exceed 2.0 ohms.

**Note:** *This resistance value is the expected maximum value for the 18 metre (60ft) cable. The resistance value varies depending on the length of the cable.*

Measure insulation using the Insulation tester (item 2, Table 4-3), set to an appropriate range.

Measure the insulation resistance between the shell of the connector and all individual pins in turn.

Measure the insulation resistance between the shell of the appropriate connectors and all pins in turn.

Measure also the resistance between individual pairs of pins (i.e., 1-2, 1-3, 1-4, 1-5, 1-6, 2-3, 2-4, 2-5, 2-6, 3-4, 3-5, 3-6, 4-5, 4-6 and 5-6). In all cases the resistance must exceed 10 Mohms.

INTENTIONALLY LEFT BLANK



## 5 TESTING AND FAULT FINDING

### 5.1 Introduction

- The ADTS 405 contains a built-in, self-test and diagnostic system. The system continuously monitors the performance of the unit and at power-up carries out a self-test. Warning and error messages are displayed during normal operation if out of range values are entered or if faults occur.
- This section details the standard serviceability test and the possible error messages and codes that can be displayed. A fault diagnosis flow chart and table provide the probable cause and procedures to rectify specific symptoms.

#### Error messages

- When the display shows a message indicating entry of incorrect data or values, pressing QUIT clears the message and allows the correct entry to be made.

## 5.2 Standard Serviceability Test

- The following procedure can be used to check the functions and facilities of the ADTS 405. For further information refer to Section 6 - Reference and Specification.
- In the following:
  - ▢ All key presses are highlighted in **bold** and shown as identified on the key-pad.
  - ▢ Key presses inside brackets e.g., [MORE], are soft key presses (i.e., function key selections {F1 to F4} indicated on the display screen).

### Procedure

- Connection and power-on checks
  - ▢ Connect power to the unit and, if necessary, connect the hand terminal. Make sure that the blanking caps are fitted to the Ps and Pt front panel outputs. Check power indicator is on.
  - ▢ Set the front panel switch to OPERATE. Set the front panel switch for the pump unit to PUMP ON and check that the pump power indicator lights.
  - ▢ Check the display shows the first stage power-up message as below (where: x is the version number of the installed display driver software):

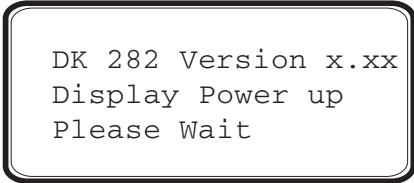

```
DK 282 Version x.xx  
Display Power up  
Please Wait
```

- ▢ Check the second stage power-up message displays as below (where: x is the version number of the installed main operating software):



```
DRUCK  
ADTS 405  
DK 263  
VER 6.xx
```

**Note:** "ADTS 405" may be replaced by an alternative identity string. The software version may also be supplemented by extra alpha characters.

- The ADTS 405 displays any detected errors. Check that the power-up sequence continues through the following stages without error:
  - Calibration date.
  - Self-test.
  - Measuring ground pressures.
  - Equalizing system pressures.
- Check that the display then changes to show measured altitude and airspeed (CAS or TAS) values.

#### NOTES

- 1 *The displayed values change as atmospheric pressure changes at power-up.*
  - 2 *The display shows the "WARMUP" message in the lower right corner indicating that full pressure accuracy and stability may not be achieved. The WARMUP message clears after 15 minutes. This indication does not inhibit operation and these tests may proceed without waiting for the message to clear.*
  - 3 *An automatic zero (if enabled) takes place regularly. The display shows "ZERO" and the state of the valves, on the mimic panel, change for approximately six seconds. Commands may still be entered while auto-zero takes place.*
- Press the **MACH** key and check the display changes to show Altitude and Mach measured values.

#### Pump unit

- Set the front panel switch for the pump unit to PUMP ON and check that the pump power indicator lights.
- Press **LEAK MEASURE/CONTROL** to go to control mode. Enter an altitude aim of 5000 ft by pressing **5, 0, 0, 0, ENTER**.
- Enter rate or use default rates.
- Enter an airspeed aim of 500 knots by pressing **SPEED, 5, 0, 0, ENTER**.
- Check that these aim values are achieved.

#### Completion

- On successful completion of this test procedure, select **GROUND**, [Go to Ground] wait until the unit is at ground, switch off and disconnect the power supply.

### 5.3 Self-Test Errors

- At power-up, the ADTS 405 indicates if there is a fault by displaying an error code for example:

701:HHHH PS SELF-TEST ERROR

- The HHHH is a hexadecimal code containing additional information record the whole error code.
- Paragraph 5.8 contains a table listing the error codes, check that the error code is complete and listed in the table before returning the unit to the repair depot.

### 5.4 Venting after Overpressure

- To calibrate or test the ADTS 405, an external pressure source is connected to the Ps and/or Pt output connectors. If, during calibration or test procedures, an overpressure occurs, the output valves close to protect the system. After the valves close pressure may be trapped in the internal system; the display may show on the next power-up error 701:0100 or 702:0100. The following procedure to vent this pressure enters the maintenance mode. Review and become familiar with the whole procedure before beginning the venting process:

1. Remove the source of pressure and vent Ps and Pt to atmosphere (caps off).

**CAUTION:** ONLY SELECT ITEMS DETAILED IN THE FOLLOWING MENUS, INCORRECT SELECTIONS CAN CAUSE CHANGES TO SAFETY LIMITS AND THE CALIBRATION DATA OF THE SYSTEM.

2. Re-power the ADTS 405. During the power-up screen:

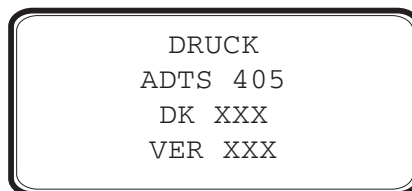

3. Press F1 and F4 simultaneously. The ADTS 405 enters the maintenance mode with the following screen displays.

**Note:** The system may prompt for a PIN. This is not the CONFIG PIN but the Calibration PIN. If this Calibration PIN is enabled and not entered, the system will not execute the following procedure.

**CAUTION:** ONLY SELECT ITEMS DETAILED IN THE FOLLOWING MENUS, INCORRECT SELECTIONS CAN CAUSE CHANGES TO SAFETY LIMITS AND THE CALIBRATION DATA OF THE SYSTEM.

4. The system enters the maintenance mode with the following screen display:

```
(MAINTENANCE)
F1  Data Block
F2  Supervisor EEPROM
F3  More
```

5. Select F3. The display shows:

```
(MAINTENANCE)
F1  System
F2  Hardware
F3  Error log
```

6. Select F3. The display shows:

```
(MAINTENANCE)
F1  Vent System
F2  Set System Ready
F3  View Temperature
```

7. Select F1 and when complete, press **CLEAR/QUIT** three times to reset the system.

## 5.5 Fault Diagnosis

- If the display shows a warning or error message, refer to the above sections.
- If a fault occurs, refer to the fault location chart, Figure 5-1 and Table 5-1 for possible fault causes and recommended action.

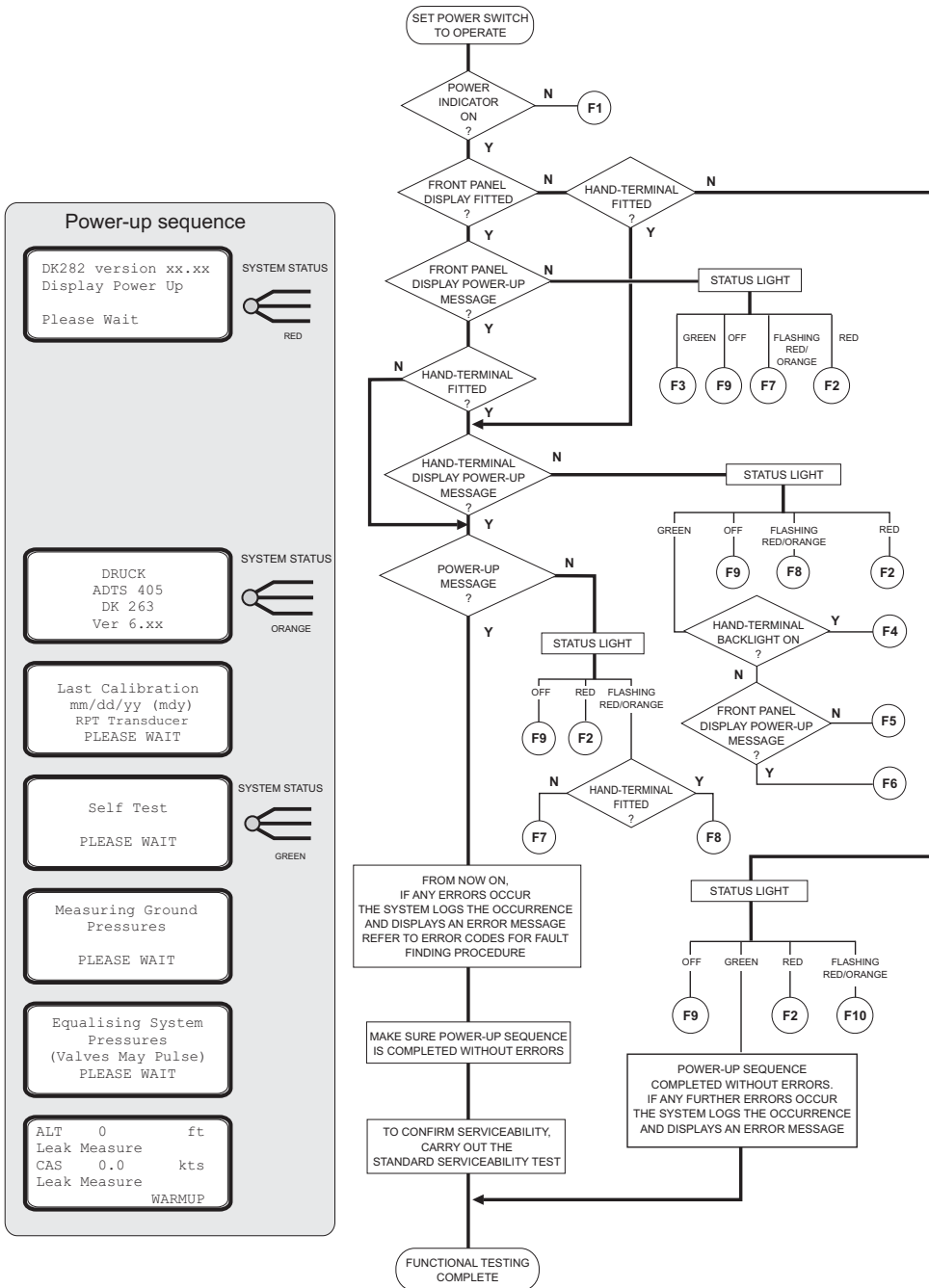

FIGURE 5-1 FAULT FINDING CHART

TABLE 5-1 FAULT FINDING

Fault	Symptom	Probable cause	Action
F1	Pump power-on indicator does not light.	Faulty power supply.  Unserviceable fuse, AC/DC power supply Faulty power supply cable.	Check power supply. Check/replace power supply fuse or reset circuit protection device. Check/replace fuse (front panel). Replace cable and re-test.
F2	AC or DC power indicator does not light.	AC or DC power supply cable to 405 rack. 405 rack AC input fuse. PSU fault.	Check/replace cables. Check/replace fuse. Record fault and return ADTS 405 to depot for repair.
F3	Display power-up message appears and status light remains red.	Internal control computer fault.	Record fault and return ADTS 405 to depot for repair.
F4	No front panel display power-up message, status light green.	Display fault.	Use an available hand-terminal. Record fault and return ADTS 405 to depot for repair.
F5	No hand-terminal display, status light green. Hand-terminal back- light on.	Hand-terminal fault (cable OK).	Replace hand-terminal. Record fault and return hand-terminal to depot for repair.
F6	No hand-terminal display, status light green. Hand-terminal back-light not on.	Hand-terminal.	Replace hand-terminal. Hand-terminal or hand-terminal cable fault. Record fault and return hand-terminal/cable to depot for repair.
F7	No front panel display DK127 message. Status light flashing red/orange.	No front panel display detected. Internal fault.	Record fault and return ADTS 405 to depot for repair.
F8	No hand-terminal or front panel display DK127 message. Status light flashing red/orange.	No hand-terminal or front panel display detected. Hand-terminal fault. Cable fault. Internal fault.	Remove hand-terminal and re-test.
F9	Status light off.	Internal PSU fault.	Record fault and return ADTS 405 to depot for repair.
F10	Status light steady orange.	System fault.	Record fault and return ADTS 405 to depot for repair.

## 5.6 Further Testing

- The following tests should only be carried out if a pneumatic leak or a controller instability is suspected.

### Test Environment and Preliminary Operations

- These tests should be carried out in a room with a stable temperature environment within the operating temperature range. The room must be free from drafts.
- Review and become familiar with the whole of the test procedure before beginning the test procedure.
- The unit must be thermally stable; switch on and leave the unit for at least one hour to achieve thermal stability.
- Change the units to mbar as follows:
  - (1) Press **SETUP** then select [UNITS]. Repeatedly select [NEXT] until the display shows "mbar".
  - (2) Select [SAVE] and then press **CLEAR/QUIT** twice and the display now shows Ps and Pt in units of mbar.

### Pressure Leak Check

- This section verifies that the unit is leak tight under positive pressure conditions.
  - (1) Press **LEAK MEASURE/CONTROL** to enter control mode. The display shows "Aim" in place of "Leak Measure".
  - (2) Enter a Ps aim of 1016 mbar by pressing: **ALT/Ps, 1, 0, 1, 6, ENTER**.
  - (3) Enter a Qc aim of 272 mbar by pressing: **SPEED/Qc, 2, 7, 2, ENTER**. Wait for the aim values to be achieved then wait for 1 min.
  - (4) Press **LEAK MEASURE/CONTROL** to return to Leak Measure mode.
  - (5) Press **RATE TIMER** and select [WAIT 05:00], [TIME 01:00]. Observe that the "Waiting" time is shown on the display as it counts down, followed by the "Timing" time.
  - (6) At the end of the "Timing" period, the display shows the rate of change of Ps, Qc and Pt with a "T" to indicate timed average.



- (7) Check that the Ps, Qc and Pt rates are less than or equal to  $\pm 0.5$  mbar/min. If the leak rate is not achieved, allow further thermal stabilization time and re-test by pressing **RATE TIMER** and selecting [WAIT 05:00], [TIME 01:00].
- (8) Press **CLEAR/QUIT** to exit rate display.

### Vacuum Leak Check

- o This section verifies that the unit is leak tight under vacuum conditions.
- (1) Press **LEAK MEASURE/CONTROL** to enter control mode. The display shows "Aim" in place of "Leak Measure".
  - (2) Enter a Ps aim of 100 mbar by pressing: **ALT/Ps, 1, 0, 0, ENTER**
  - (3) Enter a Qc aim of 0 mbar by pressing: **SPEED/Qc, 0, ENTER**
  - (4) Wait the required time for temperature stabilization e.g., one minute. Press **LEAK MEASURE/CONTROL** return to Leak Measure mode.
  - (5) Press **RATE TIMER** and select [WAIT 05:00], [TIME 01:00]. Observe that the "Waiting" time is shown on the display as it counts down, followed by the "Timing" time.
  - (6) At the end of the "Timing" period, press **ROC/Ps RATE** to display the measured rate of change of Ps ("T" is shown after the value indicating a timed average).
  - (7) Check that the Ps, Qc and Pt rates are less than or equal to  $\pm 0.5$  mbar/min. If the leak rate is not achieved, allow further thermal stabilization time and re-test by pressing **RATE TIMER** and selecting [WAIT 05:00], [TIME 01:00].
  - (8) Press **CLEAR/QUIT** to exit special rate time display.

### Range check

- o Using key presses based on the above, control the Ps and Qc pressures to the normal limits of operation and make sure that these are achieved. Use minimum Ps and zero Qc and then maximum Ps and maximum Qc.

**Note:** Do not exceed the maximum Pt as shown on the front panel of the unit. Use maximum available rates of change to minimise test times.

### Controller Stability

- This section verifies the control stability.
- (1) Press **LEAK MEASURE/CONTROL** to turn the pressure controllers on. "Aim" replaces "Leak Measure" on the display.
- (2) Enter a Ps aim of 510 mbar with a rate of change of 204 mbar/min. by pressing the following: **ALT/Ps, 5, 1, 0, ENTER, Ps RATE, 2, 0, 4, ENTER.**
- (3) Enter a Qc aim of 0 mbar with a rate of change of 204 mbar/min. by pressing the following: **SPEED/Qc, 0, ENTER, RATE, 2, 0, 4, ENTER.**
- (4) Press Ps and wait for the aim values to be achieved.
- (5) If auto-zero is enabled, wait for an auto-zero to take place. During auto zero, the valve state changes on the mimic panel and the display shows "Zero" in place of the airspeed aim value. The time to auto-zero should be less than 1 minute from achieving the aim value.
- (6) Wait for a minimum of 20 seconds after auto-zero before proceeding.
- (7) Observe the measured values of Ps and Qc on the display for 1 min.
- (8) Check that the displayed value of Ps remains within  $\pm 0.068$  mbar.
- (9) Check that the displayed value of Qc remains within  $\pm 0.068$  mbar.

**Note:** *If a further auto zero takes place, allow the display to stabilize following the auto zero before proceeding.*

## 5.7 Testing an Option Facility

- The following tests should only be carried out if the serviceability of an option facility is suspected or when an error occurs.

### Testing the IEEE 488 Facility

- This IEEE 488 facility requires specialist knowledge of both IEEE 488 communications and test programming for specified, authorized test procedures. Only qualified personnel should use this facility, the test procedure must be authorized by the appropriate engineering authority.
- To enable and disable this IEEE 488 facility access the configuration menu. When enabled, this facility will be available from power-up of the ADTS 405 with the settings held in non-volatile memory.

### Configuring and Enabling the IEEE 488 Facility

- To enable the IEEE 488, set the ADTS 405 to the SCPI IEEE option and set to Address 1 as follows:
  - ▢ Press and hold down **F1** then press **SETUP** to enter the configuration menu. Release both keys.
  - ▢ If requested, enter PIN details.
  - ▢ Press [MORE], [DISPLAY/OPTIONS], [OPTIONS], [IEEE-488], [SCPI/OPT2].
  - ▢ Check the display shows that SCPI is selected, if the settings are correct, press **CLEAR/QUIT** until the display shows the main pressure display, run the test program below.
- If the display does not show that SCPI is selected, press [SCPI].
  - ▢ Press **CLEAR/QUIT**, [DEVICE ADDRESS].
  - ▢ Check the address displayed is 1.
  - ▢ If not, press 1 on the numeric key-pad and then **ENTER**.
  - ▢ If any changes have been made, press **CLEAR/QUIT** until requested to accept the changes, then press **ENTER**.
  - ▢ The ADTS 405 automatically restarts, when the display shows the main pressure display, carry out the following test program.

### Programming a Test of the IEEE 488 Facility

- There are many different programs and items of equipment for communicating over the IEEE 488 interface. In the following example, the user must be familiar with the IEEE 488 bus controller to be used.
- The following example commands can be used to check for correct operation of the IEEE 488 interface.  
Initialize the bus controller as follows:
  - Set Address 1 as the talker listener address.
  - Make sure that bus time-out periods are set sufficiently high (e.g., 5 seconds).
  - Set the bus controller to send EOI with last byte and to expect EOI on last byte of received data.
  - Send interface clear (IEEE 488 command).
  - Send "SOURCE:STATE OFF" (one space between STATE and OFF).
  - Send "SOURCE:STATE?"
  - Instruct device 1 to TALK and input the response string.
  - The response string should be "OFF".
  - (1) If the above procedure is unsuccessful, check the continuity of the IEEE 488 cable.
  - (2) If faulty, replace the cable.
  - (3) If the continuity of the cable is correct, return the ADTS 405 to the repair depot.

**Connection of the IEEE 488 Facility**

- o The front connector is behind the option connector cover plate.

**CAUTION:** THE OPTION CONNECTOR COVER MUST ALWAYS BE FITTED WHEN THE EQUIPMENT IS USED OUTDOORS OR IN AN ENVIRONMENT WHERE MOISTURE MAY ENTER THE UNIT THROUGH THE OPTION CONNECTOR PANEL.

- o The connector details are as follows:

Standard Connector Pin Number	Function	Standard Connector Pin Number	Function
1	DI01	13	D105
2	D102	14	D106
3	D103	15	D107
4	D104	16	D108
5	E0I	17	REN
6	DAV	18	Gnd [2]
7	NRFD	19	Gnd [2]
8	NDAC	20	Gnd [2]
9	IFC	21	Gnd [2]
10	SRQ	22	Gnd [2]
11	ATN	23	Gnd [2]
12	Shield [1]	24	Gnd [2]

[1] Chassis connection  
 [2] 0V return for signals (not chassis)

## Testing the Altimeter Encoder Option

- To enable and disable this Altimeter Encoder facility access the configuration menu. When enabled, this facility will be available from power-up of the ADTS 405 with the settings held in non-volatile memory.

## Configuring and enabling the Altimeter Encoder Option

- - ▢ Press and hold down **F1** and press **SETUP** to enter the configuration menu. Release both keys.
  - ▢ Press [MORE], [DISPLAY/OPTIONS], [DISPLAY TYPE], [NEXT], [ENCODER].
  - ▢ Check the display shows "Encoder" is selected.
  - ▢ Press [SAVE], then repeatedly press **CLEAR/QUIT** until the display shows the following:

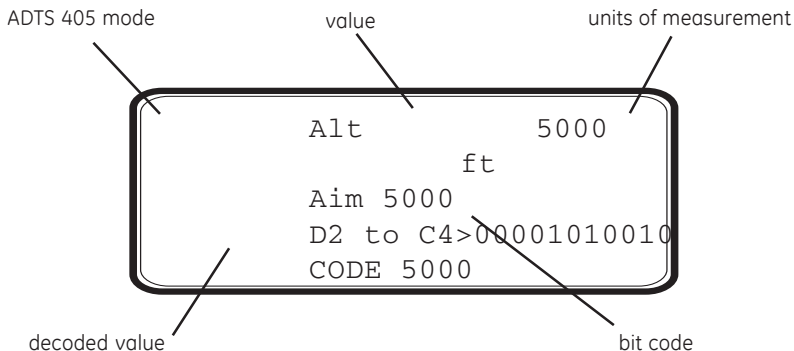

**Note:** With an incorrect bit combination such as all zeroes, the display shows "ENCODER ERROR" in the place of the decoded value.

- If the above procedure is unsuccessful, check the continuity of the Altimeter Encoder cable.
- If faulty, replace the cable.
- If the continuity of the cable is correct, return the ADTS 405 to the repair depot.

Optional cable (AAU-32 units)

- The 15-core cable is supplied for the AAU-32 encoder unit:

**Note:** The D2 data line (turquoise cable) is not defined for the AAU-32, it is for above 62,000 ft and not connected.

Front panel connector pin No.	Function	Cable colour code	AAU-32 connector pins
1	C4 LSB	brown	B
3	C2	red	C
5	C1	orange	D
7	B4	yellow	E
9	B2	green	F
11	B1	blue	G
13	A4	violet	H
22	A2	white	J
2	A1	grey	K
4	D4	black	L
n/c	D2 MSB	torquoise*	n/c
8	common (0V) signal	pink	A
10	common (0V) power	yellow/red	<u>b</u> +M
14	+24 V vibrator	red/blue	P
12	+24 V encoder	green/red	<u>c</u>
shell	case/ground	shell	<u>a</u> + shell

OPTIONAL CABLE CONNECTIONS

## Testing the ARINC 429 Option

- To enable and disable this ARINC facility access the configuration menu. When enabled, this facility will be available from power-up of the ADTS 405 with the settings held in non-volatile memory.

### Configuring and enabling the ARINC 429 Option

- To enable the ARINC option as follows:
  - Press and hold down **F1** and press **SETUP** to enter the configuration menu. Release both keys.
  - Press [MORE], [DISPLAY/OPTIONS], [OPTIONS], [ARINC-429].
  - Check the display shows ARINC 429 is selected.

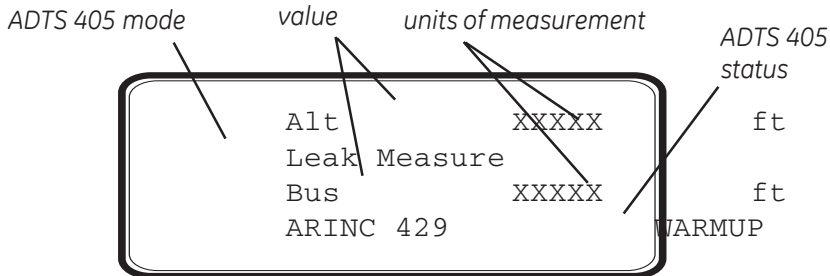

**Note:** If the ARINC 429 option is not fitted the value is replaced by "absent".

- If the above procedure is unsuccessful, check the continuity of the ARINC 429 cable.
- If faulty, replace the cable.
- If the continuity of the cable is correct, return the ADTS 405 to the repair depot.

Function	Pin	Colour
output +ve	15	yellow
output -ve	16	blue
input +ve	18	green
input -ve	19	red
Ground/earth	shell	-



## 5.8 Fault Finding

### 5.8.1 Error Messages

- o In the event of a malfunction, the built-in, self-test and diagnostic system displays an error message and error code. A unit displaying this type of error should be returned to the repair depot:

TABLE 5-2 ERROR MESSAGES

Error Code	Error Message	Hexadecimal Code
515	PSU NO LONGER READY	
516	UNKNOWN CONTROLLER ERROR	
517	RING TIME OUT	
550	Ps HUMIDITY SENSOR FAILURE	
551	Pt HUMIDITY SENSOR FAILURE	
601	INTERNAL RAM ERROR	
603	ERROR WRITING TO EEPROM	
603	SYSTEM EEPROMS FAULTY OR NOT FITTED	
701	Ps SELF-TEST ERROR	✓
702	Pt SELF-TEST ERROR	✓
703	Ps SELF-TEST TIME OUT ERROR	
704	Pt SELF-TEST TIME OUT ERROR	
710	Ps CONTROLLER ERROR	✓
711	Ps CONTROLLER ERROR	✓
712	Ps CONTROLLER ERROR	✓
713	Ps CONTROLLER ERROR	✓
714	Ps CONTROLLER ERROR	✓
717	Ps CONTROLLER ERROR	✓
720	Pt CONTROLLER ERROR	✓
721	Pt CONTROLLER ERROR	✓
722	Pt CONTROLLER ERROR	✓
723	Pt CONTROLLER ERROR	✓
724	Pt CONTROLLER ERROR	✓
727	Pt CONTROLLER ERROR	✓
801	IEEE488 DRIVER FAILED TO OPEN	
802	IEEE488 DRIVER FAILED TO RESET	
900	INTERNAL SOFTWARE	
999	INTERNAL ERROR	

**Note:**  
Some errors display extra information using a four digit hexadecimal code. This should always be recorded with the error number to provide information for the repair depot.

**IMPORTANT NOTE**  
If the display shows **ERROR 703 START UP Ps SELF TEST TIME ERROR.** Check that the expansion port plug (item 13, Table 2-1) is correctly connected in the expansion port on the rear panel (Fig. 2-4).

### 5.8.2 Warning Messages

- The following table lists the warning messages with the probable cause and action to be taken.

**TABLE 5-3 WARNING MESSAGES**

No.	Message	Probable Cause	Action
2	INVALID USER INPUT	The numeric value entered was outside the allowed range	Re-enter value within allowed range
3	OPERATE CAL ENABLE ON STATUS PANEL	Calibration started before removing calibration enable plate on the front panel	Refer to the main fault finding chart in the service manual
4	ONLY VALID IN CONTROL MODE	Selection not allowed in Leak measure mode	Select controller on
210	Ps SOFT START TIMEOUT	The Ps controller has failed to go into control mode	Select CONTROL again. If fails again, refer to the main fault finding chart in the service manual
212	Ps PRESSURE FAIL	The Ps controller has detected loss of supply pressure and automatically switched all channels to measure mode. This can occur at very high rates of pressure change in large volume systems if the pumps cannot produce enough pressure	Restore pressure supply BEFORE going to control mode again. Refer to the main fault finding chart in the service manual
213	Ps VACUUM FAIL	The Ps controller has detected loss of supply vacuum and automatically switched all channels to measure mode. this can occur at very high rates of pressure change in large volume systems if the pumps cannot produce enough vacuum	Restore vacuum supply BEFORE going to control mode again. Refer to the main fault finding chart in the service manual
220	Pt SOFT START TIMEOUT	The Pt controller has failed to go into control mode	Select CONTROL AGAIN. If fails again, refer to the main fault finding chart in the service manual
222	Pt PRESSURE FAIL	The Pt controller has detected loss of supply pressure and automatically switched all channels to measure mode. This can occur at very high rates of pressure change in large volume systems if the pumps cannot produce enough pressure	Restore pressure supply BEFORE going to control mode again. Refer to the main fault finding chart in the service manual

*(continued)*

TABLE 5-3 WARNING MESSAGES (CONTINUED)

No.	Message	Probable Cause	Action
223	Pt VACUUM FAIL	The Pt controller has detected loss of supply vacuum and automatically switched all channels to measure mode. This can occur at very high rates of pressure change in large volume systems if the pumps cannot produce enough vacuum	Restore vacuum supply BEFORE going to control mode again.
301	LEAK RATE TOO HIGH REGAINING CONTROL	Control mode automatically regained for aircraft safety as leak rates too high	Correct leak and retest
302	OUTSIDE LIMITS REGAINING CONTROL	Control mode automatically regained for aircraft safety as the measured values have drifted outside of the operating limits due to leaks	Correct leaks and retest. If leak Ps, ensure that nominal Qc pressure is applied (e.g. 200 kts to avoid negative airspeed)
303	ZERO OFFSET TOO LARGE	The zero offset measured during auto-zero was outside	Return to maintenance depot for calibration
304	INITIALIZING BLANK SYSTEM EEPROMS	This only occurs if new EEPROMS have been fitted or on main system software upgrade	If message occurs during normal operation, return to maintenance depot.
305	OUTSIDE LIMITS GO TO GROUND	Measured pressure is outside new limits selected or power-up limits	Control pressures to within limits
306	SWITCH PUMPS ON	Cannot select control mode with the pumps off	Switch pumps on
307	COMMUNICATION RING FAULT - PACKET IS CORRUPT	Internal error	If the fault can be repeated, return to maintenance depot.
308	UPDATING SYSTEM EEPROMS	Software upgrade	Wait 1 minute
309	CANNOT CONTROL	Failed pump test	Check system limits
310	PUMP TEST FAILED	Pump not achieving limits	Set lower limits

INTENTIONALLY LEFT BLANK

## 6 REFERENCE AND SPECIFICATION

### 6.1 Introduction

- This section includes a full description of each key function including references to associated functions.
- The available keys are:
  - F1 - F4
  - ALT/Ps
  - SPEED/Qc
  - MACH/Pt
  - EPR
  - ROC/Ps RATE
  - RATE TIMER
  - HOLD
  - RATE
  - LEAK MEASURE/CONTROL
  - GROUND
  - PORT
  - REMOTE
  - PRINT
  - EXECUTE TEST PROGRAM
  - HELP
  - SETUP
  - s (nudge up)
  - t (nudge down)
  - 0 to 9
  - 000
  - CLEAR/QUIT
  - ENTER
  - . (decimal point)

Double key presses give:

ABORT (CLEAR + ENTER)  
CONFIGURATION (F1 + SETUP)

### 6.2 Main Pressure Display

#### F1 - F4

- These function keys or soft-keys are used to select choices from menus. The menu choices may be shown directly over the keys or displayed as a list.
- When a menu is displayed, press the appropriate function key to select the required choice.
- **CLEAR /QUIT** can be used to leave a menu without making a selection.

### ALT/Ps

- In aeronautical units (ft or m), this key selects an altitude display.
- In pressure units (mbar, inHg etc.), this key selects a static pressure (Ps) display.
- **SETUP**, [UNITS] can be used to change the units of display, if set-up mode is not switched off.
- Before entering a new altitude or Ps aim, set the rate of change using the **ROC/Ps Rate** key.
- In Control Mode (Aim display), enter a new altitude or Ps aim using the numeric keys. Use **LEAK MEASURE/CONTROL** to change between Control and Leak Measure mode.

### SPEED/Qc

- In aeronautical units (kts, km/h), this key selects an airspeed (CAS or TAS) display. In pressure units (mbar, inHg etc.), this key selects dynamic pressure and the display shows (Qc).
- The airspeed can be displayed and entered as either Calibrated Airspeed (CAS, Vc) or True Airspeed (TAS, Vt).  
**Note:** *For testing purposes, Calibrated Airspeed equates to Indicated Airspeed (IAS).*
- The Pt temperature value affects the calculation of TAS. The value of Pt temperature, normally measured by the aircraft temperature sensor, can be changed by **SETUP**, **SPEED/Qc**, [Pt TEMPERATURE] only in full set-up mode.
- Use **SETUP**, **SPEED/Qc**, [CAS/TAS] to select CAS or TAS.
- CAS/TAS can be changed in full set-up mode.
- If the altitude aim is changed, after the entry of CAS, the Mach and TAS aim values change while the CAS value remains unchanged\*.
- If the altitude aim is changed, after the entry of TAS or Mach, the CAS aim value changes while the TAS and Mach values remain unchanged\*.
- If the Ps aim is changed, after the entry of Qc, then the Pt aim value changes while the Qc remains unchanged\*.

- If the Ps aim is changed, after the entry of Pt, then the Qc aim value changes while the Pt remains unchanged\*.  
*\* The display shows = symbol next to the parameter that remains unchanged.*
- **SETUP**, [UNITS] can be used to change the units of display, if set-up mode is not switched off.
- Before entering a new CAS or Qc aim, the rate of change should be set using the **RATE** key.
- In Control Mode (AIM display), a new CAS or Qc can be entered using the numeric keys. Use **LEAK MEASURE/CONTROL** to change between Control and Leak Measure mode.

### MACH/Pt

- In aeronautical units (ft/kts or m/km/h), this key selects a Mach display.
- In pressure units (mbar, inHg etc.), this selects a total pressure (Pt) display.
- If the altitude aim is changed, after the entry of CAS, the Mach and TAS aim values change while the CAS value remains unchanged\*.
- If the altitude aim is changed, after the entry of TAS or Mach, the CAS aim value changes while the TAS and Mach values remain unchanged\*.
- If the Ps aim is changed, after the entry of Qc, then the Pt aim value changes while the Qc remains unchanged\*.
- If the Ps aim is changed, after the entry of Pt, then the Qc aim value changes while the Pt remains unchanged\*.  
*\* The display shows = symbol next to the parameter that remains unchanged.*
- Before entering a new Mach or Pt aim, set the rate of change of speed using the **SPEED/Qc** key followed by the **RATE** key.
- In Control Mode (AIM display), a new Mach or Pt aim can be entered using the numeric keys, Use **LEAK MEASURE/CONTROL** to change between Control and Leak Measure mode.

### EPR

- Engine Pressure Ratio (EPR) is only available in pressure units (mbar, inHg etc.).
- The ADTS 405 can be used to check EPR sensors and indicators.
- For EPR testing, use Ps as INLET pressure and EPR to set the ratio of OUTLET pressure (Pt) to INLET pressure.
- Before entering a new EPR aim, the rate of change should be set using the **RATE** key.
- In Control Mode (Aim display), a new EPR aim can be entered using the numeric keys. Use **LEAK MEASURE/CONTROL** to change between Control and Leak Measure mode.

### ROC/Ps RATE

- In aeronautical units (ft or m), this key selects a Rate of Climb (ROC) or vertical speed display.
- In pressure units (mbar, inHg etc.), this key selects a rate of change of Ps display.
- **SETUP**, [UNITS] can be used to change the units, if set-up mode is not switched off.
- In Control Mode (AIM display), a new ROC or Ps rate can be entered using the numeric keys. Use **LEAK MEASURE/CONTROL** to change between Control and Leak Measure mode.

### RATE TIMER

- The **RATE TIMER** key starts an internal timer for one of three pre-defined times. On the completion of the time period, the average rate of change over the time period is displayed.
- Each selected TIME period can have an associated WAIT period to allow pressures to settle before the timing starts. The WAIT period counts down to zero before the TIME period starts.
- To use the rate timer:
- Press **RATE TIMER**.



- ▣ Press F1, F2 or F3 to select the required WAIT and TIME periods.
- ▣ The main pressure displays shows the WAIT or TIME period counting down.
- ▣ After timing, the timed average value, identified by a **T** directly to the right of the value, replaces the instantaneous rate value.
- ▣ In measure mode the display changes to show the timed rate of all associated parameters on the same screen. Pressing one of the set-point keys (e.g., ALT, ROC, SPEED etc.) or **CLEAR/QUIT** exits from this screen.
- ▣ At any time during rate timing or when a timed value is displayed, pressing the **RATE TIMER** key allows for either the restarting or cancelling of the timing. When timing is cancelled, the rate displays return to instantaneous values.
- ▣ The timed average value remains until a new aim is entered. During this time, it is possible to view any parameter.
- ▣ The WAIT and TIME periods can be changed using **SETUP, RATE TIMER**, providing SETUP lock is not enabled.

## HOLD

- ▣ When **HOLD** is pressed, a changing pressure is instantaneously held. Pressing **HOLD** again releases the pressure to continue to the aim value. The **HOLD** facility applies to both channels simultaneously and can be used to test pressure switches as follows:

### Airspeed Switch Test

- ▣ Take the airspeed to a value just below the expected trip point.
- ▣ Enter a low rate of speed.
- ▣ Enter a new airspeed aim above the trip point.
- ▣ Immediately the switch trips, press **HOLD**.
- ▣ Read the airspeed value - this is the trip value for increasing airspeed.
- ▣ Enter a new airspeed aim below the expected trip value.
- ▣ Immediately the switch trips, press **HOLD**.
- ▣ Read the airspeed value - this is the trip value for decreasing airspeed.
- ▣ Press **HOLD** again to release hold.
- ▣ For both channels to start moving to new aims at the same time, use the following sequence:
  - ▣ Press **HOLD**.
  - ▣ Enter Ps channel aim.
  - ▣ Enter Pt channel aim.
  - ▣ Enter required rates.
  - ▣ Press **HOLD** again to release hold.
  - ▣ **HOLD** is automatically released when entering Measure Mode.

**RATE**

- In aeronautical units (kts, km/h), this key selects a rate of change of airspeed (Rate CAS) display.
- In pressure units (mbar, inHg etc.), this key selects a rate of change of pressure (Rate Qc, Rate Pt or Rate EPR) display. The actual display depends on the parameter selected before pressing **RATE**.
- The following rates are available in aeronautical units:

Key-press sequence	Rate of change display
SPEED, RATE	Rate CAS *
MACH, RATE	Rate MACH

\* Rate CAS is displayed with the airspeed in either CAS or TAS.

- The following rates are available in pressure units:

Key-press sequence	Rate of change display
Qc, RATE	Rate Qc
Pt, RATE	Rate Pt
EPR, RATE	Rate EPR

- If set-up mode is not switched off, **SETUP**, [UNITS] can be used to change the units of display.
- A new rate aim can be entered using the numeric keys, if the unit is in Control Mode (Aim displayed). Use **LEAK MEASURE/CONTROL** to change between Control and Leak Measure mode.
- If the automatic airspeed rate is selected (using **SETUP, RATE**) the airspeed rate is automatically adjusted to simultaneously achieve both altitude and airspeed aim values. This adjustment normally requires a reduction in the rate from the aim value; the rate does not exceed the aim value. When airspeed (not Qc) is automatically reduced, the display shows **(A)** after RATE CAS.

**LEAK MEASURE/CONTROL**

- This key switches between Control and Leak Measure mode.

**Note:** The pneumatic supply pumps must be switched on before going to CONTROL mode.

- The controllers can be switched off to measure leaks in the aircraft system.
- When in leak measure mode, the display shows **"LEAK MEASURE"**.
- Press **LEAK MEASURE/CONTROL** to switch the controllers on. The display briefly shows **"REGAINING CONTROL"** while the pressure controllers adjust to the system pressure. No significant pressure transients are produced when regaining control.
- When in control mode, the display shows **"Aim"** value.
- Two safety systems are built-in to protect the aircraft systems during leak testing. These are Auto Leak recovery and Auto Limit recovery.
- Auto Leak recovery automatically regains control if the leak rate exceeds the currently set limits on either channel.
- Auto Leak recovery can be switched off using **SETUP, LEAK MEASURE/CONTROL, [AUTO LEAK]**.
- If negative airspeed or Qc occurs in measure mode, the zero valve automatically opens for a period of one second to balance the airspeed or Qc. This only applies when the minimum CAS (or Qc) limit is zero.

**Note:** *This only applies when the minimum CAS or Qc limit is zero.*

- Auto Limit recovery automatically regains control if the pressure on either channel leaks outside of the selected limits, (except for negative airspeeds).
- Auto Limit recovery can be switched off using **SETUP, LEAK MEASURE/CONTROL, [AUTO LIMIT]**.

**Note:** *Auto Limit and Auto Leak recovery functions require the pneumatic supply pump to be switched on.*

## GROUND

- This key enables a display of ground pressure or automatically controls the pressures in the aircraft system to local atmospheric pressure.
- The local atmospheric pressure is recorded by the ADTS 405 during the power-up sequence.

- When **GROUND** is pressed, a menu gives a choice of three ground functions:

### [GO TO GROUND]

**Note:** *The Go-to-Ground operates only in Control Mode.*

- Selecting [GO TO GROUND] automatically enters an altitude or static aim equivalent to local atmospheric pressure (QFE) and an airspeed or dynamic pressure aim of zero. The system pressures will then be controlled towards these aims, in the normal way, at the rates set by the **ROC/Ps Rate** and **RATE** keys. At any time when going-to-ground, a new rate of change can be entered, the ADTS 405 continues going-to-ground.
- At any time during going-to-ground, a new value aim for ALT, CAS, TAS, Mach, Ps, Qc, Pt or EPR can be entered. This causes the procedure to stop and normal controlling operation to start.
- When the airspeed is zero and the Ps channel pressure is close to ground, the QFE is re-measured to update the stored "ground" pressure value, the display shows the message "**CHECKING GROUND**". The ADTS 405 then reconnects to the system under test and equalizes the pressures.
- The display shows the message "**Safe At Ground**"; the ground and zero valves remain open so that the aircraft system permanently vents to atmosphere. No commands can be entered when these two messages are displayed.
- Press **CLEAR/QUIT** to continue with normal operation. The ground and zero valves then automatically close.

### [DISPLAY QFE]

- When [DISPLAY QFE] is selected, the local atmospheric pressure recorded during the power-up sequence is displayed as QFE in the default units set in configuration.
- Press **CLEAR/QUIT** to return to the normal user display.

### [DISPLAY QNH]

- When [DISPLAY QNH] is selected, the local atmospheric pressure recorded during power-up is converted to the equivalent sea level pressure. The display shows QNH, in the default units set in configuration, together with the station (airfield) altitude.
- The station (airfield) altitude can be changed in full set-up mode by using **SETUP, GROUND**.

## PORT

- This function sets the port option, this changes the ADTS 405 from a single pitot-static output system to a multi-port system by using a Druck Line Switching Unit (LSU 100 and 200 Series). Refer to the option manual.

## REMOTE

- Enters Remote Mode; this mode allows an external device to control the unit. In this mode the key-pad (except the Remote key) is disabled. If remote lock is disabled, pressing the remote key when the "**REMOTE**" message is not displayed forces the unit into remote mode as if the external device has taken control of the unit.

**Note:** *This may change operator settings such as the current limit set.*

Refer to the option user manual for further details.

## PRINT

- The ADTS 405 contains a print facility to print the displayed readings together with up to nine user readings (e.g., Pilot, Copilot, Aux).
- This facility requires a Centronics standard parallel interface printer of 80 or 132 column width.
- This key causes a printout of the date and time followed by the measured value of the parameters. A prompt asks for the entry of a reading which can consist of any characters **A** to **Z**, **0** to **9**, **.** (decimal point) or **-** (minus), in any order. It can be used to enter the value from the unit or system under test or alternatively a test number. When no more entries are required, press **CLEAR/QUIT**.
- To enter an alphabetic character (A to Z), press the [ALPHA] key and use the *s* or *t* (nudge keys) to change to the required character. To enter another alphabetic character, press the [ALPHA] key again. Press [BACK] to delete the last character.
- Up to nine user readings can be entered sequentially. The display prompts for the next user reading each time one is entered. When no further readings are required, press **CLEAR/QUIT**.

### Example print output:

```
04Mar00 09:47 Ps 700.00 mbar Qc 30.00 mbar Usr Rdg
```

## EXECUTE TEST PROGRAM

The Test Program Manager (option D) enables the ADTS 405 to use prepared test procedures or sequences to meet aircraft and component testing requirements. Using this PC-based application, a test procedure can be programmed and then down-loaded to the ADTS 405. Once down-loaded, the ADTS 405 stores the program for future use. A test program can contain operator prompts to enter numeric values from instruments; test results can be stored in the ADTS 405 and later printed, by a suitable printer, through the serial output port.

A test simulator in the TPM option gives the operator a method of developing a test program. The new test can be verified, on the PC, at up to fifty times normal speed to reduce test time.

### EXECUTING TEST PROGRAMS (without auto run)

1. Press the **EXECUTE TEST PROGRAM** key. This displays the first of the available test programs. The top line shows the file name and the second and third lines show the TITLE.
2. Use [NEXT] or [PREV] to step through the available programs until the required program is displayed. Press [RUN] to select the program.
3. The display shows a menu allowing the following selections:

[F1] Run all tests.	This starts the program from the beginning.
[F2] Run specific tests.	This allows execution to start with any one of the individual TESTS contained within the test program. Use [NEXT], [PREV] and [SEL] as above.
4. Select [Run all tests]  
The display returns to the normal user display.  
"TP", in the bottom right hand corner of the display, indicates execution of a test program.
5. Various commands prompts the operator by displaying messages on screen such as:  
"Press the ETP key".  
  
The ETP key is the general key for moving onto the next step. The **CLEAR/QUIT** key should only be used to terminate test program execution.
6. At the end of each test, the operator has a choice of continuing, exiting test program execution or going to manual mode.

7. In manual mode, any of the normal key-pad functions may be used. When the manual testing is complete, press **EXECUTE TEST PROGRAM** and the test program continues from where it left off. This feature may be disabled by including the KEYLOCK command in the test program. While in manual mode the display prompts **"TPM"**.
8. When a "go" command is executed, **"GO"** flashes in the lower right hand corner of the screen. At this point the user should record any instrument readings or displayed leak rates, as required, before continuing by pressing EXECUTE TEST PROGRAM. F4 may be used to continue at a "go" command as an alternative to pressing **EXECUTE TEST PROGRAM**.

### Deleting files

If a test program within an ADTS 405 is no-longer required, then it may be deleted. To delete a test program, proceed as follows:

1. Enter configuration (CONFIG) by pressing and holding **F1** and pressing **SETUP**.
2. At the first menu level of configuration, press the **EXECUTE TEST PROGRAM** key, then F2. The display then shows the file name and title of the first file in the list. Use [NEXT] and [PREV] to step through the files until the display shows the file to be deleted.
3. Select [DEL] to delete the file, then press **CLEAR/QUIT** to quit from configuration.
4. Select [YES] to confirm quit.

**Note:** *If the deleted program is marked as "AUTO RUN" then an additional screen asks to confirm if the auto run status should be removed before deletion.*

### Auto Running a Program

To run a program each time the ADTS 405 is switched on, the "Auto run" feature should be enabled. The enabled program starts, from the first line, after successful completion of the ADTS power-up sequence. To set-up the auto run feature, proceed as follows:

1. Enter configuration (CONFIG) by pressing and holding **F1** and pressing **SETUP**.
2. At the first menu level of configuration, press the **EXECUTE TEST PROGRAM** key, then F1. The display shows the name of the current file to **"Auto run"** or **"\*NONE\*"** if auto run is not selected. To change this selection use the [NEXT] and [PREV] keys and when the correct file is displayed press [SEL]. To de-select auto run press [NONE].

## HELP

- The **HELP** key provides help on each key. The help message generally gives associated functions and ways of changing the use of each key. To get help on any of the keys on the key-pad:
  - ▣ Press **HELP**, then press the required key for information.
  - ▣ Some help screens show a flashing [MORE] over the F4 key, press F4 for further information.
  - ▣ Press **CLEAR/QUIT** to exit the help system.

## ▼ or ▲ (nudge keys)

- Change the current aim up or down ▲ by a small increment.
- This facility can be used to align a pointer of an instrument to a precise indicated value and compare this indicated value with the measured value.
  - This facility may be used for pressure switch testing as follows:
    - Aim for a pressure just below the expected operating point.
    - When the pressure is achieved, repeatedly press ▲ until the switch operates.
    - Record the pressure reading shown on the display.
    - Repeat this procedure using the ▼ until the switch returns to its original condition, refer to section 3 for an example.
    - Holding the nudge function automatically repeats the function. Record the pressure reading shown on the display.
  - See **SETUP**, ▼ or ▲ to change the value of increment for the nudge facility.

**CAUTION:** MAKE SURE THE NUDGE INCREMENT IS SET TO A SUITABLE VALUE BEFORE USING THE NUDGE FACILITY TO CHANGE THE AIM VALUE.

- Holding down ▼ or ▲ key automatically repeats the function.
- The nudge value can be used for large increments e.g., 100 kts or 5000 ft to "step through" cardinal points on a test.

## 0 to 9

- Use these keys for numeric entry. Press **ENTER** to complete numeric entry. Press **CLEAR/QUIT** if a mistake is made during numeric entry.
- All data entry is based on over-writing the existing value. When the first numeric key is pressed, the existing number is replaced by the key pressed. At any time, the existing number may be recovered by pressing **CLEAR/QUIT**.



### -000

- This key performs two functions during numeric entry.
- If it is the first numeric key pressed, it produces a minus sign for the entry of negative numbers.
- If it is not the first key pressed during numeric entry, it produces three zeros for fast entry of thousands e.g. to enter -1000:
  - Press -000 (Display shows -)
  - Press 1 (Display shows -1)
  - Press -000 (Display shows -1000)

**Note:** When **-000** is pressed during entry of an aircraft name for limits or in the Print facility, it always produces "-".

### CLEAR/QUIT

- During numeric entry, **CLEAR/QUIT** removes the new number and restores the previously entered number.

**Note:** Once the **ENTER** key has been pressed, the old number cannot be restored.

- When menus are displayed, **CLEAR/QUIT** exits the menu, generally to the previous display.
- For those displays containing a [SAVE] option, changes made before pressing **CLEAR/QUIT** are ignored. For all other displays, pressing **CLEAR/QUIT** saves the changes.
- When warning messages are displayed, pressing **CLEAR/QUIT** removes the message.

**ENTER**

- The **ENTER** key completes numeric entry.

**CLEAR/QUIT + ENTER (ABORT)**

- Pressing **CLEAR/QUIT** and **ENTER** together, restarts the ADTS 405 from the power-up sequence.
- Output valves close immediately and open during the restart sequence.

**Note:**

*The restart sequence starts with the display showing:*



DRUCK  
ADTS 405  
DK127  
Iss 5.xx

- The (ABORT) function should only be used as a last resort:
- ▣ When a restart is required after the system has shutdown displaying an error message.
- ▣ As an emergency measure with a serious problem concerning the aircraft or component under test.
- After this restart sequence, the system vents, at a safe rate, both channels (pitot and static) to atmosphere during the power-up sequence.

## 6.3 SETUP

Pressing the **SETUP** key causes the system to enter a set-up mode preset in the configuration mode. The following section describes the three functions of setup: Full, Minimum and Off. The full set-up allows access to all set-up functions. Minimum set-up allows access to some set-up functions, the off function prevents access to the set-up functions.

### FULL SET-UP

- Full set-up allows access to secondary functions that do not have an assigned key. Any parameter changed under set-up returns to the default settings on power-down.
- The CONFIGURATION mode may be used to change the default settings so that the ADTS 405 powers up in the required state. Most set-up parameters are also available under CONFIG. Additional parameters are only available under CONFIG.
- Certain parameters in set-up can be locked in CONFIGURATION mode preventing inadvertent changes such as aircraft limits at power-up with a particular set of limits that must not be changed. Attempting to change a locked parameter causes the display to show a warning message.
- Pressing the **SETUP** key makes the set-up functions available. Pressing the function keys selects the set-up menus, using the appropriate function key selects the required menu choice. To set-up a parameter key, press **SETUP** then press the required parameter key. Each parameter key set-up provides settings to the normal user mode function of the key. Further menus are used under certain direct key set-up functions.

**Note:** *The Quick Reference Section of this manual provides details of the set-up menus and keys.*

- Once a setting has been changed in set-up, use **CLEAR/QUIT** to return to the preceding menu. After all required parameters have been changed, repeatedly press **CLEAR/QUIT** until the display shows the main pressure display.
- The following section describes each set-up function. Intermediate menus are not described.

**SETUP, [UNITS]**

- Use [NEXT] or [PREV] to step through the available units until the display shows the required units. Select [SAVE] and then press [QUIT] to make the selection.

The available units are:

ft and kts (includes Mach)	inH <sub>2</sub> O 4°C
ft and mph (includes Mach)	inH <sub>2</sub> O 20°C
m and km/h (m/min) (includes Mach)	inH <sub>2</sub> O 60°F
m and km/h (m/s) (includes Mach)	psi
m and km/h (hm/min) (includes Mach)	hPa
mbar	kPa
inHg	kg/cm <sup>2</sup>
mmHg	% full-scale

**SETUP, [LIMITS]**

- The ADTS 405 is preprogrammed with the manufacturer's STANDARD, CIVIL and MAX\* limit sets. Different sets of additional aircraft limits can be programmed using the CONFIG mode. SETUP, [LIMITS] allows the selection of the set of limits to be used, each set of limits is identified by its aircraft name.

**Note:** *\*The ADTS 405, when delivered, contains "Standard" and "Civil" limits; to set and store "Max" limits, for the first time, enter configuration. The "Max" limits depend on the range of the pitot channel either 850 or 1000 knots, see section 1.3, operating limits.*

- Use [NEXT] or [PREV] to step through the aircraft names select [SEL] and press QUIT when the display shows the required name.
- Use CONFIG, [LIMITS] to program the sets of limits. Each set of limits includes:

Max ALT	Min Ps
Min ALT	Max Qc
Max CAS	Min Qc
Min CAS	Max Rate Ps
Max Mach	Max Rate Qc
Max ROC	ARINC limits on or off
Max Rate CAS	Altitude correction value
Max Ps	

- The set of limits used at power-up (default) can be selected using CONFIG, [LIMITS], [DEFAULT AIRCRAFT]. The default aircraft settings can be locked using CONFIG, [LIMITS], [LOCK AIRCRAFT] so that the operator cannot change the limits.

- If the selected set of limits result in the measured pressures being outside the limits, the display shows the warning message **"OUTSIDE LIMITS GO TO GROUND"** the Ps and Pt channels should be taken to ground or to pressures within the new selected limits. This warning message is also displayed if the pressures measured directly after power-up are outside the limits used at power-up.
- After selecting a set of limits, the altitude correction value can be changed using **SETUP, ALT**. The maximum Mach limit can be changed or switched off using **SETUP, MACH**.

### SETUP, [OSC]

- The ADTS 405 has an oscillation facility that causes the pressure to oscillate about the aim value at a user defined frequency and amplitude.
  - ▢ Select oscillation channel Ps or Pt.
  - ▢ Select [AMPL/FREQ] and enter the required amplitude and frequency.
  - ▢ Select [START] to start oscillation.
  - ▢ Select [STOP] to stop oscillation at the end of a half cycle.
  - ▢ Select [FREEZE] to stop oscillation immediately.

### SETUP, [MORE], [CONTROL], [Ps Pt DUAL]

- Dual channel is the normal mode of operation where both Ps (static) and Pt (pitot) channels are connected to the unit or aircraft system under test.
- To test instruments such as airspeed indicators with only the Pt (pitot) channel connected, use **SETUP, [MORE] [CONTROL] [Ps Pt DUAL]** and select [Pt].
- When using [Pt ONLY], the blanking cap must be removed from the Ps (static) channel so that Ps is open to atmosphere. All the functions associated with the Ps channel are disabled.

Similarly, to test instruments such as altimeters with only Ps (static) channel connected, use **SETUP, [MORE] [CONTROL] [Ps Pt DUAL]** and select [Ps]. All the functions associated with the Pt channel are disabled; the blanking cap can remain fitted to this channel.

- To return to dual channel operation, select **SETUP, [MORE], [CONTROL] [Ps Pt DUAL]** and select [DUAL] and connect both channels to the unit or aircraft system under test.
- The channel controllers must be in measure mode when changing [CONTROL].
- The Ps (static) pressure must be within  $\pm 10$  mbar of the recorded QFE to select Pt only.
- The control channel selection can be locked in CONFIG.

**SETUP, [MORE], [DISPLAYS/OPTIONS], [DISPLAY TYPE]**

- The display can be configured for SINGLE, DUAL or TRIPLE displays. The key press sequence changes the display parameters, the 2nd key press column shows the parameter that changes on entry of a numeric value. The tables show all available parameter combinations with an associated key press sequence.

1st Key Press	2nd Key Press	Upper Display	Lower Display
ALT	SPEED	ALT	CAS or TAS
ALT	MACH	ALT	MACH
Any key	ROC	ALT	ROC
SPEED	RATE	CAS or TAS	RATE CAS
MACH*	RATE	MACH	RATE MACH
SPEED	MACH	MACH	CAS/TAS
SPEED	ALT	ALT	SPEED
MACH	ALT	ALT	MACH
MACH	SPEED	MACH	SPEED

\* The Mach parameter changes on numeric entry

**Aeronautical units dual display**

1st Key Press	2nd Key Press	Upper Display	Lower Display
Ps	Qc	Ps	Qc
Ps	Pt	Ps	Pt
Ps	EPR	Ps	EPR
Any key	RATE Ps	Ps	RATE Ps
Qc	RATE	Qc	RATE Qc
Pt	RATE	Pt	RATE Pt
EPR	RATE	EPR	RATE EPR
Pt	Qc	Pt	Qc
Qc	Ps	Ps	Qc
Pt	Ps	Ps	Pt
EPR	Ps	Ps	EPR
Qc	Pt	Pt	Qc

**Pressure units dual display**

1st Key Press	2nd Key Press	Display
Any key	SPEED	ALT, CAS or TAS
Any key	MACH	ALT, CAS or TAS, MACH
Any key	ROC	ALT, CAS or TAS, ROC
SPEED	RATE	ALT, CAS or TAS, RATE CAS
Any key	ALT	ALT, CAS or TAS

Aeronautical units triple display

1st Key Press	2nd Key Press	Display
Any key	Qc	Ps, Qc
Any key	Pt	Ps, Qc, Pt
Ps	EPR	Ps, EPR
Any key	ROC	Ps, Qc, RATE Ps
Qc	RATE	Ps, Qc, RATE Qc
Pt	RATE	Ps, Pt, RATE Pt
EPR	RATE	Ps, EPR, RATE EPR
Qc	Ps	Ps, Qc
EPR	Ps	Ps, EPR

Pressure units triple display

- At the end of rate timing, the rate of change on both channels are displayed for aeronautical units ROC and RATE CAS and for pressure units RATE Ps, RATE Pt and RATE Qc.

**Note:** This is the same for all display modes.

Option Displays

- The key presses function, for the option displays, in the same way as a "single display" (i.e., the single displayed parameter comes from the last key press), with the lower half of the display screen showing any available data from the option.

**SETUP, [MORE], [DISPLAYS/OPTIONS], [OPTIONS]**

- This function allows changes to option hardware that may be fitted. - See option manuals for further details.
- If an option that is not fitted is selected the display shows the error message "**Option Hardware not fitted**". Refer to the option user manual.

**SETUP, [MORE], [CLOSE OUTPUT VALVES]**

- This function closes the Ps and Pt valves to enable leak checking of the internal pneumatics of the ADTS 405, with the aircraft system isolated, but still connected. All the normal functions of the ADTS 405 may be used in this mode.

**Note:** *For safety, the output valves can only be closed when the ADTS 405 is at ground.*

**SETUP, [MORE], [OPEN OUTPUT VALVES]**

- This function opens the Ps and Pt output valves after using the [CLOSE OUTPUT VALVES] function.

**Note:** *For safety, the output valves can only be opened when the ADTS 405 is at ground.*

**SETUP, [MORE], [SYSTEM SELF TEST]**

- This function starts a self-test, the system pressures must be at ground pressure and the system in Leak Measure mode. The self-test is the same test routine as in the power-up sequence.

**Note:** *At the end of the self-test the output valves open.*



### SETUP, ALT (Figures 6-1 and 6-2)

- This function allows the altitude correction value to be changed. If altitude correction is in use the display shows, after warm-up, "**A/C**" in the lower right hand corner.
- The altitude correction facility corrects for the pressure difference when the ADTS 405 and the aircraft system or components under test are at different heights.
- If the ADTS 405 front panel is vertical, use the altitude reference level shown on the front panel. If the ADTS 405F front panel is horizontal, use the altitude reference level shown on the side of the case.
- Enter the height difference between the aircraft system and the ADTS 405 altitude reference level. The units of entry are the current units or default aeronautical units, see CONFIG, [UNITS], [AERONAUTICAL].

### SETUP, SPEED, [AUTO ZERO]

- This function enables or disables the auto zero function. When enabled, this optimizes airspeed accuracy at low airspeeds.
- When enabled the ADTS 405 performs an auto zero when the following conditions are met:
  1. Ps and Pt pressures are stable.
  2. If in control mode, a zero airspeed or Qc aim has been achieved.
  3. If in leak measure mode, the airspeed is less than 20 knots (or Qc equivalent).
- The auto zero will be initiated within one minute of achieving a new aim value and thereafter, every five minutes.
- The auto zero sequence can be interrupted at any time by entering a new command over the key-pad or option interface.
- The controllers must be in measure mode when enabling or disabling auto zero.

### SETUP, SPEED, [CAS/TAS]

- This function changes the airspeed display between Calibrated Airspeed (CAS or Vc) and True Airspeed (TAS or Vt). For testing purposes, CAS is equivalent to Indicated Airspeed (IAS).
- The value of TAS displayed depends on the Pt temperature, see SETUP, SPEED, [Pt TEMPERATURE].

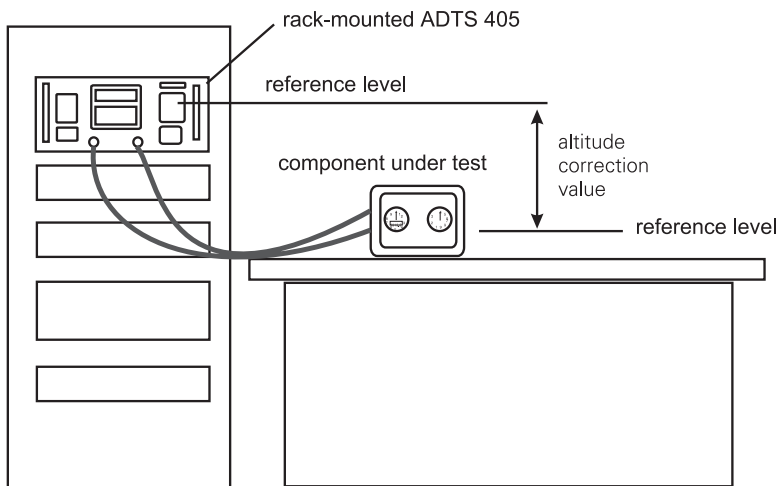

Corrected altitude = Altitude measurement + Altitude correction value

FIGURE 6-1 ALTITUDE CORRECTION RACK MOUNTING

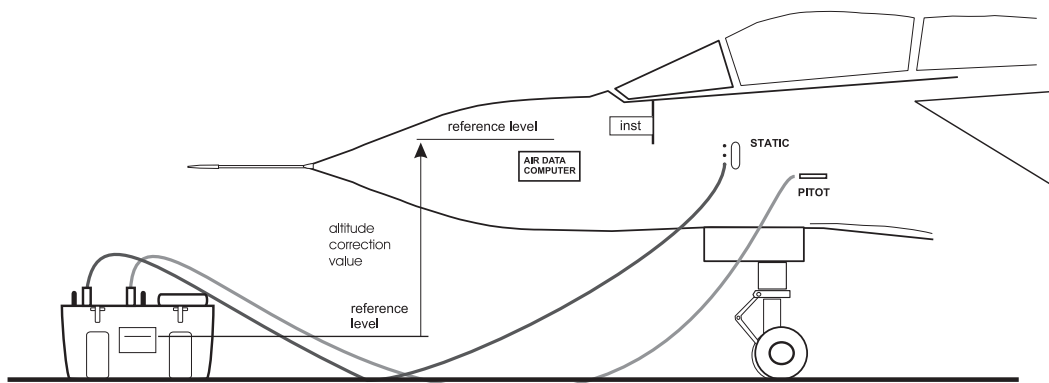

Corrected altitude = Altitude measurement - Altitude correction value

FIGURE 6-2 ALTITUDE CORRECTION ON-AIRCRAFT

### SET-UP, SPEED, [Pt TEMPERATURE]

- The function allows the value of Pt temperature to be entered, this is used in the calculation of TAS.
- Enter the Pitot temperature measured by the aircraft's Pitot temperature sensor in the units shown on the display.
- The default units of temperature measurement may be changed using CONFIG, [UNITS], [TEMPERATURE].

### SET-UP, MACH

- This function allows the Mach limit to be changed or disabled. The initial Mach limit comes from the current aircraft limits.
- To change the limit enter a numeric value or select as follows:
  - Select [OFF] to disable the Mach limit.
  - Select [ON] to enable the Mach limit.
  - Select [DEFAULT] to restore the Mach limit from the aircraft limits in use.

### SET-UP, RATE TIMER

- This function allows the Wait/Time values to be set for F1, F2, and F3 of the RATE TIMER function.
- To change the times:
  - Select the function to be changed: F1, F2 or F3.
  - Enter the [WAIT] value in minutes and seconds.
  - Enter 00:00 if a wait is not required.
  - Select [TIME].
  - Enter the [TIME] value in minutes and seconds.
  - Press **CLEAR/QUIT**.
  - Select another WAIT/TIME or press **CLEAR/QUIT**.
- See the **RATE TIMER** for further details.

### SET-UP, RATE

- This function selects automatic airspeed rate control ON or OFF.
- If the automatic airspeed rate is selected (using SETUP, RATE) the airspeed rate is automatically adjusted to simultaneously achieve both altitude and airspeed aim. This adjustment normally requires a reduction in the rate from the aim value; the rate does not exceed the aim value. When airspeed is automatically reduced, the display shows RATE CAS aim as **(A)**.
- This function only applies when using Aeronautical units (ft and kts, ft and mph, m and km/h (m/min), m and km/h (m/s), m and km/h (km/min)).

### SETUP, LEAK MEASURE CONTROL, [AUTO LEAK]

- This function enables or disables the auto leak recovery facility. See LEAK MEASURE/CONTROL for further details.

### SETUP, LEAK MEASURE CONTROL, [AUTO LIMIT]

- This function enables or disables the auto limit recovery facility. See LEAK MEASURE/CONTROL for further details.

### SETUP, GROUND

- This function enables the station (airfield) altitude to be entered and is used when displaying QNH. See GROUND for further details.
- Enter the station (airfield) altitude in the units shown on the display. See CONFIG, [UNITS], [AERONAUTICAL] for default units.

### SETUP, PORT

- This function sets up the port option.
- If an option, that is not fitted, is selected the display shows the error message "**Option Hardware not fitted**". Refer to the Line Switching Unit, User Manual.

### SETUP, PRINT, [DATE/TIME]

- This function allows the system time and date to be set. The time and date is maintained by a battery-backed clock when the ADTS 405 is switched off.
- Use [TIME] or [DATE] to select between time or date.
- To change the time or date, enter all six digits and press ENTER.
- The date format can be either US (mm/dd/yy) or UK (dd/mm/yy) using CONFIG,[MORE], [DATE FORMAT]. The time format is hh:mm:ss.

### SETUP, EXECUTE TEST PROGRAM

- This function sets up the results file options.
- Result data generated by the test program can either be sent out to the printer port or saved to a result file and stored in the ADTS 405. Pressing F1, the [PRINT/SAVE] key, sets the option.
- Any of the results files, stored in the ADTS 405, can be sent to the printer port. Press F2, the [PRINT FILE] key, to select the required file.

## SETUP, HELP

- This function provides help on the set-up key.

### SETUP, ▼ or ▲ (nudge keys)

- This function allows the increment value of the nudge key to be adjusted for every parameter.
- When **SETUP**, ▼ or ▲ are pressed, the display shows the value of nudge for the parameter last displayed.
- Enter a new value to replace the present value.
- Use [NEXT] or [PREV] to display other parameters.
- Press **CLEAR/QUIT** when the nudge values of all the required parameters have been changed.
- In aeronautical units, the parameters available are:  
ALT            CAS/TAS    MACH ROC    RATE CAS
- In pressure units, the parameters available are:  
Ps            Pt            Qc            EPR  
RATE Ps    -            RATE Qc    RATE EPR
- The nudge value can be used for large increments e.g., 100 kts or 5000 ft to "step through" the cardinal points of a test.

**CAUTION:**    **MAKE SURE THE NUDGE INCREMENT IS SET TO A SUITABLE VALUE BEFORE USING THE NUDGE FACILITY TO CHANGE THE AIM VALUE.**

## MINIMUM SETUP

- Minimum set-up allows access to a limited number of set-up functions. Any parameter changed under set-up returns to the default settings at power-down.
- The CONFIGuration mode may be used to change the default settings so that the ADTS 405 powers-up in the required state.

## SETUP, [UNITS], [AERO]

- The current operating limits are changed to the default aeronautical units. These units can be programmed using CONFIG, [UNITS], [AERO].

## SETUP, [UNITS], [PRESS]

- The current operating limits are changed to the default pressure units. These units can be programmed using CONFIG, [UNITS], [PRESS].

## SETUP, [LIMITS]

- The ADTS 405 is preprogrammed with the manufacturer's STANDARD, CIVIL and MAX\* limit sets. Different sets of additional limits can be programmed using the CONFIG mode. **SETUP**, [LIMITS] allows the selection of the set of limits to be used, each set of limits is identified by an aircraft name or component/system number.

**Note:** *\*The ADTS 405, when delivered, contains "Standard" and "Civil" limits; to set and store "Max" limits, for the first time, enter configuration. The "Max" limits depend on the range of the pitot channel either 850 or 1000 knots, see section 1.3, operating limits.*

- Use [NEXT] or [PREV] to step through the aircraft names and when the display shows the required name, press [SEL], then **CLEAR/QUIT**.
- Use CONFIG, [LIMITS] to program the sets of limits. Each set of limits includes:

Max ALT	Min Ps
Min ALT	Max Qc
Max CAS	Min Qc
Min CAS	Max Rate Ps
Max Mach	Max Rate Qc
Max ROC	ARINC limits on or off
Max Rate CAS	Altitude correction value
Max Ps	

- The set of limits used at power-up (default) can be selected using CONFIG, [LIMITS], [DEFAULT AIRCRAFT]. The default aircraft set of limits can be locked using CONFIG, [LIMITS], [LOCK AIRCRAFT] so that an operator cannot change the limits.

- If the selected set of limits result in the measured pressure values being outside the limits, the display shows the warning message "**OUTSIDE LIMITS GO TO GROUND**" the Ps and Pt channels should be taken to ground or to pressures within the new selected limits. This warning message is also displayed if the pressures measured directly after power-up are outside the limits used at power-up.
- After selecting a set of limits, the altitude correction value can be changed using **SETUP, ALT**. The maximum Mach limit can be changed or turned off using **SETUP, MACH**.

### SETUP, ALT/Ps (Figures 6-1 and 6-2)

- This function allows the altitude correction value to be changed. If altitude correction is in use the display shows, after warm-up, "**A/C**" in the lower right hand corner.
- The altitude correction facility corrects for the pressure difference when the ADTS 405 and the aircraft system or components under test are at different heights.
- If the ADTS 405 front panel is vertical, use the altitude reference level shown on the front panel. If the ADTS 405 front panel is horizontal, use the altitude reference level shown on the side of the case.
- Enter the height difference between the aircraft system and the ADTS 405 altitude reference level. The units of entry are the current units or default aeronautical units, see CONFIG, [UNITS], [AERONAUTICAL].

### SETUP, PORT

- This function sets the port option for the Druck Line Switching Unit .
- If an option that is not fitted is selected the display shows the error message "**Option Hardware not fitted**". Refer to the Line Switching Unit User Manual.

### SETUP, HELP

- This function provides help on the set-up key.

## 6.4 CONFIGURATION

- Any parameters, changed in any mode of SETUP, return to the default settings when the system is next switched on. The CONFIGuration mode may be used to change the default settings so that the ADTS 405 powers-up in a specified state. Most SETUP parameters are also available in CONFIG; other parameters are only available in CONFIGuration.
- Some parameters, changed in set-up mode, can be locked in CONFIGuration preventing access. For example, a system used in a servicing procedure for a specific aircraft type can be set to power-up with a specific set of limits that must not be changed. The set-up menus can also be locked out or access restricted preventing changes to operating parameters.

### Procedure

- Holding down **F1** then pressing **SETUP** causes the system to enter CONFIGuration mode. CONFIGuration may be password protected using a four digit PIN. If PIN protected, the display prompts for entry of the PIN. Press each digit of the PIN in turn (ENTER is not required) as each digit is entered, an asterisk appears. If an incorrect PIN is entered, the complete PIN is requested again.
- ▣ When the correct PIN is entered, the CONFIG menu appears.
- ▣ The PIN may be changed using CONFIG,-000.
- To use the configuration menu, press the appropriate function key to select the required menu item. To configure a parameter key, enter configuration menu then press the required parameter key. Each parameter key configuration provides changes to the normal user mode function and to the settings available in the set-up menu.
- Once a parameter has been changed in configuration, use **CLEAR/QUIT** to return to the previous menu. After all required key parameters have been changed, repeatedly press **CLEAR/QUIT** until the display shows the normal operating mode.

### Functions

- In the following section, each description of a CONFIGuration function is headed by the menu/key sequence required to select it. Intermediate menus are not described. Many of the functions are equivalent to the set-up functions; refer to SETUP for the details of the function.



**CONFIG, [UNITS]**

- o This function allows the default units to be configured.
- o The default [AERONAUTICAL] units are used at power-up for the altitude (and airspeed) display. The default units are also used for the limits entry in CONFIG and entry of any altitude or airspeed related functions in SETUP or CONFIG e.g., airfield altitude or altitude correction.
- o The default [PRESSURE] units are used for limits entry in CONFIG and entry of any pressure values in SETUP or CONFIG.
- o The default [TEMPERATURE] units are used for entry of temperature values in SETUP or CONFIG.
- o The default [AERONAUTICAL] and [PRESSURE] are set in MINIMUM SETUP, [UNITS].

**CONFIG, [LIMITS], [EDIT LIMITS], [EDIT EXISTING]**

- o This function allows existing sets of limits to be configured.
- o Use [NEXT] or [PREV] to select the set of limits by aircraft name or component/system name/number when the display shows the required limits, press [SEL] to edit the limit values.
- o Use [NEXT] or [PREV] to step through each limit or associated parameter in turn. Enter a new numeric value to change a limit.
- o Press **CLEAR/QUIT** when all required changes have been made and select [YES] to save changes. The parameters are:

Name	Max Ps
Max Alt	Min Ps
Min Alt	Max Qc
Max CAS	Min Qc
Min CAS	Max Rate Ps
Max Mach	Max Rate Qc
Max ROC	ARINC Limits
Max Rate CAS	Altitude Correction

**NOTES**

- 1** *The ADTS 405, when delivered, contains "Standard" and "Civil" limits; to set and store "Max" limits, for the first time, enter configuration. The "Max" limits depend on the range of the pitot channel either 850 or 1000 knots, see section 1.3, operating limits.*
- 2** *The system's defined "STANDARD", "CIVIL" and "MAX" limit sets cannot be redefined. A defined set can be edited but must be saved using a different name. This method could save time.*

**NAME**

- The aircraft name or component/system name/number is used for selecting the set of limits in SETUP or CONFIG. Enter up to 8 characters using 0 to 9, - (minus), . (decimal point) and any alphabetic characters in any order or combination.
- To enter a alphabetic character (A to Z), press [ALPHA] and use the nudge keys to change to the required character. Press [ALPHA] again to enter another alphabetic character. Press [BACK] to delete the last character. When editing text use the **CLEAR/QUIT** key to cancel editing.

- **MIN ALT, MAX ALT, MIN CAS, MAX CAS**

These are the fundamental aeronautical unit limits.

- **MAX MACH**

This limit only applies in aeronautical mode. It can be used to set a maximum Mach (e.g., Mach 1.05).

If a Mach limit is not required, enter a high value (e.g., 10).

The Mach limit can be changed or disabled in full set-up mode using **SETUP**, [MACH], see SET UP, MACH for further details on Mach limits.

- **MAX ROC, MAX RATE CAS**

These limits are the maximum rate of change for altitude and airspeed and only apply in aeronautical units.

- **MIN Ps, MAX Ps, MIN Qc, MAX Qc**

These are the fundamental pressure unit limits.

- **MAX RATE Ps, MAX RATE Qc**

These limits are the maximum rate of change for Ps and Qc and only apply in pressure units.

- **ARINC LIMITS (Figure 6-3)**

ARINC 565 operating limits are enabled by setting ARINC LIMITS ON and implemented as shown in Fig. 6-3.

Due to the shape of the altitude/airspeed envelope, these limits cannot be implemented using the above altitude, airspeed and Mach limits.

Using the [ON/OFF] function key select the required ARINC limits ON or OFF.

When used in combination with another set of limits, the lower (more restricting) limits apply.

If ARINC limits are selected and any of the other limits are greater than the values of the ARINC limits a display message requests confirmation that the lower, ARINC limit, is to be used before the limit is saved.

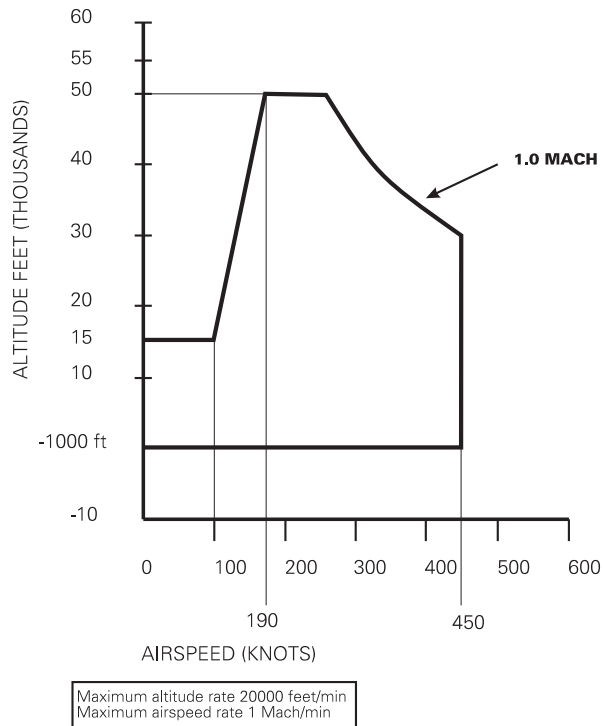

FIG 6-3 ARINC 565 OPERATING LIMITS

### ALTITUDE CORRECTION

- The altitude correction value for a specific aircraft may be entered as well as its limits.
- The altitude correction value can be changed during operation in full and minimum set-up modes using **SETUP**, [ALT]. See **SETUP**, [ALT] for further details on altitude correction.

### SAVING LIMITS

- When all limits and associated functions are set, press **CLEAR/QUIT** to exit the limit editing screen.
- If changes have been made, the display shows a request for confirmation before saving the changes.
- If the system detects any errors (e.g., duplicate aircraft names, values out of range or editing system-defined limits) the display changes to the edit screen for the error to be corrected.

**CONFIG, [LIMITS], [EDIT LIMITS], [MAX LIMITS]**

- This function makes a set of maximum limits; a set of MAX limits can be edited using CONFIG, [LIMITS], [EDIT LIMITS], [EDIT EXISTING] and saved with a new name. This is a quick method for setting-up a set of limits similar to the maximum system limits.
- The system displays an error message if MAX limits already exist.

**CONFIG, [LIMITS], [EDIT LIMITS], [EDIT NEW]**

- This function is identical to [EDIT EXISTING] and creates a new set of limits. Default values are taken from "Standard" limits. See [EDIT EXISTING] above for further details.

**CONFIG, [LIMITS], [CLEAR LIMITS]**

- This function clears an existing set of limits. Use [NEXT] or [PREV] to display the name of the limits. Select [SEL] to clear the limits followed by [YES].

**CONFIG, [LIMITS], [LOCK AIRCRAFT]**

- This function prevents changes to the default limits.
- If lock is [ON], no changes to the power-up default aircraft limits can be made from set-up.

**CONFIG, [LIMITS], [DEFAULT AIRCRAFT]**

- This function selects the set of limits used at power-up.
- Use [NEXT] or [PREV] to display the name of the required limits. Select [SEL].

**CONFIG, [MORE], [CONTROL], [CONTROL MODE]**

- CONFIG equivalent of SETUP function.

**CONFIG, [MORE], [CONTROL], [CONTROL LOCK]**

- This function prevents changes to the default CONTROL SETTING.
- If lock is [ON], no changes to the control channel selection can be made from set-up.

**CONFIG, [MORE], [DISPLAY/OPTIONS], [DISPLAY TYPE]**

- CONFIG equivalent of SETUP function.

**CONFIG, [MORE], [DISPLAY/OPTIONS], [OPTIONS]**

- Refer to the option user manuals.

**CONFIG, [MORE], [DATE/FORMAT]**

- This functions allows the display date format to be selected between [MDY] (mm/dd/yy) and [DMY] (dd/mm/yy).

**CONFIG, [MORE], [SETUP MODE]**

- This function enables, disables or limits access to the secondary functions. There are three set-up modes:

**FULL**

- ▣ This mode provides complete access to all secondary functions when the **SETUP** key is pressed. All pressure and aeronautical units can be selected.

**MINIMUM**

- ▣ This mode provides limited access to the secondary functions when the **SETUP** key is pressed. This prevents access to error recovery, rate timers etc. Units can only be changed between two pre-selected types, for full details see section 6.3.

**OFF**

- ▣ This mode prevents access to all secondary functions.

**CONFIG, SPEED, [AUTO ZERO]**

- CONFIG equivalent of SETUP function.

**CONFIG, SPEED, [CAS/TAS]**

- CONFIG equivalent of SETUP function.

**CONFIG, SPEED, [Pt TEMPERATURE]**

- CONFIG equivalent of SETUP function.

**CONFIG, RATE TIMER**

- CONFIG equivalent of SETUP function.

**CONFIG, RATE**

- CONFIG equivalent of SETUP function.

**CONFIG, LEAK MEASURE, [AUTO LEAK ON/OFF]**

- CONFIG equivalent of SETUP function, see LEAK MEASURE/CONTROL for details.

**CONFIG, LEAK MEASURE, [AUTO LEAK LOCK]**

- Prevents changes to AUTO LEAK setting in SETUP.

**CONFIG, LEAK MEASURE, [AUTO LIMIT ON/OFF]**

- CONFIG equivalent of SETUP function, see LEAK MEASURE/CONTROL for details.

**CONFIG, LEAK MEASURE, [AUTO LIMIT LOCK]**

- Prevents changes to AUTO LIMIT setting in SETUP.

**CONFIG, GROUND**

- CONFIG equivalent of SETUP function.

## CONFIG, PORT

- Refer to the Line Switching Unit User Manual.

## CONFIG, REMOTE

**CAUTION:** CHANGING BETWEEN SETS OF LIMITS CAN CAUSE DAMAGE TO SENSITIVE INSTRUMENTS. ENTERING CONFIG DISABLES LOCK OUT THERE ARE TWO SETS OF LIMITS: "REMOTE" AND "LOCAL".

- This function disables the front panel key-pad and allows the ADTS 405 to be controlled by a remote device such as a PC. The front panel display shows the "REMOTE" message. To return to "local" control (key-pad) press **REMOTE/LOCAL** key, the remote device can disable this key.

**Note:** *Some ATE systems may require the ADTS 405 set in the remote mode before the remote device starts communicating. If remote lock is disabled, set the ADTS 405 while in local control, by pressing the **REMOTE/LOCAL** key.*

## CONFIG, ETP, [AUTO RUN]

- Causes a down-loaded test program to operate (Execute Test Program) on power-up. See the Test Program Manager User Manual for further details.

## CONFIG, ETP, [ERASE PROGRAMS]

- Removes a down-loaded test program from non-volatile memory. See the Test Program Manager User Manual for further details.

## CONFIG, ETP, [RESULT]

- Configures the PRINT/SAVE mode as in set-up mode.
- Selects and deletes a result file stored in the ADTS 405.

## CONFIG, ▼ or ▲ (nudge keys)

- CONFIG equivalent of SETUP function.

## CONFIG, 000

- This function enables, changes or disables the CONFIG PIN code protecting access to CONFIG menu.
- When enabled, the PIN must be entered before it can be changed. The prompt asks for "**Enter Existing PIN**", then a new PIN can be entered. This must comprise four numeric digits.
- Once entered, the prompt asks for the new PIN again to protect against data entry errors. To disable the PIN, so that CONFIG can be entered without a PIN, enter 0000.

**Note:** *Access to maintenance functions may also be PIN protected. This PIN number is not the same as the CONFIG PIN.*

## 6.5 Specification

### Physical Specification

Size	ADTS 405 ..... Standard 19" rack front panel 6U high (10½") ..... Depth behind front panel 255 mm (10") ..... Rear panel connections available
	ADTS 405F ..... 442 mm x 755 mm x 332 mm (17½" x 30" x 13")
Weight	ADTS 405 ..... 12 kg [26.5 lb] ADTS 405F ..... 29 kg [64 lb]
Power	..... Single phase AC in the range 90-260 V ..... Over the frequency range 47-440 Hz ..... No switching required - all automatic
	DC power option ..... 24 to 30 V
	ADTS 405 ..... 400 VA ADTS 405F ..... 500 VA
Pressure Fittings	
	Ps ..... MS33656-6 Pt ..... MS33656-4 Pressure supply ..... MS33656-4 Vacuum supply ..... MS33656-6

### Pressure/Vacuum Requirements

The ADTS 405 requires a single vacuum inlet and a single air pressure inlet. At the control set-point operating into a leak tight system, no air is consumed. A single vacuum source is adequate for the rates detailed into the volumes listed with no crosstalk between Ps and Pt channels. A pump capable of 14 litres/min (0.39 cubic ft/min) is required.

The air pressure source should be clean dry air at a pressure of 3 to 6 bar (45 to 90 psi) with the ADTS 405 having an internal regulator to protect the controllers. Filtering should be to better than 15 microns and a flow rate equivalent to 2.8 litres/min (0.1 cubic ft/min) at the above pressure.

**Note:** *The Druck PV 103 is a 19" rack unit that meets the requirements of the ADTS 405.*

The integral pump rack provides all the requirements of the ADTS 405F.

### Warm-up

If the ADTS 405 temperature has stabilized within the operating temperature range before switching on, the ADTS 405 requires a warm-up period of 15 minutes to achieve the stated accuracy.

### Temperature

The ADTS 405 has the following temperature ranges:

Calibrated	.....	+5° to +35°C (+41° to +95°F)
Operating	.....	-10° to +50°C (+14° to +122°F)
Storage	.....	-40° to +70°C (-40° to +158°F)

## Measurement and Control Range Specifications

### Operating Range and Performance

The ADTS 405 is supplied in one of two full-scale ranges (850 knots or 1000 knots) for measurement and control of the pitot pressure channel. The following operating parameters are based on a 1000 knots capability test systems. Variations for 850 knots test systems are shown, where appropriate, in brackets.

For both full-scale ranges, limits are set pre-defined tabular limits known as STANDARD, CIVIL and \*MAX these can be selected through the SETUP menu.

**Note:**

*The ADTS 405 is supplied without \*MAX limits, a prompt in the SETUP limits menu asks for MAX limits to be created. This function automatically loads the maximum values appropriate for the full-scale range.*

Operators may also configure the display to aeronautical or pressure units but should be aware that when units of pressure are selected, wider full-scale pressure limits will be enabled for some parameters.



Performance expressed in example aeronautical units

	Altitude	Rate of Climb (ROC)	Calibrated Airspeed (CAS)	Mach	Rate of change of Airspeed
<b>Units</b>	feet	ft/min	knots	-	kts/min
<b>Maximum Range <sup>(1)</sup></b>	-3000 to 105,000	100,000	-100 to 1000	14.97	2000
<b>Calibrated or Standard Range <sup>(1)</sup></b>	0 to 80,000	9,000	-100 to 1000	5	700
<b>Accuracy <sup>(2)</sup></b>	±3 at 0 ±7 at 30,000 ±29 at 60,000	±1% of value	±0.5 at 50 ±0.07 at 550 ±0.05 at 1000	Better than 0.005	±5% of value
<b>Repeatability</b>	±1 at 0 ±2 at 30,000 ±7 at 60,000	±0.5%	±0.4 at 50 ±0.02 at 550 ±0.02 at 1000	0.001 rising to 0.005	-
<b>Resolution</b>	1	1	0.1	0.001	0.1

NOTES

- (1) Altitudes above 80,000 ft and the peak rates of climb are available but subject to the use of a suitable vacuum pump.
- (2) The accuracy figures stated relate to operation over the temperature range 5° to 35°C (+41° to +95°F).

Effect of Operating Temperature Range on Static Channel Altitude Errors

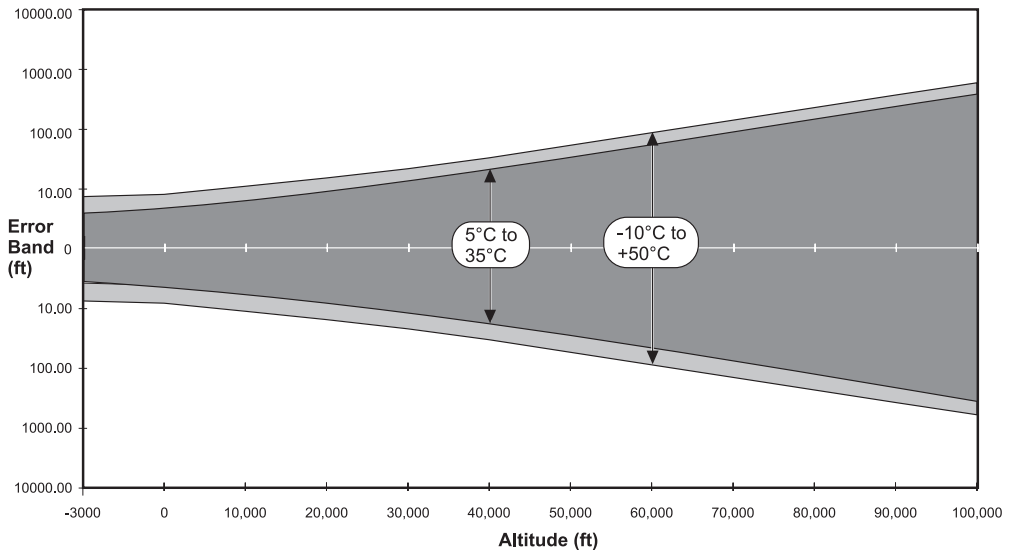

**Note:** The accuracy figures stated assume Auto-Zero function enabled.

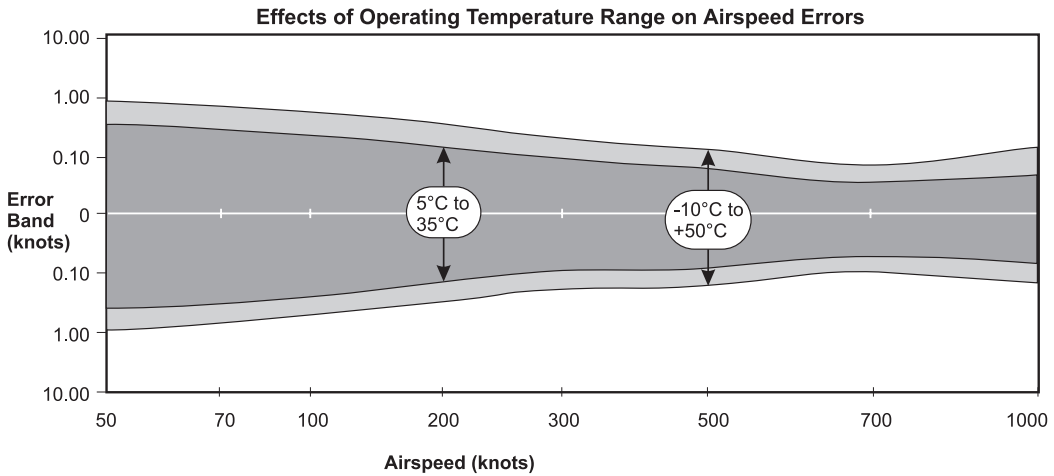

Performance expressed in example pressure units

	Static (Ps)	Rate Ps	Pitot (Pt)	Differential (Qc)	Rate Qc	EPR
<b>Units</b>	mbar abs	mbar/min	mbar abs	mbar diff	mbar/min	-
<b>Maximum Range <sup>(1)</sup></b>	3 to 1355	10,000	3 to 3500	-1352 to 3377	10,000	0.1 to 10
<b>Calibrated or Standard Range <sup>(1)</sup></b>	35 to 1355	200	35 to 3500	-1320 to 2500	200	0.1 to 10
<b>Accuracy <sup>(2)</sup></b>	±0.1	±1% within 5 seconds	±0.012% RDG +0.007% FS	RSS of Ps and Pt	±1% within 5 seconds	Better than 0.005
<b>Repeatability</b>	±0.05	±0.5%	0.05 to 0.17	-	-	-
<b>Resolution</b>	0.01	0.01	0.01	0.01	0.01	0.001

NOTES

- (1) Pressures below 35 mbar absolute and the peak rates of change are available but subject to the use of a suitable vacuum pump.
- (2) The accuracy figures stated relate to operation over the temperature range 5° to 35°C (+41° to +95°F).

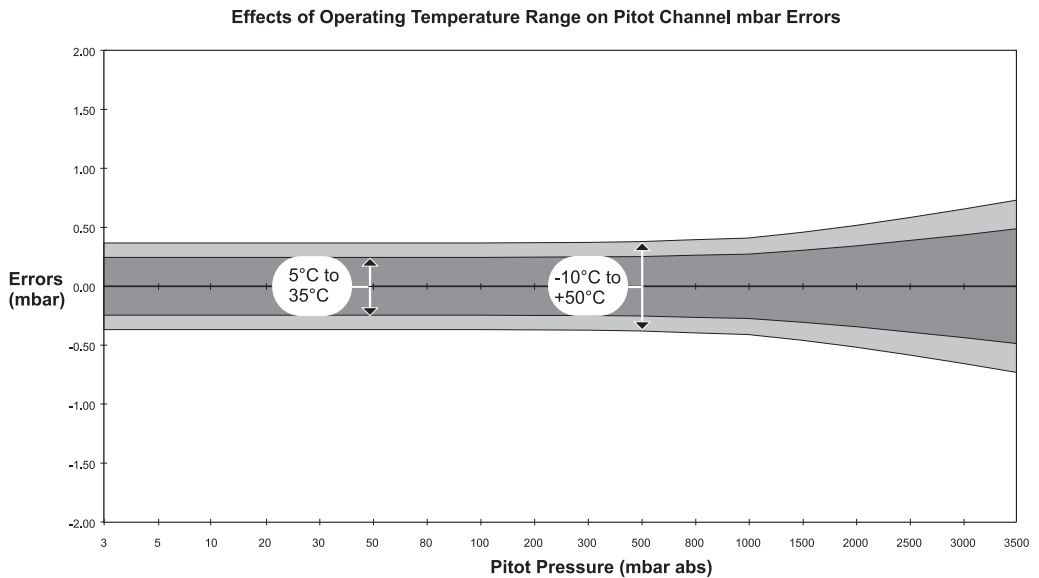
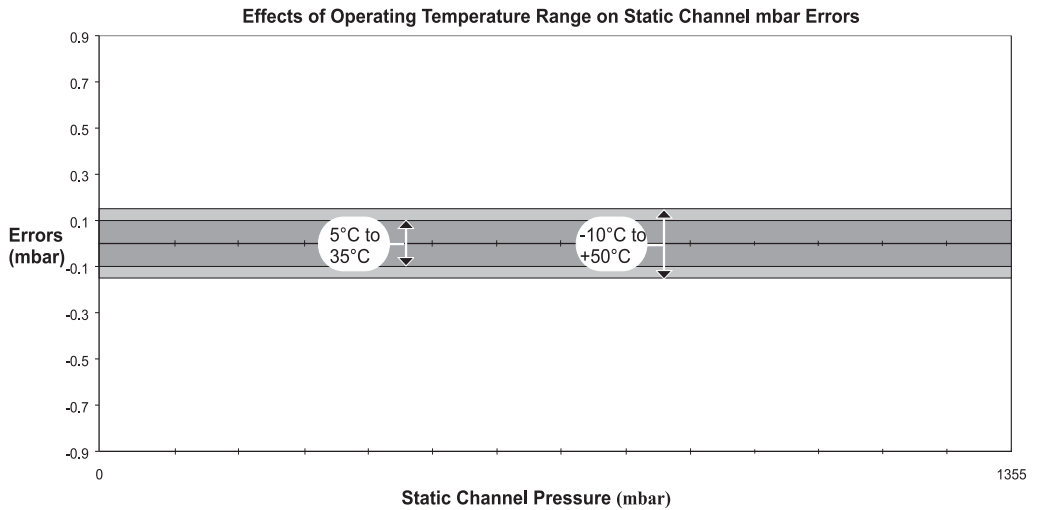

**Repeatability**

Repeatability is defined as the change or variation in reading when the same pressure is reapplied after an excursion between minimum and maximum of the range (i.e., including hysteresis). The repeatability does not include curve fit errors.

**Accuracy**

Accuracy figures stated include curve fit errors, repeatability and temperature effects over the range 5°C to 35°C (+41° to +95°F). The ADTS 405 can achieve the stated accuracy after a 15 minute warm-up period.

## Control Performance

### Stability

The ADTS 405 provides stable pressure values at the outlet ports and continues to control smoothly without oscillation into volumes of up to 17 litres (1,000 cubic inches) on Ps and a volume of up to 10 litres (600 cubic inches) on Pt at rates up to 6000 ft/min. Lower volumes enable higher rates of change to be achieved.

The following are the figures based on a 40 ppm of Ps full-scale or Qc full-scale over a bandwidth of 0.1 to 1.5 Hz and using RMS values. Below are shown the two Qc ranges used by the ADTS 405.

CHANNEL		CONTROLLER STABILITY
Ps	1,355 mbar 40 inHg	$\pm 0.038$ mbar $\pm 0.0011$ inHg
Qc	1,700 mbar 50 inHg	$\pm 0.045$ mbar $\pm 0.0014$ inHg
Qc	2,500 mbar 74 inHg	$\pm 0.070$ mbar $\pm 0.0021$ inHg

### Rate Control

The ADTS 405 operates in both aeronautical rates and pressure rates, e.g. ft/min and mbar/min and controls Ps, Pt and Qc parameters in either aeronautical or pressure units.

The following are possible:

- Ps - ft/min or metres/min - max rate 100,000 ft/min
- absolute pressure units/min
- Pt - absolute pressure units/min
- Qc - kts/min or km/h/min - max rate 2,000 kts/min
- differential pressure units/min

Using single vacuum pump, a rate of 20,000 ft/min can be achieved with a volume of 10 litres (600 cubic inches) connected to the static (Ps) channel and 6.7 litres (400 cubic inches) connected to the pitot (Pt) channel.

### Control Response

The required operating pressure value will be achieved without any overshoot, independent of the system volume, on either Ps or Pt channels. The system response to input commands takes place within a 400 millisecond period.

### Dynamic Testing

The ADTS 405 can generate sinusoidal variations of either the Ps or Pt or both channels. Frequency and amplitude of the required oscillation can be programmed; external volumes limit the achievable results. Maximum drift from the mean value during dynamic testing should be no more than twice that specified for steady state testing.

### Control Offset

The displayed value will be within the control stability values for the appropriate channel.

### Zone 2 Hazardous Area Definition

Defined as an atmosphere where explosive vapours may be present in an air breathable atmosphere.

**ONLY USE ATEX CERTIFIED EQUIPMENT IN THIS DEFINED AREA. USING NON-CERTIFIED EQUIPMENT RISKS AN EXPLOSION.**

In an aircraft hangar, explosive vapour may be present around an aircraft. The amount of explosive vapour varies and depends on local conditions such as hangar ventilation, prevailing metrological conditions and the density of explosive vapours. The local conditions must be assessed and the dimensions (x metre) of the hazardous area defined by the local engineering and safety officials.

**THE POWER SUPPLIES MUST BE ISOLATED WHEN CONNECTING ELECTRICAL EQUIPMENT IN THE HAZARDOUS AREA.**

**DO NOT DISCONNECT ATEX CERTIFIED ELECTRICAL EQUIPMENT SUCH AS THE ADTS HAND TERMINAL WHEN ENERGIZED IN THE HAZARDOUS AREA.**

