

Desktop Amplifier FA Plus2 Series

- Ideal for integration into facilities due to the box-shaped design
- Easy to combine with external devices such as PLC using the equipped output functions
- Fast sampling for both Peak Values and Continuous Data, achieving high reproducibility
- High RS232C data output speed (continuous data rate: 100 data/sec)
- Option of industrial power supply DC+24V is available



[Evolution to the Next Series]

Next Series is a generic term for IMADA measurement devices with upgraded functions and performances with the essential modifications. The devices enable to install additional functions from the user support site, IMADA-Connected. On the website, related data such as software and instruction manuals can also be downloaded. New Series: FA Plus2 Series Firmware Ver.5 or later.

New Features

- Increased measurement stability achieved from further noise reduction to the measurement circuit.

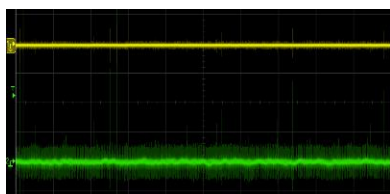

Analog output comparison
Yellow: Next series/Green: Old Model

- Measurement device program (firmware) online updates available.
- Various software and additional functions downloadable to increase the measurement conveniences.



IMADA-Connected
(<https://www.imada-connected.com/>)

Features	
Control Functions	<ul style="list-style-type: none"> - Adjustable baud rate to fit to your facilities such as PLC - Easy output of continuous data to your facilities such as PLC due to high RS232C data output speed (continuous data rate: 100 data/sec) - Accurate and quick force judgement due to high comparator data rate (2000 data/sec)
Management Functions	<ul style="list-style-type: none"> - Enables detection of load cell using A/D (Analog to Digital) value display - Reduces risks in operation by keeping a spare load cell using eZ Connect series

[Main Functions]

[Clear display]

-Reduces risk of misreading values with easy-to-read high luminance organic EL display

[Easy operation]

-Easy select of menu

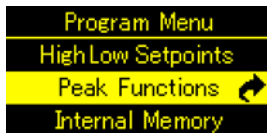

[Pass-fail judgement]

-Enables to judge by the LED light for the pass-fail results using comparator
-Alarm sounds for the fail result

[Quick force judgement]

-Quick force judgement with 2000 data/sec comparator data rate
-Allows quick communication with other devices

[Various output functions]

-Easy combining with external devices with various output functions
*Refer to P7 for the details of I/O connector
- High RS232C data output speed (continuous data rate: 100 data/sec)
-Adjustable baud rate to fit to your facilities such as PLC

[USB output function]

-Saves single and continuous data to USB flash drive and supplied software Force Logger

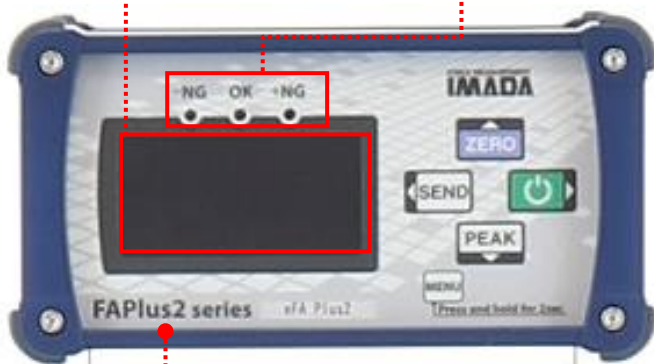

Front



Back

[Box-shaped design for easy integration]

Fits to your application

1. Standard use



Standard type

2. Integration into facilities



Optional mounting stay MSFF-A is mounted



Optional mounting stay MSFF-B is mounted

[Industrial power supply option available]

-Option: -DC
(Power: DC +24V, 500mA)



*AC adaptor is not included.

Specifications		
Model	FA Plus2	eFA Plus2
Features	Adjustment is required when change the load cell	Load cell interchangeable eZ Connect series (no need for adjustment)
Accuracy	The accuracy of connected load cell	The accuracy of connected load cell + +/- 0.2% F.S. (*1)
Unit of measurement	Depends on load cell and settings (N, kN, kgf, lbf N-m, N-cm, kgf-m, kgf-cm, lbf-in, ozf-in) (*2)	
Display	4-digit	
Display update	16 / sec	
Sampling rate	2000 data / sec at maximum (*3)	
Battery	AC adapter (AC100 to 240V) (*4)	
Operating environment	Temperature: 0 to 40 degree Celsius Humidity: 20 to 80%RH	
Functions	Customized display (header and footer), Peak hold (tension and compression), Comparator (judgment of OK or NG), Display of AD value, Reversible display, Zero clear timer, +NG alarm, Off timer (auto power off), Dumping, Time display, 1st/2nd peak, Displacement detection at force peak value, Displacement zero reset at selected force, setting lock	
Output	RS232C (baud rate available from 57600bps to 9600bps), USB, +/- 2VDC analog output (D/A), Comparator 3 steps (-NG/OK/+NG), Overload alarm, Sub comparator 2 steps (output of large or small judgment), USB flash drive, Displacement.	
Overload warning	Approx.110%F.S. (Warning message and alarm)	
Available liner scales	- Online driver output (a line receiver according to RS422/485 must be built in.) - Open collector output (Voltage drop between contacts must be smaller than 0.5V.)	
Weight	1100g	
Dimensions	Refer to dimensions	
Accessories	AC adapter (only for standard model), CD driver (including data logging software) (*5), USB cable, Adapter for USB flash drive (*6), Instruction manual	
	Inspection certification (when connecting load cell is purchased)	- (*7)

*1 Accuracy +/- 0.2% F.S. is added.

*2 The available units are different from Japanese domestic model and international one.

*3 When you save data in USB memory stick, the sampling rate is selectable among 1, 50 and 100/sec.

*4 Option of industrial power DC+24V is available. (Option: -DC)

*5 Refer to the below software details.

*6 USB flash drive is not included.

*7 We offer calibration certification for eFA Plus2 connected with the load cell at extra charge. Please contact us for details.

[Included Software]

-Force Logger: Data Acquisition Software

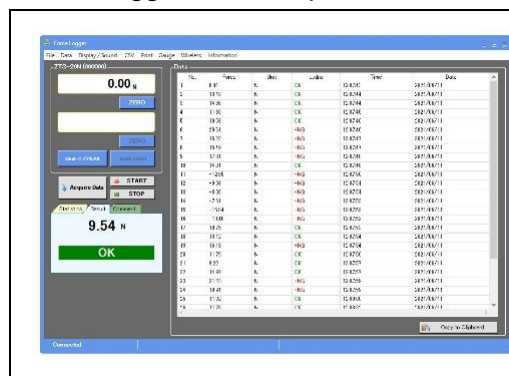

Main Functions

- Easy Importing of the Measurement Data
- Display Acquired Data Value Statistics: -Maximum / Minimum / Average Values.
- Data saved in CSV format
- Continuous Data acquisition up to 10 times per second.

Operating environment

- OS: 8.1/10/11
- Hardware: CPU 1GHz or more recommended
Memory 2GB or more recommended
Hard disk 10GB (Data storage area) or more
- Platform: .NET Framework 4.8 or later

Main Options			
Option	Model	Description	Product model
Industrial Power Supply (*1)	-DC	Industrial power supply: DC+24V, 500mA Enables to use in industrial power environment. (*1)	FA Plus2 eFA Plus2
Analog Volt	-AN	It outputs sensor data through analog voltage without conversion. (*2) Analog Cable CB-118 is required. (*3)	FA Plus2
High Accuracy (*4)	-HP□□	The accuracy is higher than standard type. Please input the accuracy of the load cell to □□ which you require. Please contact us for details.	FA Plus2

*Model with option follows the rules: FAP2-[load cell model]-[option model].





Example 1: FAP2-DPU-50N -DC -AN Example 2: eFA Plus2-DC Example 3: Accuracy of 0.2% is required FAP2-DPU-50N -HP0.2

*1 AC adapter is not included.

*2 The response speed is higher than D/A (standard), but zero reset is invalid, and noises may be detected as the data is not filtered.

*3 Cables are required when connected to multiple devices.

*4 Some load cells are not available for it. Please contact us for details.

Cables and linear scale			
Cable with Terminal Block CTB-A	Open End Cable CB-908	RS232C Cable CB-208	Built-in linear Scale DMK series
Allows for connection with liner scale and external equipment such as PLC (*1, *2, *3)	Allows for connection with external equipment such as PLC with 37-pin (*1, *2)	Enables data recording and operation from PC or PLC (*1, *4)	Enables the force-displacement testing by integrating into facilities (*1, *4)
			

*1 There is only one connector for one cable.

*2 Refer to P7 for the details of I/O connector.

*3 Specifications of terminal block is as follow.



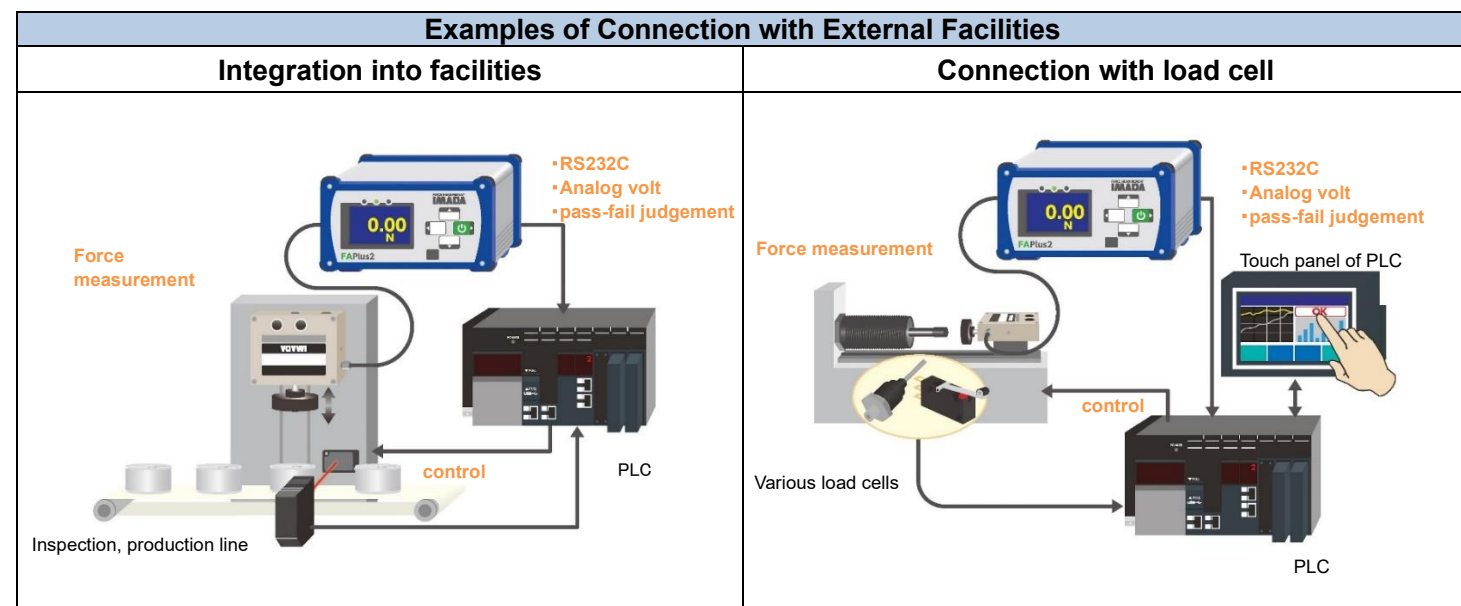

-Length of Supplied cable: approx.1m

-Insertable Cable Size: single cable $\phi 0.5$ to 1.6 , stranded cable 0.08 to 1.255 mm² / AWG28 to 16

*4 37-pin connector is the standard type. However, we also offer special type without connector if you need use cable with terminal block. Please contact us for details.





[Load cells]

Model	DPU series	SW series	SCX series	LU series	LMU series
Image					
Feature	Standard - Wide Use	Waterproof	Extra small	Small Size - Wide Use	Small Size
Force	Tension/Compression	Tension/Compression	Tension/Compression	Tension/Compression	Tension/Compression
Capacity	2N to 20kN	100N to 20kN	100N to 2000N	50N to 2000N	50N to 500N
Accuracy	+/- 0.2%F.S.	+/- 0.5%F.S.	+/- 1%F.S.	+/- 1%F.S.	+/- 1%F.S.
Cable Length	Up to 500N:2m 1000N to 20kN:3m	Up to 5000N: 0.5 to 2m(Curl cord) 10kN and 20kN:5m	3m	3m	2m

Model	PN-50N	LM series	LC series	CFX series	CLFX series
Image					
Feature	Pen type	Thin & Round	Round & Precise	Flat & Extra small	Flat & Thin
Force	Tension/Compression	Compression	Compression	Compression	Compression
Capacity	50N	10N to 20kN	500N to 20kN	20N to 200N	50N to 500N
Accuracy	+/- 2%F.S.	Up to 10kN:+/- 2% F.S. 20kN: +/-3.5% F.S.	+/- 0.5%F.S.	+/- 1%F.S.	+/- 2%F.S.
Cable Length	2m	Up to 2000N: 2m 5000N to 20kN: 3m	5m	3m	3m

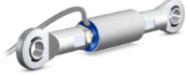
Model	CHX series	DD2 series	LMT-1000N	ZD series	SK series
Image					
Feature	Washer	High Accuracy & Waterproof	Wide range of temperature type	Small Size - High capacity	High accuracy
Force	Compression	Compression	Compression	Tension or Compression	Tension or Compression
Capacity	100N to 2000N	5000N to 20kN	1000N	1000N to 20kN	2000N to 20kN
Accuracy	Up to 500N: +/-2%F.S. 2000N: +/-1%F.S.	+/- 0.5%F.S.	+/- 1%F.S.	+/- 0.5%F.S.	+/- 0.25%F.S.
Cable Length	3m	5m	2m	3m	5m

Model	ZU series	ZW1-10kN	DM-2000N	PK1-500N	PK2-1500N
Image					
Feature	Attached Rod ends	Crane scale type	For door	for doors and windows	For car foot brakes
Force	Tension	Tension	Specialized	Specialized	Specialized
Capacity	10kN to 20kN	10kN	2000N	+/- 500N	1500N
Accuracy	+/- 1% F.S.	+/- 1% F.S.	+/- 2% F.S.	+/- 1%F.S.	+/- 1% F.S.
Cable Length	5m	0.5 to 2m	2m	1.5m	1.5m

Model	eHT series (*1)	eTFX series (*1)
Image		
Feature	Torque Load Cell	Torque Load Cell
Force	For torque	For torque
Capacity	0.5Nm to 10N-m	5N-m to 10N-m
Accuracy	+/- 0.5% F.S.	+/- 1% F.S.
Cable Length	0.5 to 1m (Curl cord)	2m

* Please refer to the specification sheet of each load cell for further details.

* The load cells with a  mark are eZ Connect series. eZ Connect series is composed of an amplifier and load cells. It enables to replace load cells without additional adjustment.

* SKM-1000N (not listed above) is not compatible with eZ Connect series.

* Add "e" to model name of a load cell for eZ Connect amplifiers.

*1 eHT series and eTFX series are only for eZ Connect series.

[Combined model]









Select a sensor (load cell) to combine with FA Plus2.

Example of combination

Amplifier + Sensor (Load cell)	Model
FA Plus2 + DPU-50N =	FAP2-DPU-50N (*1)
FA Plus2 + SW3-20kN =	FAP2-SW3-20kN (*1)

*1 FAP2 is abbreviation of FA Plus2. When purchase it, please write as FAP2.

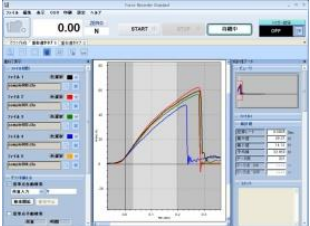
[Related Products]

Mounting Stay A Type MSFF-A	Mounting Stay B Type MSFF-B	Signal Tower Light PLU-03
They are useful for integration into facilities. Mounting to the panel type.	They are useful for integration into facilities. Mounting to the bottom type.	It shows the pass-fail results clearly. It can also alarm if the sensor is overloaded. (*1) 37-pin connector Length of cable: 3m
		
Foot Switch FSU-01R	Separated Sensor Model Digital Force Gauge ZT series	Sensor Interchangeable Indicator eZT
It can zero reset by stepping the switch. (*1, *2) 37-pin connector Length of cable: 1.5m	Indicator for hand use can be used in various testing environments with high accuracy and repeatability.	Indicator for eZ Connect series load cells and no need of adjustment when change load cell.
		
Data Graphing Software Force Recorder Series	Wireless Data Transmit System : WL01 series	
4 Software versions available for different requirements. (Force Recorder Light / Standard / Professional and Plus)	Transmits acquired measurement data to the device such as PC wirelessly.	
		

*1 37-pin connector is the standard type. However, we also offer special type without connector if you need use cable with terminal block. Please contact us for details.

*2 Please contact us for details if you have special requirements of output signal.

[I/O Connector]

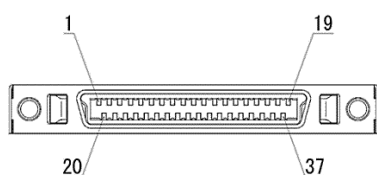

Connector Pin Arrangement		
Pin No.	Signal name	Description
1	-NG	High low setpoints of comparator output, wither signal is output depending on comparator judgement. (*1) (*4)
2	OK	
3	+NG	
4	SC1	Output depending on set high/low output values (*1) (*5)
5	SC2	
6	OVL	Overload output, Output when warning overload. (*1)
7	READY	Measurement-ready signal, Output when the display is ready to start measurement. (*1)
8	OUT GND	Grand common through pin #1 to 7.
9	ANALOG RAW +	Analog output (RAW) (*2) (*3)
10	ANALOG RAW -	
11	ANALOG D/A +	Analog output (D/A) (*2) (*3) Approx. +/-2V is output when max. force applied.
12	ANALOG D/A -	
13	232C_TxD	RS232C signal
14	232C_RxD	
15	232C_GND	
16	NC	N/A
17	NC	
18	NC	
19	NC	

Pin No.	Signal name	Description
20	NC	N/A
21	NC	
22	NC	
23	NC	
24	EXSW1:POWER	Input signal
25	EXSW2: ZERO	The functions differ depending on signal of Shift, Refer to the bottom of page of the page for details. (Detect edge signal when each pin connected to GND pin #30) (*6)
26	EXSW3: SEND	
27	EXSW4: PEAK	
28	Rec	
29	Shift	
30	GND	Input grand common through pin #24 to 29 and 32.
31	Mark Input	Input mark point
32	Scale A+	Displacement input (*7)
33	Scale A- (OC1)	Connectable linear scale and rotary encoder. (Corresponds to line driver output and open collector output.
34	Scale B+	
35	Scale B- (OC2)	
36	+5V	External power supply +5V (*8)
37	GND	External power supply Grand

*1 Open collector output. (Please keep source voltage less than 30V and current of 10mA.)

*2 Please keep resistance 1kΩ and more.

*3 Differential voltage output between 2 wires.

*4 The judgement done based on the displayed value.

*5 Real-time value is referred for judgement at all times.

*6 Pin #24-29 and #30 are short-circuited: ON.

*7 Connect pin #32 (A+) and #34(B+) / #35(B-) in case of line driver output.

Connect pin #33(OC1) / #35(OC2) in case of open collector output. (Keep voltage drop 0.5V and less.)

*8 Enable to supply 5V 200mA at max. Make sure to charge with AC adapter when supply power to external equipment.

Input signal depending on Shift signal		
	Shift Input invalid	Shift Input valid
EXSW1	Turn on	Shut off
EXSW2	Same operation with ZERO button	Zero measuring displacement
EXSW3	Same operation with SEND button	(RESERVE)
EXSW4	Same operation with PEAK button	(RESERVE)
Rec	Control recording on software Force-Recorder series.	

[Dimensions]

FA Plus2/eFA Plus2

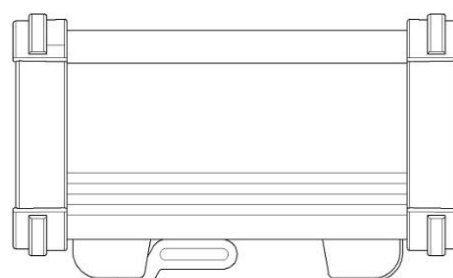
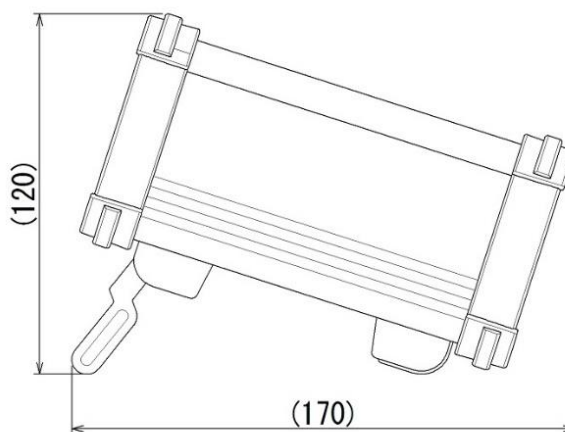
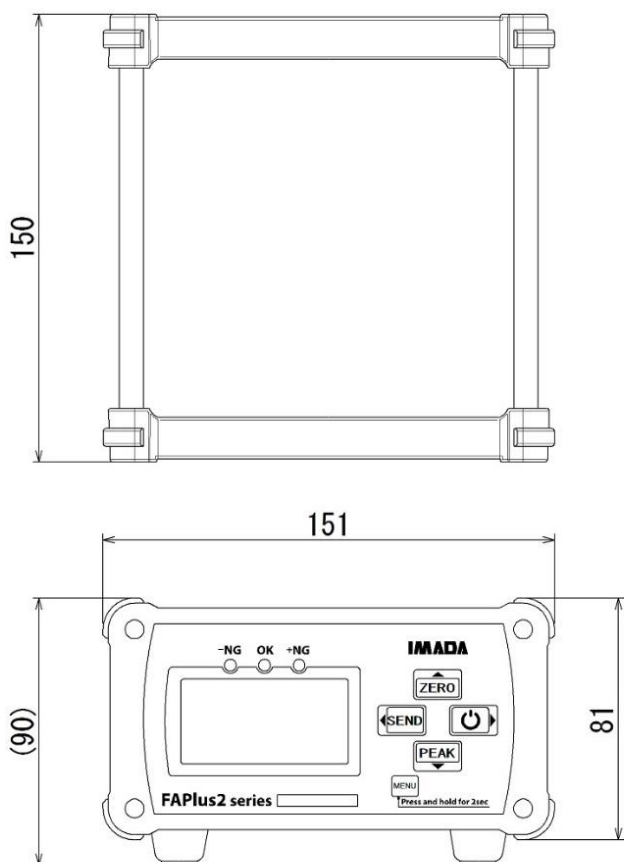

Unit: mm

When MSFF-A is mounted

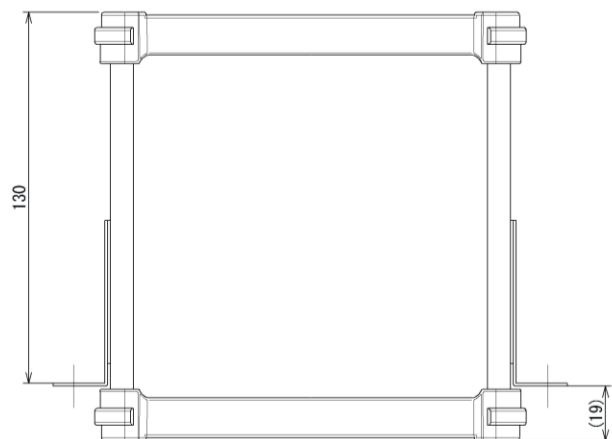

When MSFF-B is mounted

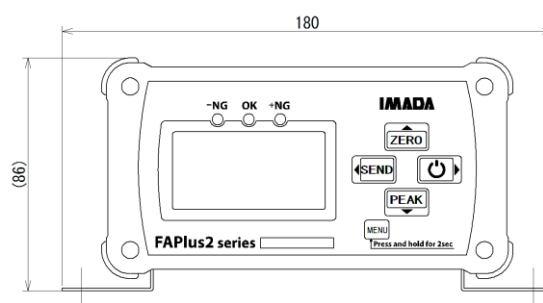
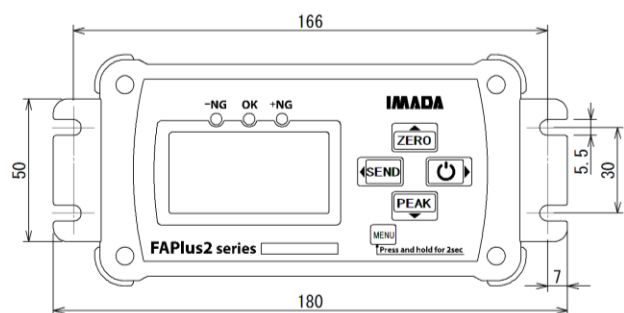
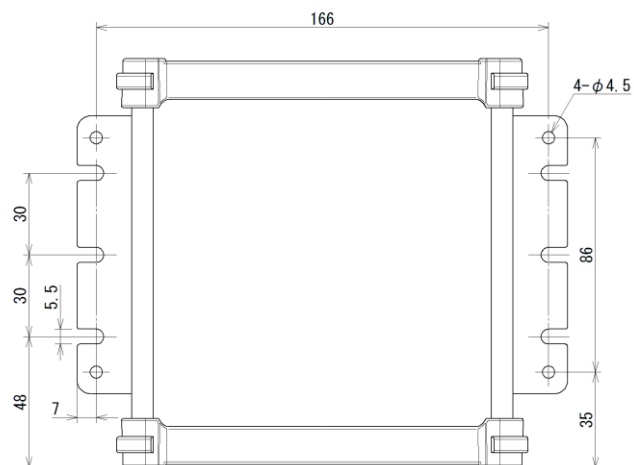

Panel

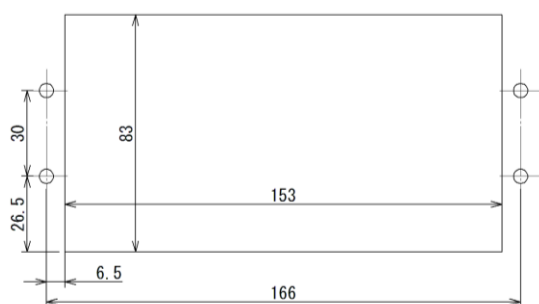

Unit: mm

[Calibration Certification and ISO/IEC17025 calibration service]

- We can offer calibration certification for FA Plus2 connected with the load cell.
- We offer calibration certification for eFA Plus2 connected with the load cell at extra charge.
- We also offer ISO/IEC17025 calibration service at extra charge.

* Please contact us or your local distributor for detailed information.

[Cautions]

- Specifications are subject to change without prior notice.
- A force gauge (sold separately) is required to use this product.
- This product is designed for force testing only. Do not use it for any other purposes.
- The sensor breaks down when apply force to bend or twist the measuring shaft.

IMADA CO., LTD

99 Jinnoshinden-cho aza Kanowari Toyohashi
Japan 441-8077
Tel: +81-(0)532-33-3288
Fax: +81-(0)532-33-3866
E-mail: info@forcegauge.net
Website: <https://www.forcegauge.net/en/>



Visit our website for more information on wide product specifications, measurement applications and videos.