

GE  
Digital Solutions

## Pressure Automated Calibration Equipment

User manual - K0470 Revision A

### PACE Indicators



© 2010 General Electric Company. All Rights Reserved. Specifications are subject to change without notice. GE is a registered trademark of General Electric Company. Other company or product names mentioned in this document may be trademarks or registered trademarks of their respective companies, which are not affiliated with GE.

## Introduction

This manual contains Installation and operating instructions for PACE Pressure Indicators.

## Safety

The manufacturer has designed this equipment to be safe when operated using the procedures detailed in this manual. Do not use this equipment for any other purpose than that stated, the protection provided by the equipment may be impaired.

This publication contains operating and safety instructions that must be followed to make sure of safe operation and to maintain the equipment in a safe condition. The safety instructions are either warnings or cautions issued to protect the user and the equipment from injury or damage.

Use qualified \* technicians and good engineering practice for all procedures in this publication.

## Pressure

Do not apply pressures greater than the maximum working pressure to the equipment.

## Toxic Materials

There are no known toxic materials used in construction of this equipment.

## Maintenance

The equipment must be maintained using the procedures in this publication. Further manufacturer's procedures should be done by an authorized service agents or the manufacturer's service departments.

## Technical Advice

For technical advice contact the manufacturer.

\* A qualified technician must have the necessary technical knowledge, documentation, special test equipment and tools to carry out the required work on this equipment.

## General Specification

Display	LCD: Colour display with touch-screen
Operating temperature	10°C to 50°C (50° to 122°F)
Storage temperature	-20°C to 70°C (-4° to 158°F)
Ingress protection	IP20 (EN60529)
Operating humidity	5% to 95% RH (non-condensing)
Vibration	MIL-PRF-28800 Type 2 class 5 style E/F
Operating altitude	Maximum 2000 metres (6560ft)
EMC	EN 61326
Electrical safety	EN 61010-1, UL61010-1, CSA 22.2, No. 61010-1 and IEC61010-1
Power adaptor	Input range: 100 - 240VAC, 50 to 60Hz, 660mA. Installation category II
Pressure safety	Pressure Equipment Directive - class: sound engineering practice (SEP) for group 2 fluids.
Pollution degree	2
Operating Environment	Indoor use only. Do <b>NOT</b> use in potentially explosive environments

## Abbreviations

The following abbreviations are used in this manual; abbreviations are the same in the singular and plural.

a	Absolute	min	Minute or minimum
a.c	Alternating current	mm	millimetre
ALT	Altitude	mV	millivolts
ASCII	American Standard Code for Information Interchange	MWP	Maximum working pressure
BSP	British pipe thread	No	Number
CAS	Calibrated airspeed	NPT	National Pipe Thread
CSK	Countersunk	PACE	Pressure automated calibration equipment
d.c.	Direct current	Para.	Paragraph
DPI	Digital Pressure Instrument	PDCR	Pressure transducer
etc.	And so on	PED	Pressure equipment directive
e.g.	For example	psi	Pounds per square inch
Fig.	Figure	PTX	Pressure transmitter
ft	Foot	ROC	Rate of climb (vertical speed)
g	Gauge	RS232	Serial communications standard
GPIB	General purpose interface bus	Rt CAS	Rate of Calibrated airspeed
Hg	Mercury	Rt MACH	Rate of MACH
Hz	Hertz	Rx	Receive data
IAS	Indicated airspeed	SCPI	Standard commands for programmable instruments
IDOS	Intelligent digital output sensor (GE product)	SDS	Sales data sheet

# PACE Pressure Indicators User Manual

---

i.e.	That is	SELV	Separated (or Safety) extra low voltage
IEEE 488	Institute of Electrical and Electronic Engineers standard 488 (for programmable devices with a digital interface)	Tx	Transmit data
in	Inch	UUT	Unit under test
kg	kilogram	V	Volts
kts	knots	+ve	Positive
m	Metre	-ve	Negative
mA	milliampere	°C	Degrees Celsius
max	Maximum	°F	Degrees Fahrenheit
mbar	Millibar		

## Related publications

K0467 User Guide and Safety Instructions

K0469 PACE Heritage Communications Manual

K0450 PACE Series Calibration Manual

K0472 PACE Series SCPI Manual

---

## Symbols



This equipment meets the requirements of all relevant European safety directives. The equipment carries the CE mark.



This symbol, on the equipment, indicates that the user should read the user manual.



This symbol, on the equipment, indicates a warning and that the user should refer to the user manual.

Ce symbole, sur l'instrument, indique que l'utilisateur doit consulter le manuel d'utilisation. Ce symbole, dans le manuel, indique une situation dangereuse.



This symbol warns the user of the danger of electric shock.

Ce symbole alerte l'utilisateur sur le danger de choc électrique.



Do not dispose of this product as household waste. Use an approved organisation that collects and/or recycles waste electrical and electronic equipment. For more information, contact one of these:

- Our customer service department: [www.gemeasurement.com](http://www.gemeasurement.com)
- Your local government office.



### WARNINGS

**TURN OFF THE SOURCE PRESSURE(S) AND CAREFULLY VENT THE PRESSURE LINES BEFORE DISCONNECTING OR CONNECTING THE PRESSURE LINES. PROCEED WITH CARE.**

**ONLY USE EQUIPMENT WITH THE CORRECT PRESSURE RATING.**

**BEFORE APPLYING PRESSURE, EXAMINE ALL FITTINGS AND EQUIPMENT FOR DAMAGE. REPLACE ALL DAMAGED FITTINGS AND EQUIPMENT. DO NOT USE ANY DAMAGED FITTINGS AND EQUIPMENT.**

**DO NOT EXCEED THE MAXIMUM WORKING PRESSURE OF THE INSTRUMENT.**

**THIS EQUIPMENT IS NOT RATED FOR OXYGEN USE.**

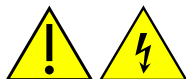

**THE GROUND LEAD OF THE INSTRUMENT MUST BE CONNECTED TO THE AC SUPPLY PROTECTIVE SAFETY GROUND.**

**ISOLATE THE POWER SUPPLY BEFORE MAKING ANY ELECTRICAL CONNECTIONS TO THE REAR PANEL.**

## Pressure units and conversion factors

Pressure units	Factor (hPa)	Pressure units	Factor (hPa)
mbar	1.0	cmH <sub>2</sub> O @ 20°C	0.978903642
bar	1000.0	mH <sub>2</sub> O @ 20°C	97.8903642
Pa (N/m <sup>2</sup> )	0.01	kg/m <sup>2</sup>	0.0980665
hPa	1.0	kg/cm <sup>2</sup>	980.665
kPa	10.0	torr	1.333223684
MPa	10000.0	atm	1013.25
mmHg @ 0°C	1.333223874	psi	68.94757293
cmHg @ 0°C	13.33223874	lb/ft <sup>2</sup>	0.4788025898
mHg @ 0°C	1333.223874	inH <sub>2</sub> O @ 4°C	2.4908891
inHg @ 0°C	33.86388640341	inH <sub>2</sub> O @ 20°C	2.486413
mmH <sub>2</sub> O @ 4°C	0.0980665	inH <sub>2</sub> O @ 60°F	2.487641558
cmH <sub>2</sub> O @ 4°C	0.980665	ftH <sub>2</sub> O @ 4°C	29.8906692
mH <sub>2</sub> O @ 4°C	98.0665	ftH <sub>2</sub> O @ 20°C	29.836983
mmH <sub>2</sub> O @ 20°C	0.097890364	ftH <sub>2</sub> O @ 60°F	29.8516987

### Unit Conversion

Convert FROM pressure VALUE 1 in pressure UNITS 1 TO pressure VALUE 2 in pressure UNITS 2, calculate as follows:

$$\text{VALUE 2} = \frac{\text{VALUE 1} \times \text{FACTOR 1}}{\text{FACTOR 2}}$$

---

## CONTENTS

<b>Section</b>	<b>Title</b>	<b>Page</b>
1	Description	1-1
1.1	Introduction	1-1
2	Installation	2-1
2.1	Packaging	2-1
2.2	Packaging for Storage and Transportation	2-1
2.3	Preparation for Use	2-1
2.4	Connecting the Instrument	2-2
2.5	Mounting kits	2-8
2.6	Electrical connections	2-10
3	OPERATION	3-1
3.1	Preparation	3-1
3.2	Power-up Sequence	3-1
3.3	Measure Mode	3-2
3.4	Operation and Example Procedures	3-8
3.5	Global Set-up Selections	3-11
3.6	Supervisor Set-up	3-12
3.7	Instrument Status	3-13
4	MAINTENANCE	4-1
4.1	Introduction	4-1
4.2	Visual inspection	4-1
4.3	Cleaning	4-1

4.4	Test	4-1
4.5	Calibration	4-1
5	TESTING AND FAULT FINDING	5-1
5.1	Introduction	5-1
5.2	Standard Serviceability Test	5-1
5.3	Ethernet testing	5-1
5.4	Fault Finding	5-4
5.5	Approved Service Agents	5-4
6	REFERENCE AND SPECIFICATION	6-1
6.1	Installation notes	6-1
6.2	Reference port	6-2
6.3	Icons	6-3
6.4	Measure Set-up	6-6
6.5	Status	6-7
6.6	Global Set-up	6-8
6.7	Supervisor Set-up	6-9
6.8	Calibration	6-27
6.9	Specification	6-27
6.10	Options	6-28
6.11	Installation and Ancillary Equipment	6-31
6.12	Return Goods/Material Procedure	6-31
6-13	Packaging Procedure	6-31



---

Intentionally blank

## 1 Description

### 1.1 Introduction

The PACE Pressure Indicator measures both pneumatic and hydraulic pressures and displays, on a colour touch-screen, the measured pressure and instrument status. The touch-screen enables selections and settings in measuring modes. The instrument can be operated remotely through communication interfaces.



**Figure 1-1 PACE1000 General view**

The rear of the instrument houses all the electrical and pressure input connections. The electrical connections provide a power supply, serial and parallel communication interfaces, pressure ports and option ports.

The instrument can be used as follows:

- Free-standing instrument positioned on a horizontal surface.
- Rack-mounted in a standard 19 inch rack using the rack-mount option kit.
- Panel mount using the panel-mount option kit.

# 1 Description

---



Options available for the PACE1000 refer to the data sheet.

Information and notes on applications (Ref: Reference and Specification, Section 6) or [www.gemeasurement.com](http://www.gemeasurement.com)

## 2 Installation

### 2.1 Packaging

Check the contents of the PACE1000 packaging with the list that follows:

#### **Packaging List - PACE1000**

- i) PACE1000 Pressure Indicator.
- ii) Adaptor, power supply (GE part number 191-370).
- iii) User guide and safety instructions, and CD containing the full documentation suite.
- iv) Calibration certificate.

### 2.2 Packaging for Storage or Transportation

To store or return the instrument for calibration/repair do the procedures that follow:

1. Pack the instrument (Ref: Reference and Specification, Section 6.13).
2. Return the instrument for calibration/repair complete the return goods procedure (Ref: Reference and Specification, Section 6.12).

### 2.3 Preparation for Use

The instrument can be used as a:

- Free-standing instrument positioned on a horizontal surface.
- Panel-mounted using the panel-mount option kit (Ref: Section 2.5).
- Rack-mounted in a standard 19 inch rack using the rack-mount option kit (Ref: Section 2.5).

For free-standing instruments, the feet on the front of the base can be used elevate the instrument to a better viewing angle.

**Note:** *Allow a free flow of air around the instrument, especially at high ambient temperatures.*

## 2 Installation

### 2.4 Connecting the Instrument



#### WARNINGS

TURN OFF THE SOURCE PRESSURE(S) AND CAREFULLY VENT THE PRESSURE LINES BEFORE DISCONNECTING OR CONNECTING THE PRESSURE LINES. PROCEED WITH CARE.

ONLY USE EQUIPMENT WITH THE CORRECT PRESSURE RATING.

BEFORE APPLYING PRESSURE, EXAMINE ALL FITTINGS AND EQUIPMENT FOR DAMAGE. REPLACE ALL DAMAGED FITTINGS AND EQUIPMENT. DO NOT USE ANY DAMAGED FITTINGS AND EQUIPMENT.

DO NOT EXCEED THE MAXIMUM WORKING PRESSURE OF THE INSTRUMENT.

THIS EQUIPMENT IS NOT RATED FOR OXYGEN USE.

#### Pneumatic Pressure (Figure 2-1)

1. Refer to the Data sheet for the correct pressure mediums to be used.
2. Connect the Unit Under Test (UUT) to the required connection port.

**Note:** For instruments with NPT connections, use applicable bonded sealing as shown in figure below.

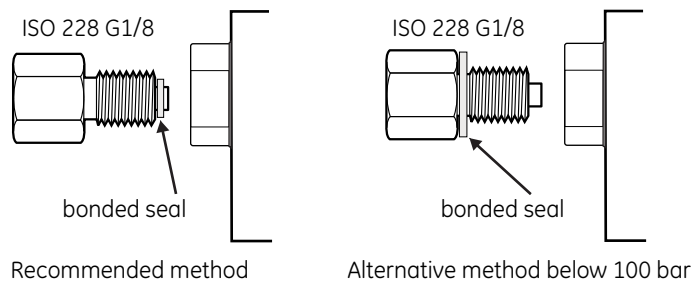

**Figure 2-1, Sealing Pneumatic Connections**

## Pneumatic connections



### WARNING

**PARALLEL THREADS MUST BE USED. FEMALE THREAD TYPE IS PARALLEL THREAD TO ISO228/1 (DIN ISO228/1, JIS B0202) G1/8.**

**TAPERED THREADS NOT ALLOWED.**

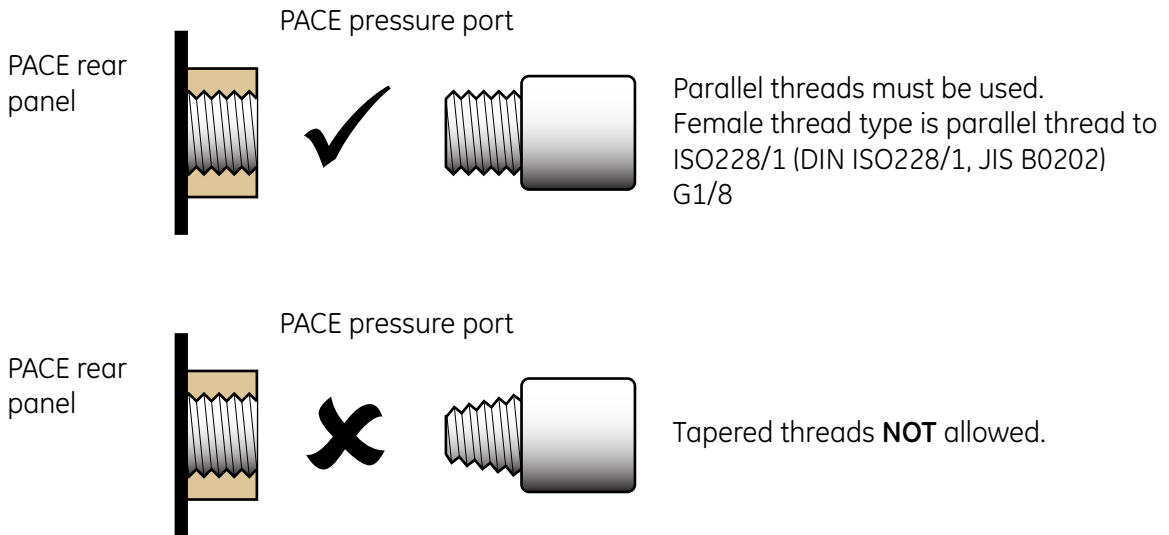

Connection	
Input	ISO228/1 G 1/8 parallel threads (DIN ISO228/1, JIS B0202)
Reference	ISO228/1 G 1/8 parallel threads (DIN ISO228/1, JIS B0202)

*For examples of adaptors (Ref: page 2 - 4).*

### Input Pressure (Figure 2)

1. Make sure the user systems can be isolated and vented.
2. Connect the Unit Under Test (UUT) to the output connection port.

**Note:** *For instruments with NPT connections, use applicable bonded sealing as shown in figure below.*

## 2 Installation

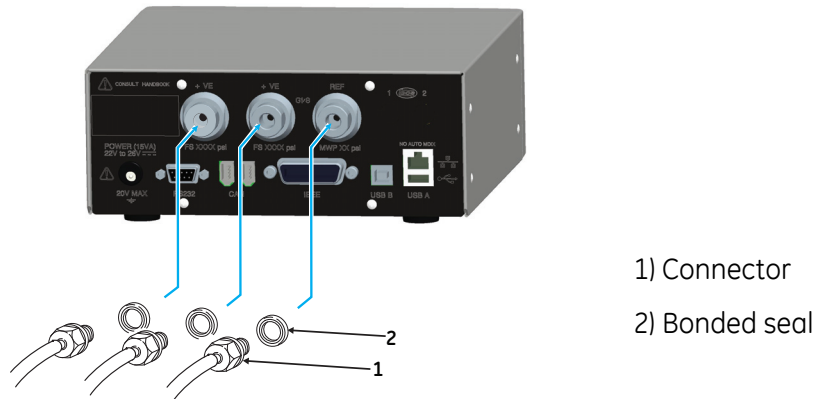

Figure 2-2, Pneumatic Connections

### Installation

The instrument connects to the Unit Under Test.

### Input Pressure and Equipment

The pressure should not exceed 1.25 x full-scale or MWP stated on the rear panel of the instrument.

To protect the instrument from over-pressure a suitable protection device (such as a relief valve or bursting disc) must be fitted to prevent over pressurization.

### Pneumatic Connection



#### WARNING

**PRESSURE RANGES > 210 BAR (3000 PSI) ARE ONLY RATED FOR HYDRAULIC USE.**

#### CAUTIONS

**Do not exceed the maximum pressures stated in the appropriate Component Manual for the unit under test.**

**Reduce pressure at a controlled rate when venting to atmosphere.**

**Carefully de-pressurize all pipes to atmospheric pressure before disconnecting and connecting to the unit under test.**

### Connections

1. Switch off the power supply before connecting or disconnecting the instrument.
2. Use the appropriate sealing method for all pressure connections.

**Note:** For instruments with NPT connections, use applicable bonded sealing as shown in figure below.

## Method of connection

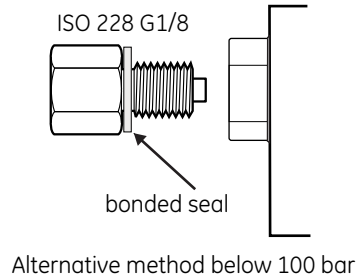
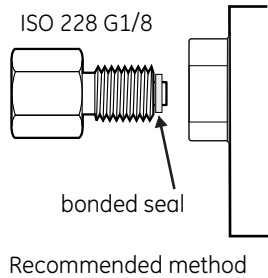

## Adaptors

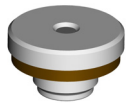

IO-SNUBBER-1

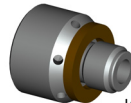

IO-DIFFUSER-1

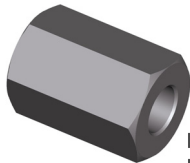

IO-ADAPT-9/16AUTOC  
ISO 228 Male to 9/16 Autoclave

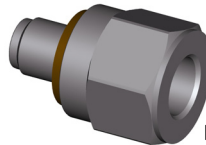

IO-ADAPT-7/16UNF  
ISO 228 Male to 7/16 UNF Female

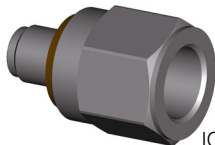

IO-ADAPT-G1/4  
ISO 228 Male to G1/4 Female

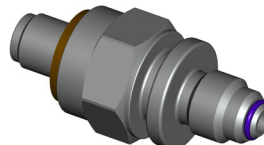

IO-ADAPT-AN4  
ISO 228 Male to AN4 37° Male

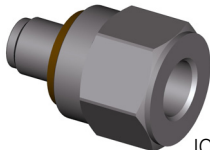

IO-ADAPT-1/8NPT  
ISO 228 Male to 1/8 NPT Female

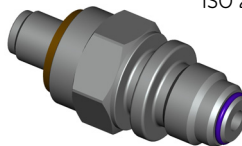

IO-ADAPT-AN6  
ISO 228 Male to AN6 37° Male

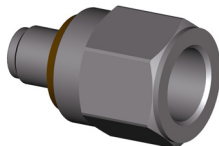

IO-ADAPT-1/4NPT  
ISO 228 Male to 1/4 NPT Female

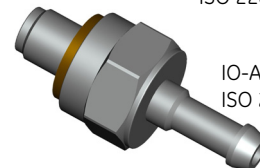

IO-ADAPT-BARB  
ISO 228 Male to 1/4 Hose

Refer to the data sheet for the range of adaptors.



## 2 Installation

---

### Hydraulic Pressure



#### WARNINGS

HYDRAULIC LIQUID IS DANGEROUS. OBSERVE RELEVANT HEALTH AND SAFETY PRECAUTIONS. USE APPROPRIATE PROTECTIVE BARRIERS AND EYE PROTECTION.

BEFORE APPLYING PRESSURE, EXAMINE ALL FITTINGS AND EQUIPMENT FOR DAMAGE AND ENSURE THAT ALL EQUIPMENT IS TO THE CORRECT PRESSURE RATING.

DO NOT EXCEED THE MAXIMUM WORKING PRESSURE OF THE INSTRUMENT.

PURGE ALL AIR FROM THE HYDRAULIC LIQUID.

PRESSURE RANGES > 210 BAR (3000 PSI) ARE ONLY RATED FOR HYDRAULIC USE.

DO NOT USE A SENSOR FOR GAS THAT HAS BEEN USED WITH HYDRAULIC LIQUID.

#### CAUTIONS

Do not exceed the maximum pressures stated in the appropriate component manual for the unit under test.

Reduce pressure at a controlled rate when venting to atmosphere.

Carefully de-pressurize all pipes to atmospheric pressure before disconnecting and connecting to the unit under test.

Observe absolute cleanliness when using the instrument.

Severe damage can be caused if equipment connected to this instrument is contaminated.

Connect only clean equipment to the instrument.

To avoid any contamination, an external filter is recommended.

## Installation

The instrument connects to the Unit Under Test.

### Input Pressure and Equipment

1. The pressure should not exceed  $1.25 \times$  full-scale or MWP stated on the rear panel of the instrument.
2. To protect the instrument from over-pressure a suitable protection device (such as a relief valve or bursting disc) must be fitted to limit the pressure to below the MWP.

**Note:** For instruments with NPT connections, use applicable bonded sealing as shown in figure below.

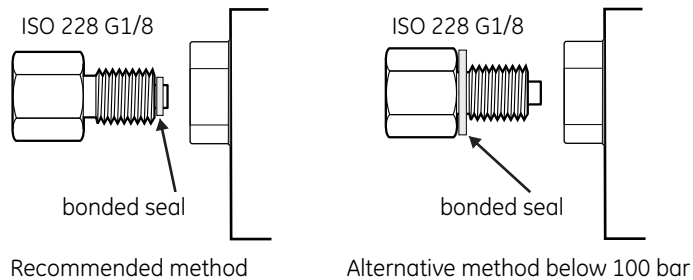

**Figure 2-3, Sealing Hydraulic Connections**

### Hydraulic connections

Connection	
Input	ISO228/1 G 1/8 parallel threads (DIN ISO228/1, JIS B0202)
Reference	ISO228/1 G 1/8 parallel threads (DIN ISO228/1, JIS B0202)

**Note:** Pressure connections greater than 210 bar are 9/16" 18UNF Male Autoclave.

1. Switch off the power supply before connecting or disconnecting the instrument.
2. Use the applicable sealing method for all pressure connections.
3. Isolate the hydraulic pressures and de-pressurise the pipes before connecting or disconnecting the instrument.

### Pressure input (Figure 2)

1. Make sure the user systems can be isolated and vented.
2. Use the applicable sealing method for all pressure connections.
3. The hydraulic liquid must be clean, refer to specification given in the Data sheet.
4. Connect the Unit Under Test (UUT) to the appropriate connection port.
5. Fill and bleed the UUT and connecting pipes.

## 2 Installation

### 2.5 Mounting kits

#### Rack-mount option (Figure 2-5)

There must be enough space at the rear of the instrument for all the cables and pipes. The length of the cables and pipes must allow for the removal and installation of the instrument. The cooling air of the instrument must not be obstructed. Allow a free flow of air through the equipment rack and around the instrument, especially at high ambient temperatures.

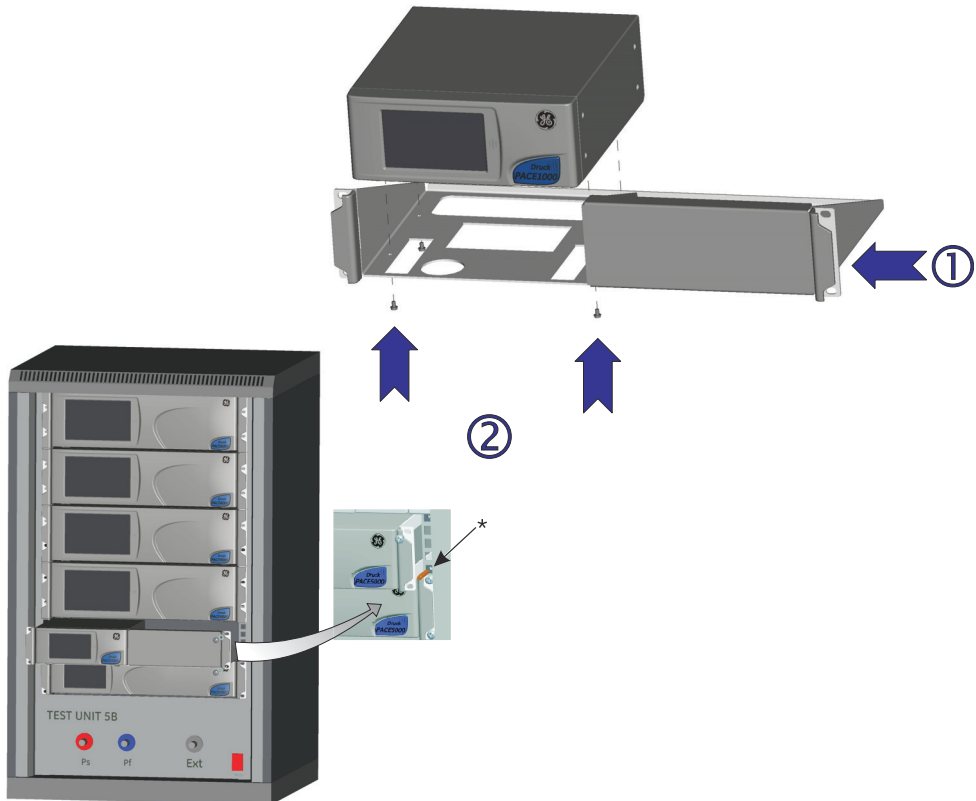

Figure 2-5 Rack-mounting

#### Procedure

1. Locate instrument in rack mount assembly ①.
2. Secure with the four M3 x 6 screws ②, (maximum length M3 x 8).
3. Support the instrument and connect the cables and pipes.
4. Refer to the electrical connections below before fitting the instrument into the equipment rack.
5. Temporarily locate the two spigots\* to each side of the equipment rack.
6. Locate and slide the instrument into the rack.
7. Locate the instrument on the spigots\*.

8. Secure the instrument in the equipment rack with two of the screws and washers (supplied).
9. Remove the two spigots\* and replace with the remaining two screws and washers (supplied).

### Panel-mount option (Figure 2-6)

There must be enough space at the rear of the instrument for all the cables and pipes. The length of the cables and pipes must allow for the removal and fitment of the instrument. The cooling air of the instrument must not be obstructed.

Allow a free flow of air through the equipment rack and around the instrument, especially at high ambient temperatures.

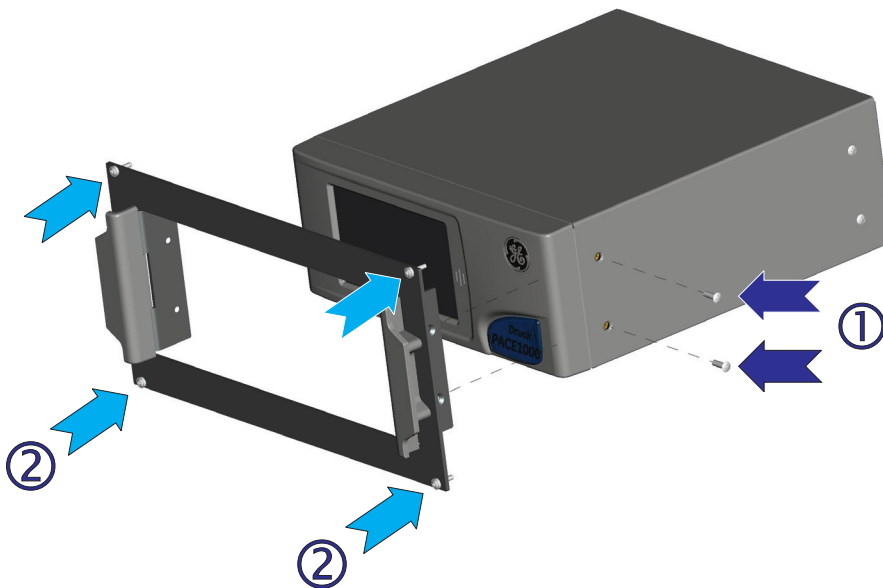

Figure 2-6 Panel-mounting

### Procedure

1. Remove the four screws ① from the instrument.
2. Locate the instrument in panel mount assembly.
3. Secure with the four screws ①.
4. Support the instrument and connect the cables and pipes.
5. Refer to the electrical connections below before fitting the instrument into the panel.
6. Secure the instrument in the panel with four screws and washers ②.

## 2 Installation

### 2.6 Electrical connections

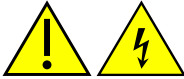

#### WARNINGS

**THE GROUND LEAD OF THE INSTRUMENT MUST BE CONNECTED TO THE AC SUPPLY PROTECTIVE SAFETY GROUND.**

**ISOLATE THE POWER SUPPLY BEFORE MAKING ANY ELECTRICAL CONNECTIONS TO THE REAR PANEL.**

#### CAUTIONS

**Use the power adaptor supplied with the instrument (GE part no. 191-370). Using other power adaptors may cause over-heating, this can result in a fire.**

**Do not let the power adaptor come into contact with any moisture or liquids.**

#### Connecting (Figure 2-7)

1. Before use, make sure the SELV power adaptor supplied with the instrument is used (GE part number 191-370).
2. Install an accessible power isolator to use as the disconnecting device in the power adaptor supply circuit.
3. The power adaptor input power supply range: 100 - 240VAC, 50 to 60Hz 660mA, Installation Category II.

**Note:** *The power adaptor must be supplied by a fused or overload-protected power supply.*

4. Connect the power adaptor to the instrument.
5. Switch the power supply on.
6. Check that the front panel display shows the power-up sequence (Ref: section 3.2).

**Note:** *After the power-up sequence, the instrument shows the default display on the touch screen. The touch screen divides into a number of mimic keys.*

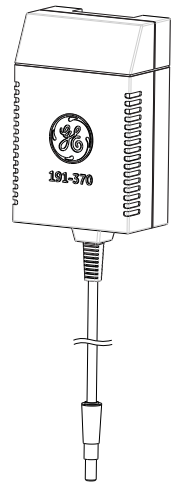

#### Requirements for rack-mounted and panel-mounted instruments

1. Install an accessible power isolator to use as the disconnecting device in the power adaptor supply circuit.
2. Set the power supply isolator to OFF.
3. Connect the power adaptor before sliding the instrument into the rack.
4. Set the power supply isolator to ON.
5. Check that the front panel display shows the power-up sequence (Ref: section 3.2).

## Communication Connections

Connect the applicable connectors into the rear panel communications ports and, if appropriate, secure with the captive screws.

**Note:** The RS232 and IEEE 488 interfaces are both enabled at power-up. Set the required parameters in Supervisor Setup/communications menu, see Section 3.6.

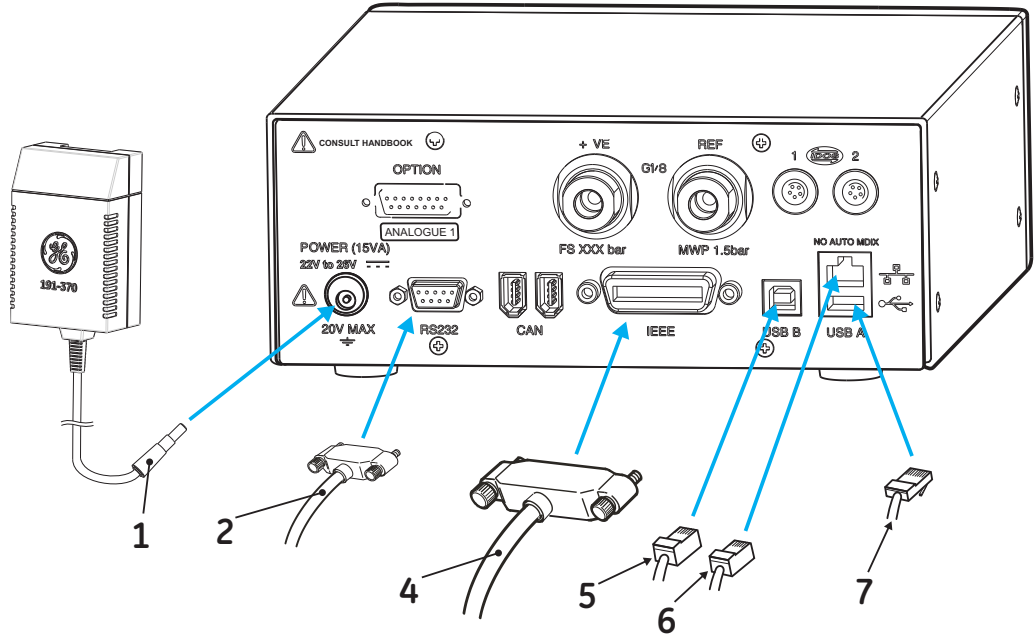

**Figure 2-7, Communication Connectors**

- |   |                      |   |       |   |          |
|---|----------------------|---|-------|---|----------|
| 1 | Power supply adaptor | 2 | RS232 | 4 | IEEE488  |
| 5 | USB B                | 6 | USB A | 7 | Ethernet |

## RS232 Interface

When using the RS232 interface, a cable must be connected directly from the instrument to a suitable port on the computer in a 'point to point' link.

The pin connections for the 9-pin D-type, RS232 connector and the relationship between the instrument and the RS232 control signals, together with device interconnection interface is shown in Table 2-1. The instrument is configured as Data Circuit Terminating Equipment (DCE).

## 2 Installation

Instrument		Control Line		Computer/Printer	
Instrument Function	Connector 9-way D-type Pin No.	Signal Direction	RS232 Terminology	Connector Type	
				9-way D-type Pin No.	25-way D-type Pin No.
RxD (I/P)	3	←	TxD	3	2
TxD (O/P)	2	→	RxD	2	3
GND	5	↔	GND	5	7
CTS (I/P)	7	←	RTS	7	4
RTS (O/P)	8	→	CTS	8	5
Pulled high internally	1	→	RLSD (DCD)	1	8
Not connected	4	←	DTR	4	20
Pulled high internally	6	↔	DSR DCE Ready	6	6
Equipment chassis	Connector shell	↔	Cable Screen	-	1

**Table 2-1, RS232 Connections**

### Handshaking connections

Software handshaking use: TXD, RXD and GND.

Hardware handshaking use: TXD, RXD, GND, CTS, RTS and DTR.

## IEEE 488 Interface

The interface complies with IEEE 488 standard.

The IEEE 488 parallel interface connects a computer/controller to one or more PACE1000 instruments and other instruments.

Up to 30 instruments can be connected through a high-speed data bus to the computer/controller.

**Note:** *The length of each IEEE 488 cable must be less than 3 metres to comply with the EMC requirements (Ref: Data sheet).*

### Single Unit Installation (Figure 2-8)

1. Connect an IEEE 488 connector/cable assembly to the rear panel of the instrument.
2. Connect the other end of the connector/cable assembly to the IEEE 488 connector on the controller/computer.
3. Change the IEEE 488 communication parameters (Ref: Supervisor set-up, Section 6.7).

### Multiple Unit Installation (Figure 2-8)

To install multiple units use stacking plugs to link the first instrument and second instrument as follows:

1. Connector to rear panel of first instrument (Ref Illustration).
2. Connector from controller/computer (Ref Illustration).
3. Connector to rear panel of second instrument (Ref Illustration).
4. Connect the IEEE 488 connector on the controller/computer and the other connector into the next instrument.
5. Repeat this procedure for all the instruments in the system.
6. Use the Supervisor set-up (communications) menu on each instrument to set-up the required communication parameters (Ref: Section 3.8).

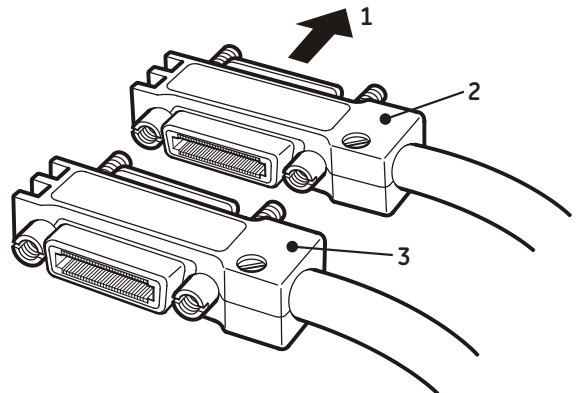



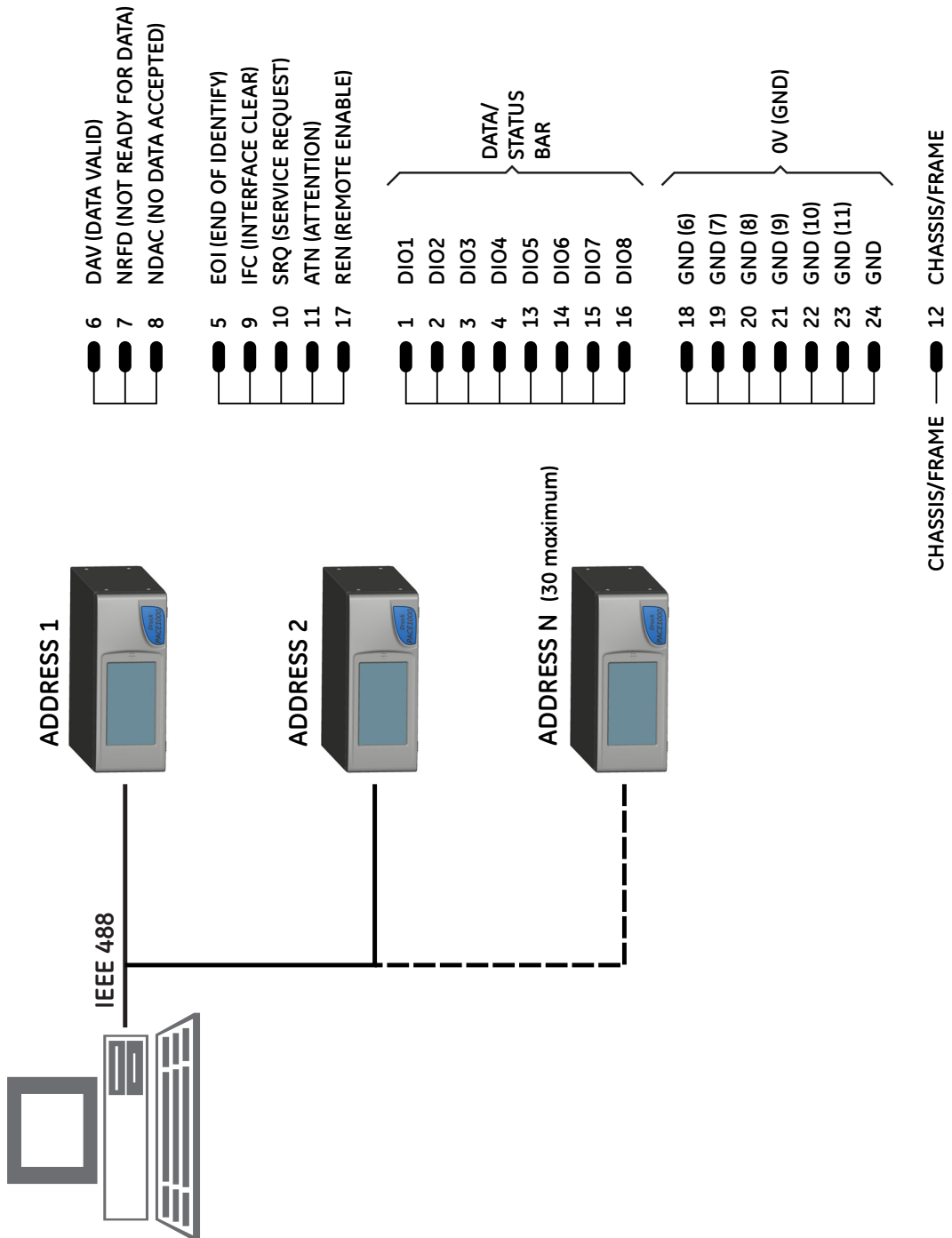

Figure 2-8 - IEEE 488 Connection

## 3 Operation

This section contains quick reference charts detailing all the available functions and the set-up menu.

### 3.1 Preparation

Make sure the electrical cables and pneumatic pipes comply with the installation requirements (Ref: Section 2).

Before use do the following:

1. If necessary, do the maintenance task (Ref: Section 4).
2. For bench-top, single instrument operation do the following:
  - a. Connect the instrument to the electrical supply.
  - b. Inspect the pneumatic hoses for damage, ingress of dirt and moisture.
3. Before use, the instrument should be tested.
4. Review and become familiar with the procedure before starting a process on a component or system.

### 3.2 Power-up sequence

The following sequences of operation shows the instrument display.

**Note:** *The following sequence is an example, the values and selections displayed depend on the range(s) and options enabled in the instrument.*

1. Set the power supply to ON.
2. The display shows the power-up sequence.
3. The instrument carries out a self-test.
  - a. If the test finds a fault, the display shows an error (Ref: Fault Finding and Testing, Section 5).
4. If the self-test is successful the system enables the touch screen and changes to measure mode.
5. The touch screen shows the measured pressure in the parameters selected in set-up.
6. The instrument is now ready for use.

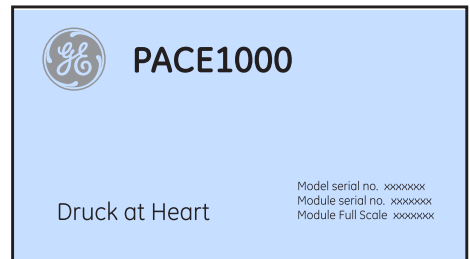

*Do not touch the display screen during power-up*

## 3 Operation



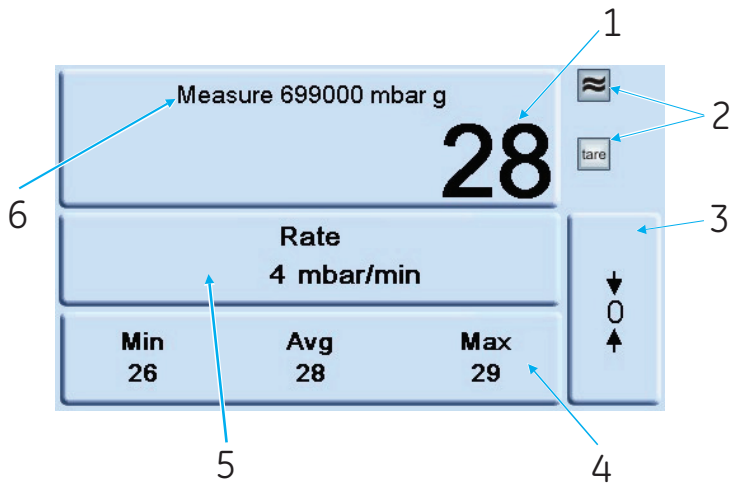

### 3.3 Measure mode



#### Touch screen areas

- 1 Pressure reading    2 Functions enabled    3 Zero key (vent system before starting zero sequence)  
 4 Function area    5 Status area    6 Current pressure range

#### Display Icons

	Tare enabled		Filter pressure reading
	Percentage		Ethernet not connected
	Reference level difference (gas head correction)		Ethernet connected

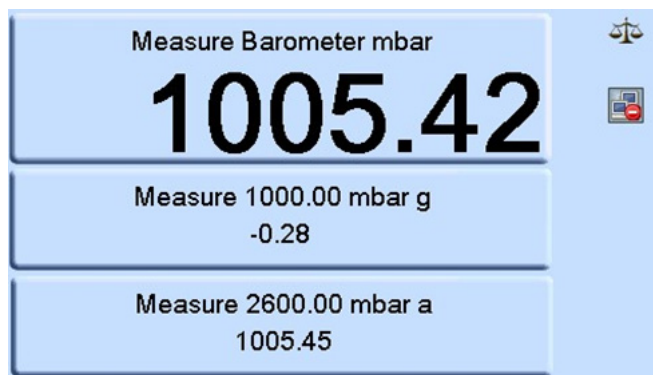



Function area Min/Avg/Max is performed on the reading selected for display in the top screen.

The Ethernet LAN Status indication (1) shows the following:

- Colour red - not connected
- Colour green - connected

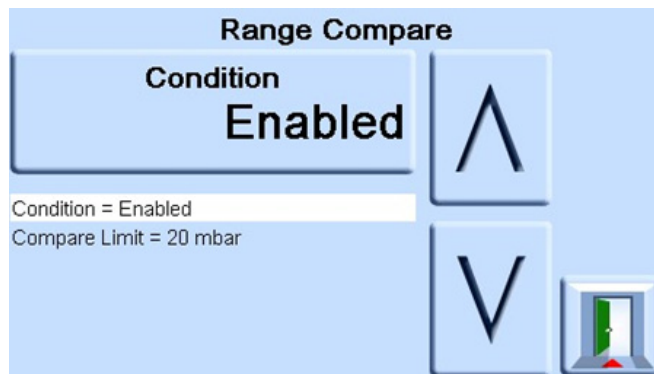
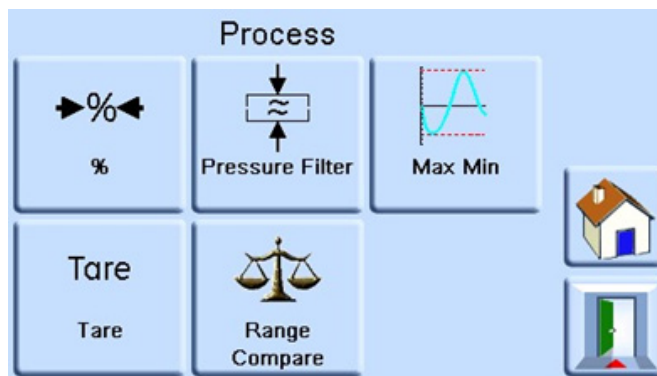

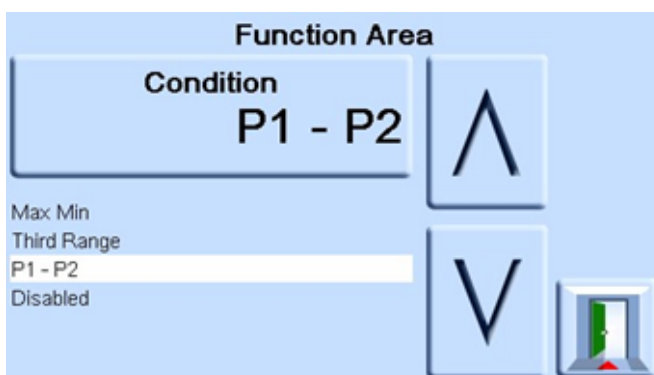
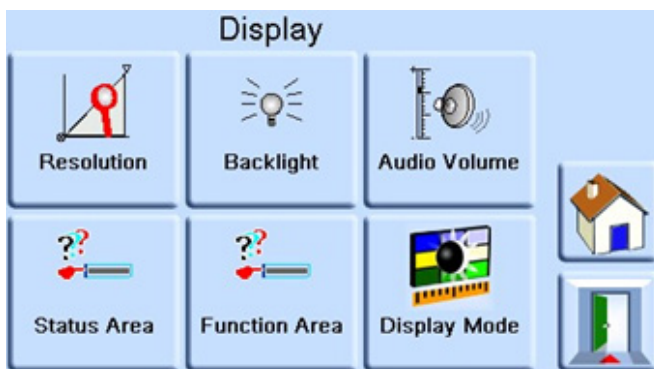

#### Data Logging

The "Datalog" icon (1) is present when a memory card is fitted:

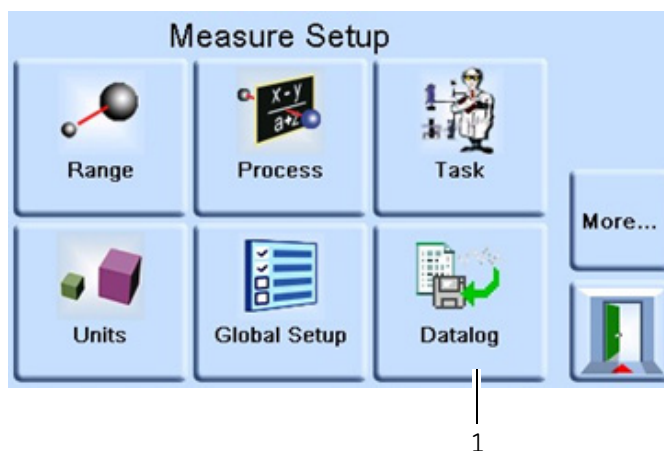

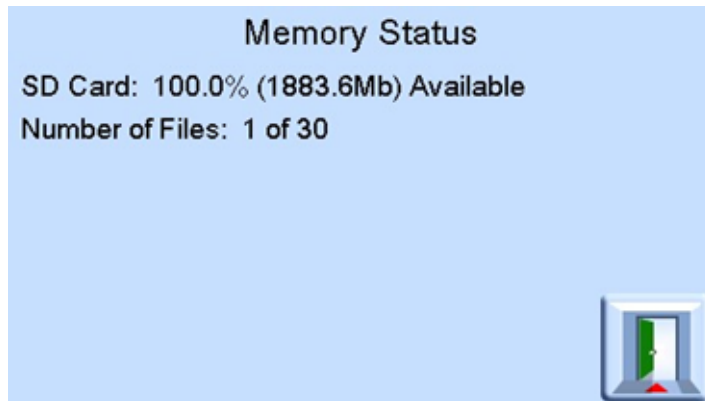
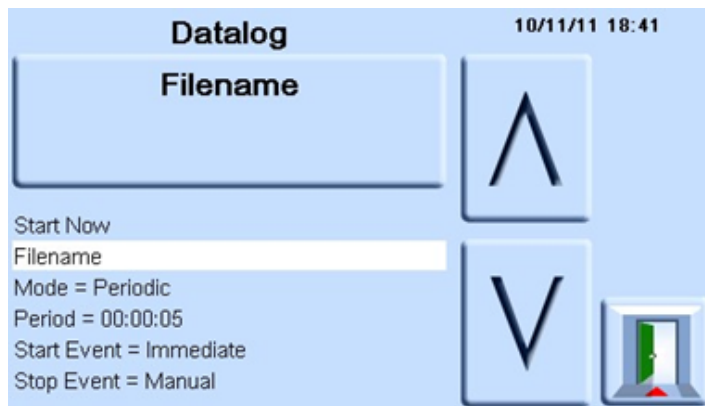
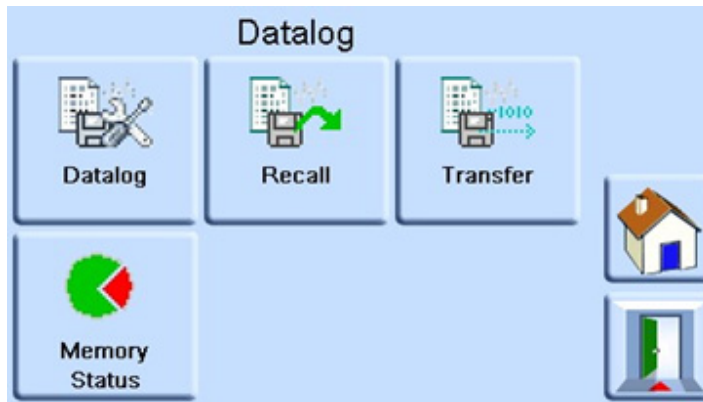

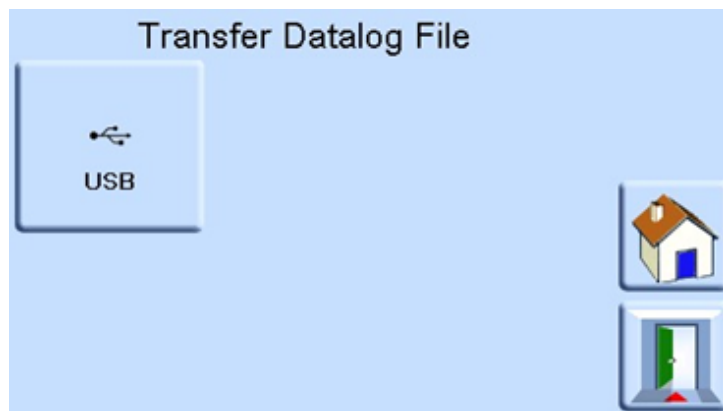
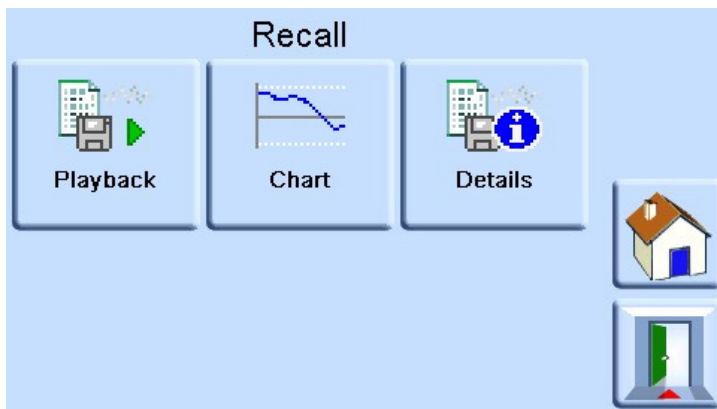
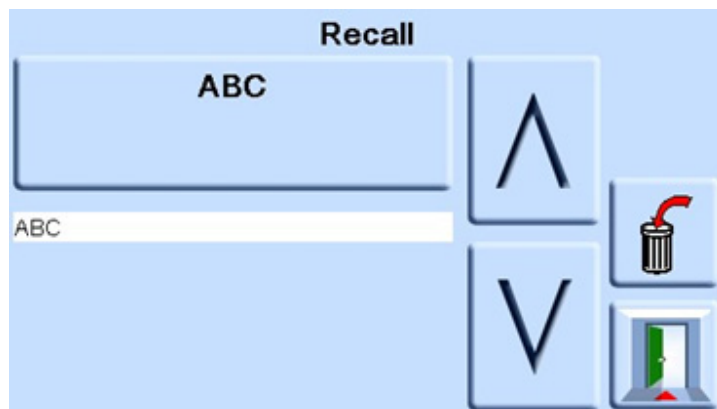

## Measure Menu Set-up

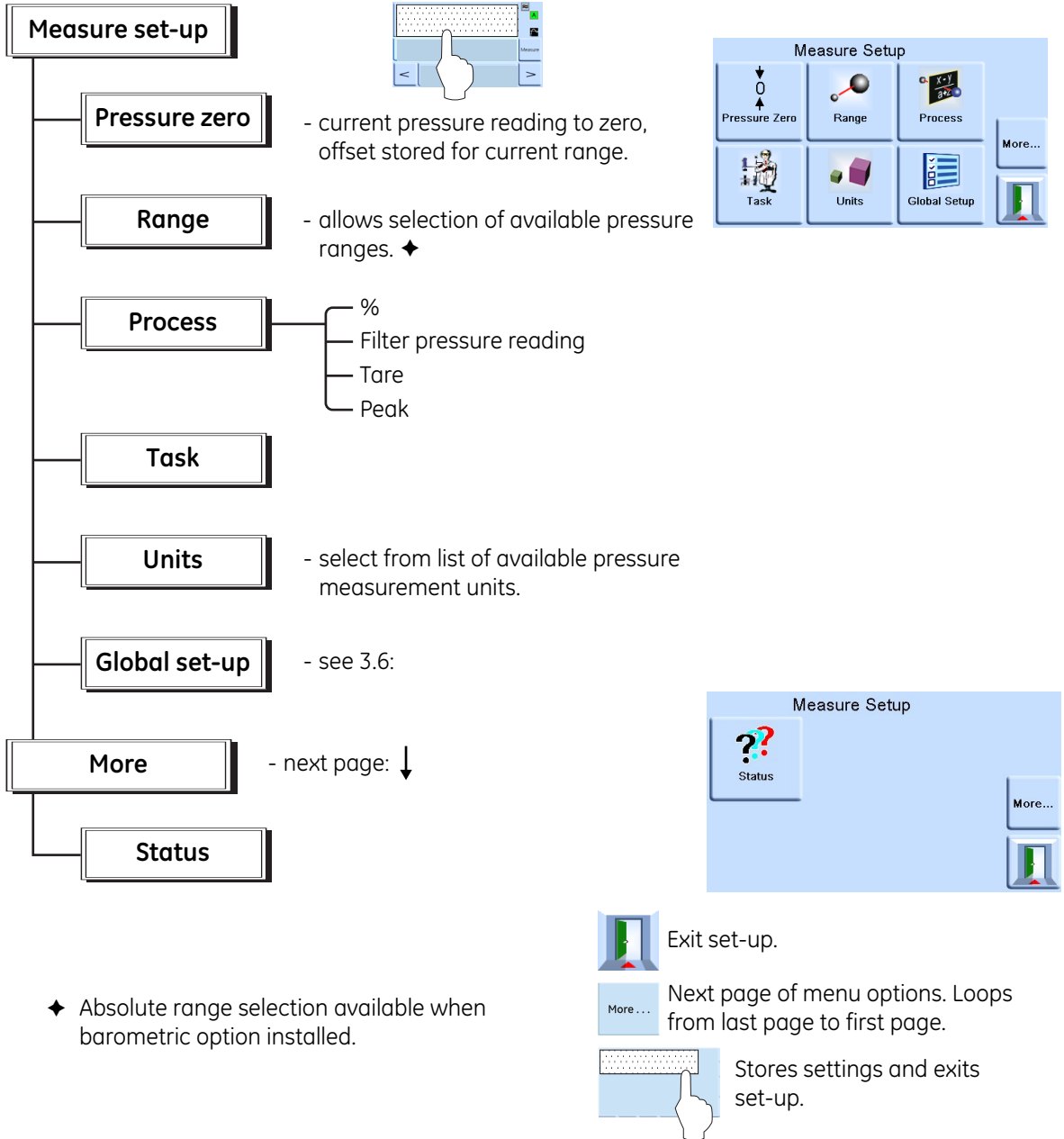



## 3 Operation

### 3.4 Operation and Example Procedures

#### Introduction

Before operation, the instrument must be connected to the correct electrical and pneumatic/ hydraulic) supplies, (Ref: Installation, Section 2).

When the instrument is switched ON the display shows measured pressure mode and the task set before the power-off.

#### Measure Mode

The instrument works as a precision pressure indicator and shows the pressure measured at the output port.

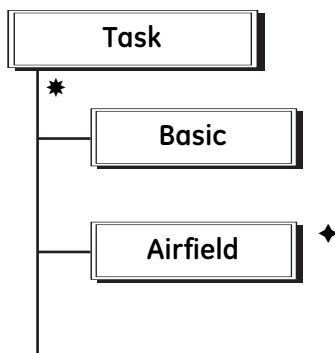

Pressing **Task** enables pre-determined functions:

#### Task

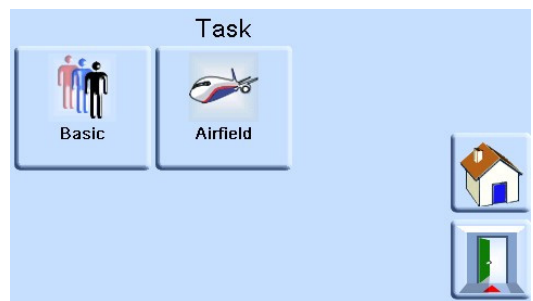

- ◆ Option refer to data sheet
- \* Selecting a task exits the menu and changes the display to the task selected.



-  Return to home.
-  Exit set-up.

The display shows the task screen (Ref: Illustration above).

When selected, e.g. Basic, the screen changes to show the selected task.

To measure pressure in the task proceed as follows:

1. Select the required units of pressure measurement from the measure set-up menu.

## PACE Pressure Indicators User Manual

**Note:** In the Airfield Task Q codes can be used. These units are standardised three letter codes and are available in aeronautical units (feet and metres). The codes used are:

- QFE - Atmospheric pressure at sea level, corrected for temperature and adjusted to airfield elevation. When set on the altimeter it reads height.
- QNE - Atmospheric pressure at Sea level in International Standard Atmosphere (ISA) 1013.25 mbar.
- QFF - Barometric pressure at a place, reduced to Mean Sea Level (MSL) using the actual temperature at time of observation as mean temperature.
- QNH - Atmospheric pressure at Mean Sea Level (MSL) (may be local, measured pressure or a Regional Forecast Pressure (RFP). When set on altimeter it reads altitude.

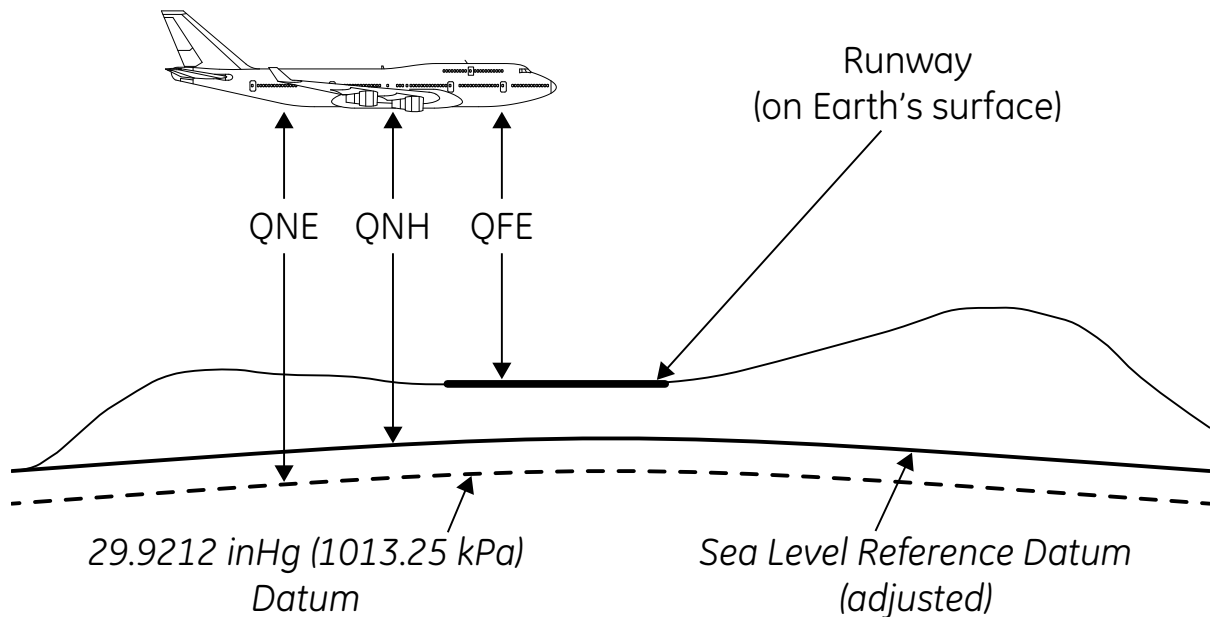

### 3 Operation

#### Leak testing option

This task, measures the leak rate over the measure dwell time.

At the start of the test, the instrument measures the test pressure of the user system. The instrument then records the pressure change during measure dwell time.

On completion, the display shows the leak rate results with leak rate per second or per minute in the current pressure units selected in measure set-up.

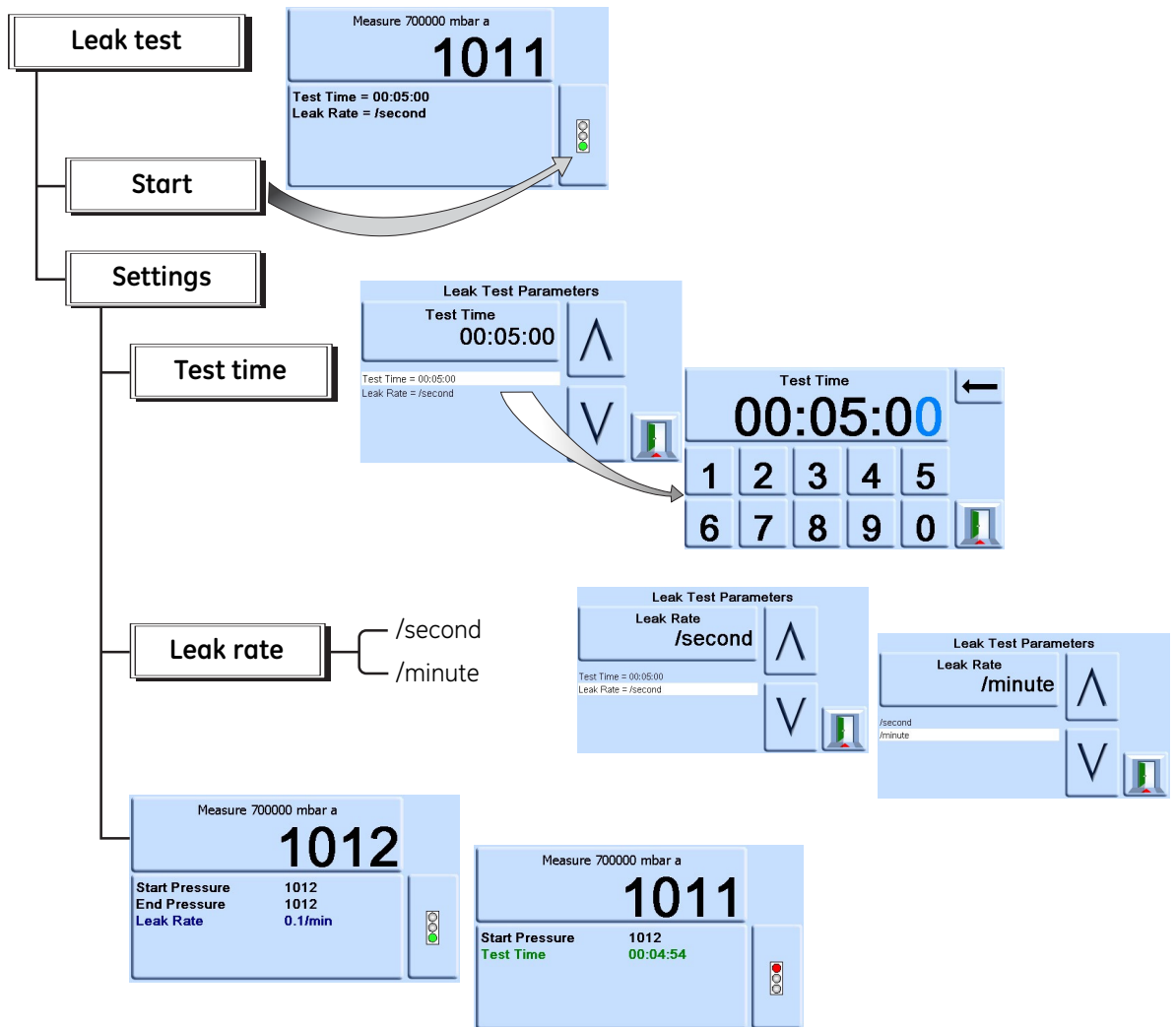

## 3.5 Global Set-up Selections

Global set-up selections provide access to the instrument's settings for both measure and control modes.

This set-up menu provides PIN-protected access to the supervisor set-up and calibration. Pressing Global Set-up changes the touch-screen display to show available selections.

**Supervisor Set-up, Calibration, Save/Recall User Set-up and Display.**

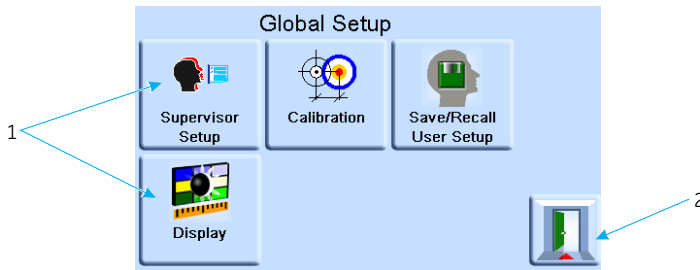

1 Selections      2 Escape Key

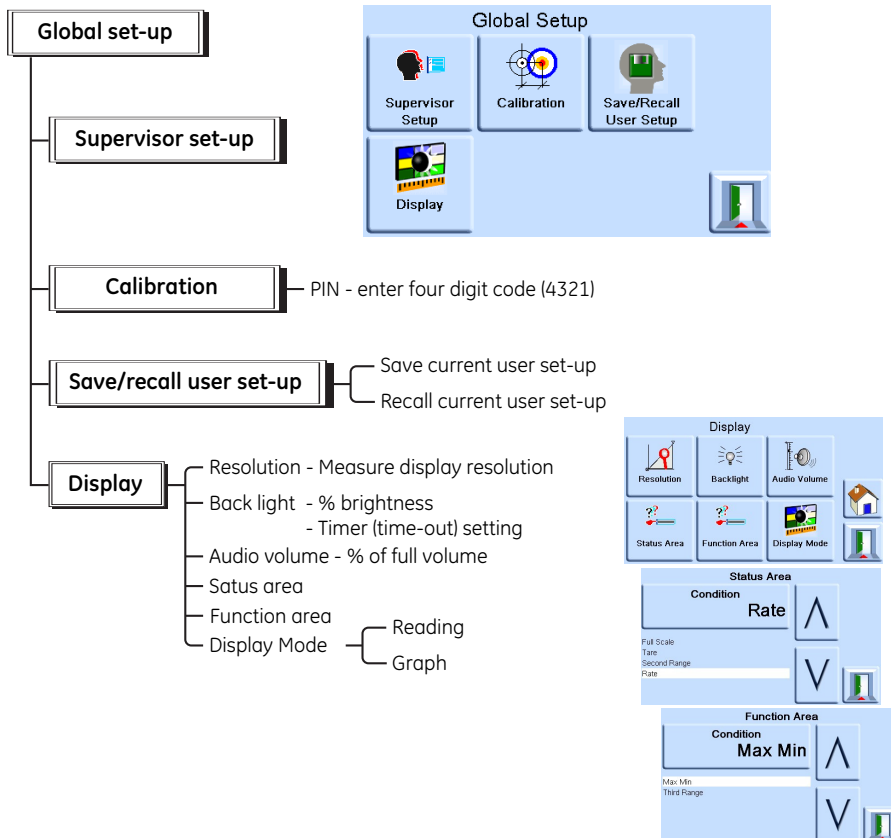

# 3 Operation

## 3.6 Supervisor Set-up

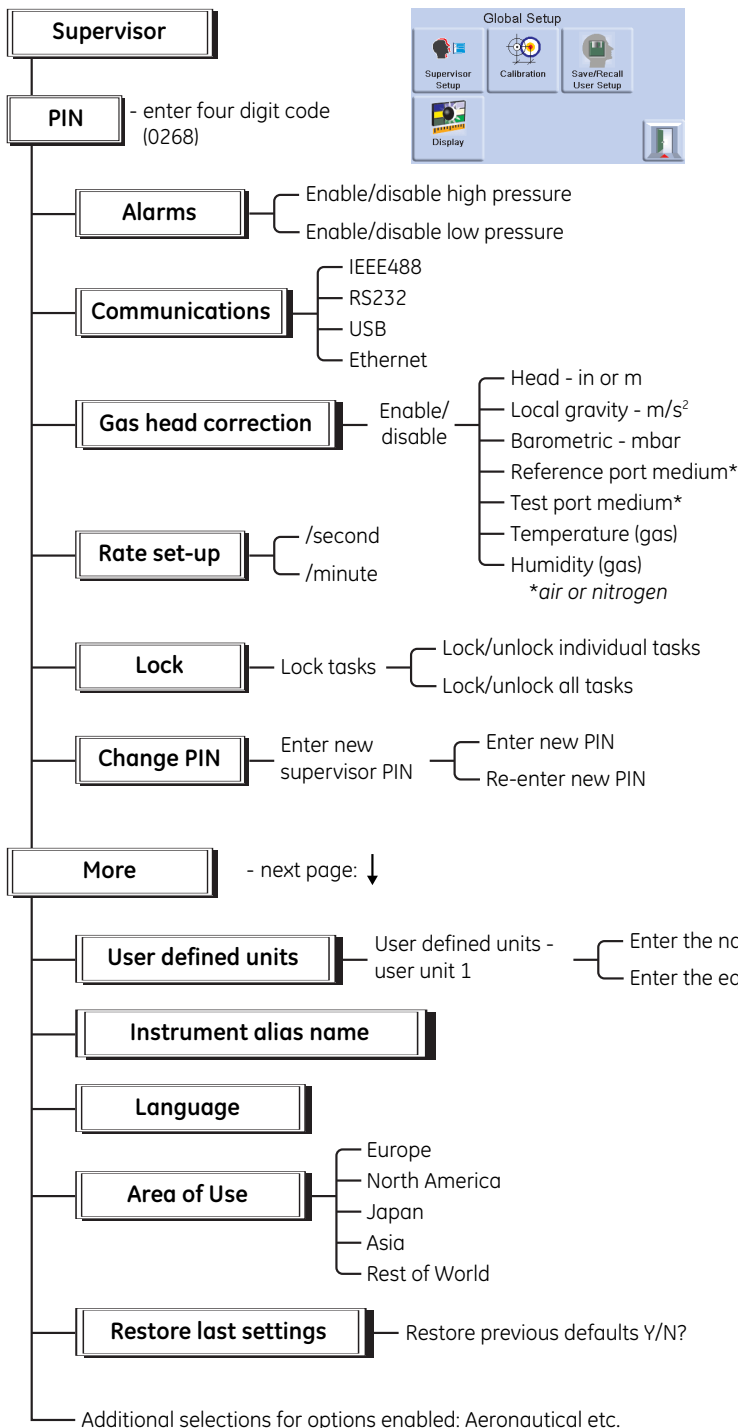

Pressing the escape key stores settings and returns to global set-up.

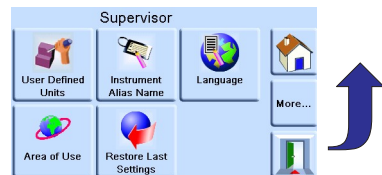
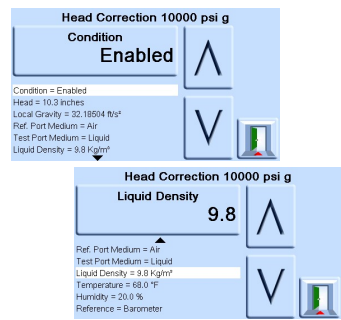
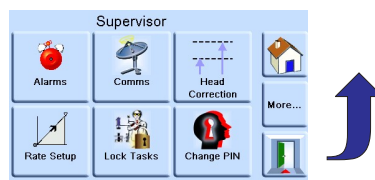

## 3.7 Instrument Status

The control set-up menu provides access to the status of the instrument:

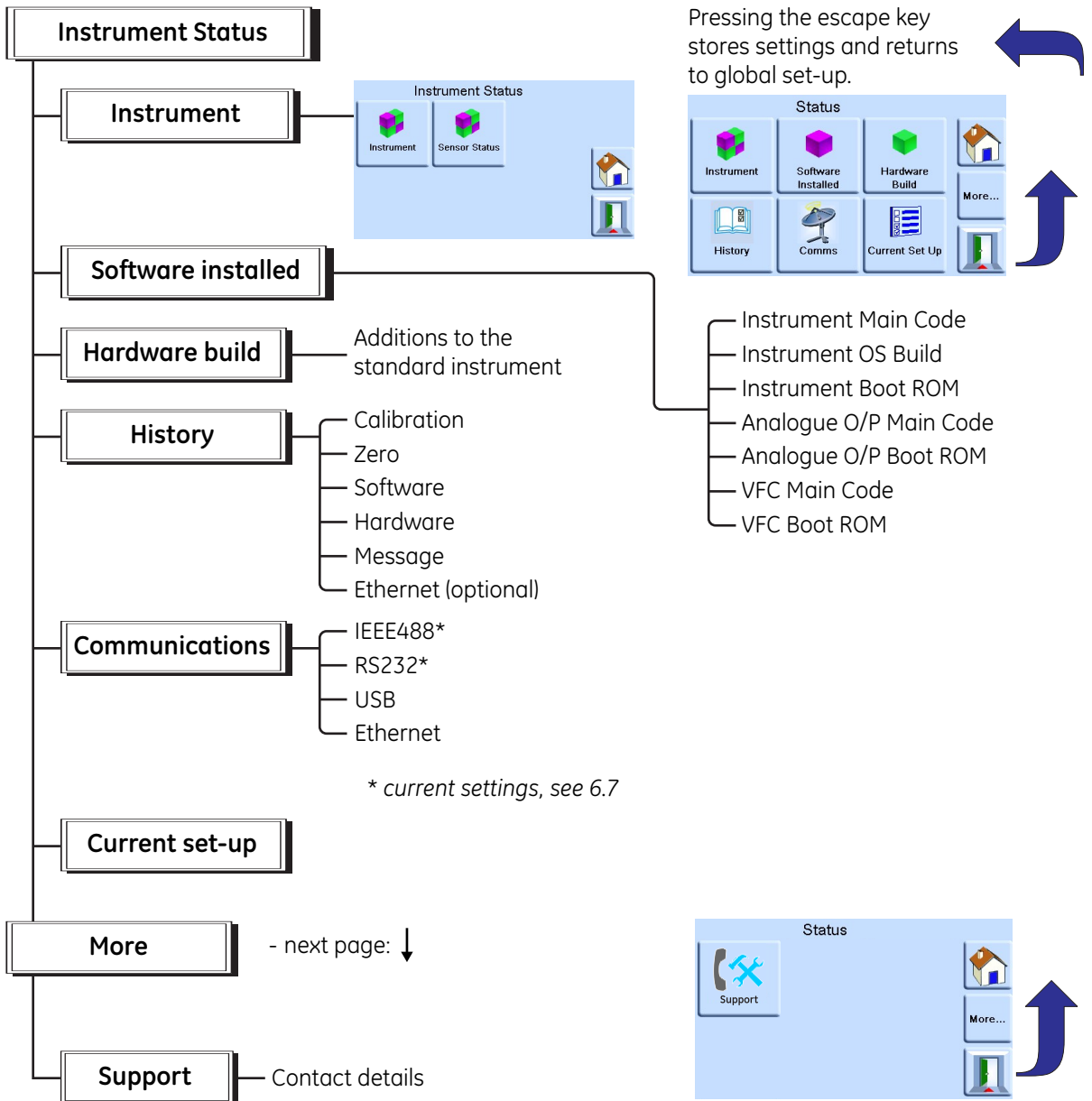

### 3 Operation

#### Software

Software history, in the status menu, provides read only information on the current software in the instrument.

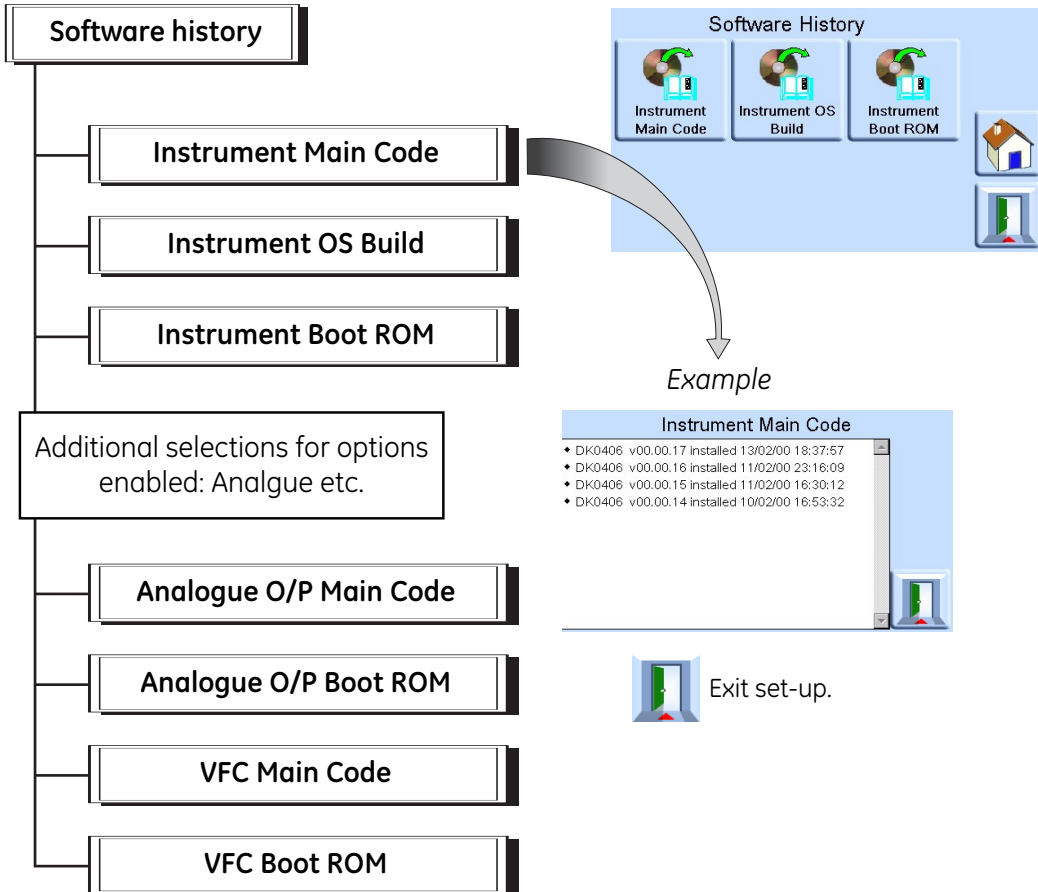

## 4 Maintenance

### 4.1 Introduction

This section contains procedures for routine maintenance and the replacement of components (Ref: Testing and Fault Finding, Section 5).

**Table 4.1 - Maintenance Tasks**

Task	Period
Visual Inspection	Before use
Test	Before use
Cleaning	Weekly*
Calibration	12 months †

\* may change depends on usage (e.g., rack mounted, bench top) and environment (e.g., humidity, dust).

† may change depends on the required accuracy.

### 4.2 Visual Inspection

Inspect for obvious signs of damage and dirt on the following:

- a. External of the instrument.
- b. Power supply adaptor
- c. Associated equipment.

Damaged parts must be replaced contact GE Service.

For cleaning (Ref: Cleaning Section 4.3).

### 4.3 Cleaning



#### **CAUTION**

**Do not use solvents for cleaning.**

Clean the front panel with a damp lint-free cloth and mild detergent.

### 4.4 Test

Do a standard serviceability test (Ref: Standard Serviceability Test, Section 5.2).

### 4.5 Calibration

The instrument should be returned to the manufacturer or calibration facility, (Ref: Section 6.14).

To find the date of the last calibration, press Measure set-up/Status/Calibration history.



Intentionally blank

## 5 Testing and Fault Finding

### 5.1 Introduction

This section details the standard serviceability test. Table 5.1 lists possible faults, and the response.

The PACE1000 contains a self-test and diagnosis system that continuously monitors the performance of the unit. At power-up, the system performs a self-test.

### 5.2 Standard Serviceability Test

The following procedure shows if the unit is serviceable and checks functions and facilities of the PACE1000.

#### Procedure



#### CAUTION

**Always release pressure before disconnecting pressure equipment from the outlet port.**

1. Connect the instrument (Ref: Installation, Section 2) Connect a UUT.
2. After power-up, select measure set-up.
  - a. Select the required units of pressure measurement from the measure set-up menu.
  - b. Apply a known pressure to one of the sensors. Make sure the instrument pressure reading is within tolerance, stated in the specification (Ref: SDS).
  - c. Carefully release the applied pressure to atmospheric pressure.
  - d. Make sure the instrument pressure reading shows atmospheric or ambient pressure.
  - e. Test complete.

After a successful serviceability test the instrument is ready for use.

### 5.3 Ethernet Testing

1. Connect PACE Ethernet port to a PC.
2. Check the PACE Ethernet LAN indication turns green after a few seconds.
3. Set the PACE Ethernet address to Auto IP.
4. Record the PACE auto IP address (The test screen below has auto IP address 3.115.21.237)
5. Open the PC command prompt screen.
6. Using the "ping" command, ping the PACE IP address (see screen capture below). The PACE will reply if operating correctly.

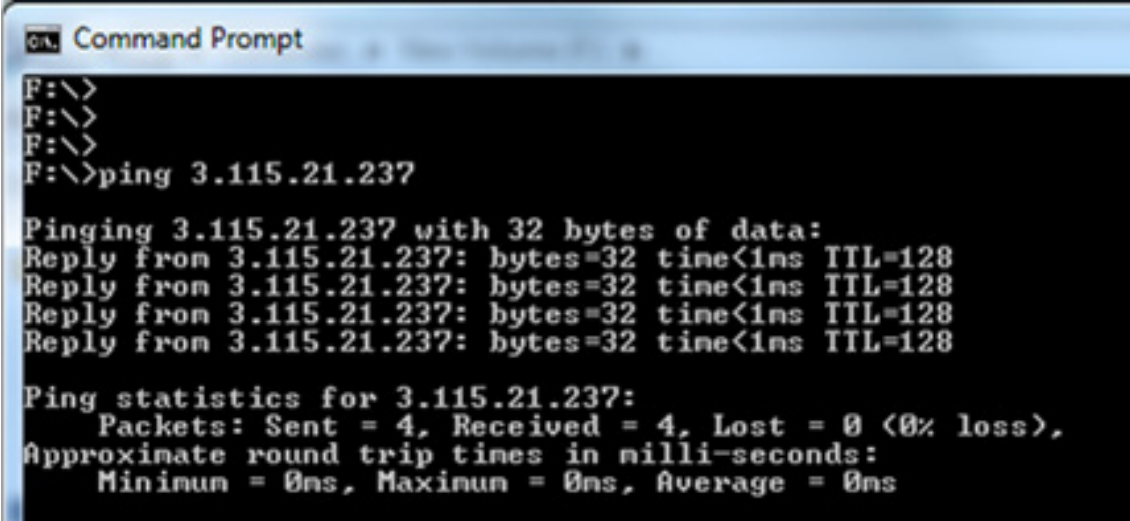

```
Command Prompt
F:\>
F:\>
F:\>
F:\>ping 3.115.21.237

Pinging 3.115.21.237 with 32 bytes of data:
Reply from 3.115.21.237: bytes=32 time<1ms TTL=128
Reply from 3.115.21.237: bytes=32 time<1ms TTL=128
Reply from 3.115.21.237: bytes=32 time<1ms TTL=128
Reply from 3.115.21.237: bytes=32 time<1ms TTL=128

Ping statistics for 3.115.21.237:
    Packets: Sent = 4, Received = 4, Lost = 0 (0% loss),
    Approximate round trip times in milli-seconds:
        Minimum = 0ms, Maximum = 0ms, Average = 0ms
```

Ethernet open ports and their usage:

80/tcp	PACE Web server (http)
111/tcp	ONC RPC port mapper
372/tcp	VXI-11 communication (Dynamically allocated)
443/tcp	Web server (https)
5025/tcp	PACE SCPI communication socket
111/udp	ONC RPC port mapper

## Ethernet testing using a web browser

Home

Lan Configuration

### Instrument Details

Druck-PACE1000	
Model	PACE1000
Manufacturer	Druck
SerialNumber	68795
Software Revision	01.06.06
Description	Druck, Pressure Indicator, PACE1000, 68795
HostName	pace68795
IPAddr	192.168.2.16
MacAddr	00-D0-1C-0B-1B-1A
TCP Address String	TCPIP::192.168.2.16::5025::SOCKET
VXI-11 Address String	TCPIP::192.168.2.16::inst0::INSTR

Identify Instrument:

## 5 Testing and Fault Finding

### Ethernet testing using NI

<http://www.ni.com/download/ni-daqmx-14.1/4953/en/>

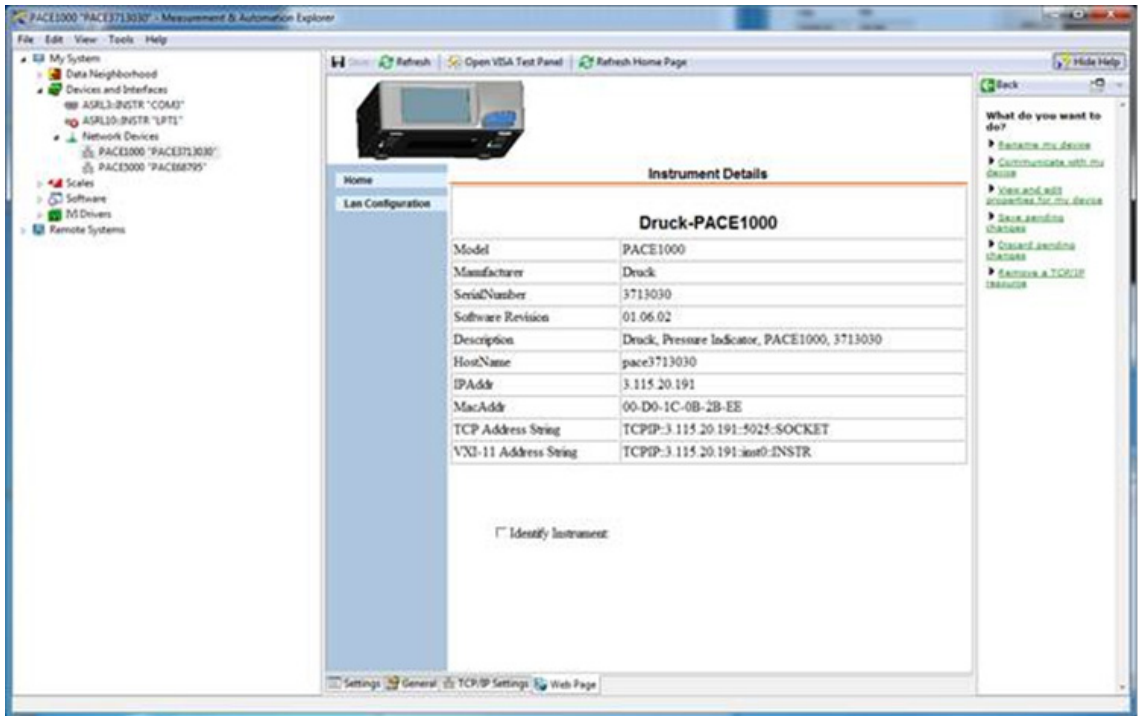

### 5.4 Fault Finding

Check the faults and responses (Ref: Table 5.1 Fault Diagnosis) before contacting [www.gemeasurement.com](http://www.gemeasurement.com) or a recommended Service Agent.

Fault	Response
Power supply connected, display not lit.	Check electrical power supply fuse or circuit breaker.
Display pressure reading in red	Over-range, carefully de-pressurize.
Instrument will not zero.	Vent system pressure. Check for blockage. Contact approved service agent for repair.

Table 5.1 - Fault Diagnosis

### 5.5 Approved Service Agents

For the list of service centres logon to [www.gemeasurement.com](http://www.gemeasurement.com)

## 6 Reference and Specification

### 6.1 Installation notes

The PACE1000 pressure indicator requires a set of connections with the exception of the reference connection, this provides a reference to atmosphere for gauge sensors and barometric sensors.

The gas density and type does not affect the accuracy of pressure measurement, assuming that the UUT is at the same level (height) as the indicator or gas head correction is accurately set.

Values of air density ( $\text{kg m}^{-3}$ ) for air of relative humidity 50% and containing 0.04% carbon dioxide by volume.

**Table 6-1 Air Density Values**

Air pressure (kPa)	Air temperature (°C)						
	14	16	18	20	22	24	26
87	1.052	1.045	1.037	1.029	1.021	1.014	1.006
88	1.064	1.057	1.049	1.041	1.033	1.025	1.018
89	1.077	1.069	1.061	1.053	1.045	1.037	1.029
90	1.089	1.081	1.073	1.065	1.057	1.049	1.041
91	1.101	1.093	1.085	1.077	1.069	1.061	1.053
92	1.113	1.105	1.097	1.089	1.080	1.072	1.064
93	1.125	1.117	1.109	1.100	1.092	1.084	1.076
94	1.137	1.129	1.121	1.112	1.104	1.096	1.088
95	1.149	1.141	1.133	1.124	1.116	1.108	1.099
96	1.162	1.153	1.145	1.136	1.128	1.119	1.111
97	1.174	1.165	1.156	1.148	1.139	1.131	1.123
98	1.186	1.177	1.168	1.160	1.151	1.143	1.134
99	1.198	1.189	1.180	1.172	1.163	1.154	1.146
100	1.210	1.201	1.192	1.184	1.175	1.166	1.158
101	1.222	1.213	1.204	1.196	1.187	1.178	1.169
102	1.234	1.225	1.216	1.207	1.199	1.190	1.181
103	1.247	1.237	1.228	1.219	1.210	1.201	1.193
104	1.259	1.249	1.240	1.231	1.222	1.213	1.204
105	1.271	1.261	1.252	1.243	1.234	1.225	1.216
106	1.283	1.274	1.264	1.255	1.246	1.237	1.228

**Note:** 100 kPa = 1 bar

## 6 Reference and Specification

---

### 6.2 Reference Port

The reference port provides the negative pressure to the gauge sensor and to the barometric reference (option). Gauge sensors use this port identified as "REF". For gauge sensors (without a barometric reference) small pressures can be applied (Ref: Specification, Section 6-7). All other pressure measurement requires the port to be opened to atmosphere. When in gauge mode, the instrument shows and controls the pressure difference between the reference port and the output port.

**Note:** *This is not a true differential operation as there is no true differential calibration of the sensor.*





































The transducer of the barometric reference option senses atmospheric pressure via the reference port, when enabled the port MUST be open to atmosphere. The reference connection should be actively used (differential connection option) for precision low pressure measurement. The instrument measures pressure relative to the pressure at the reference port.

An atmospheric pressure change causes the indicator to adjust the pressure and appears at the pressure output as apparent instability. To keep a stable controlled pressure, the reference port should be restricted. Using a reference port restrictor (snubber), short term ambient pressure variations can be prevented from affecting indicator performance. The indicator and UUT references should be connected together (using the optional differential connection kit) to provide a common reference to atmosphere.

# PACE Pressure Indicators User Manual

## 6.3 Icons

The following icons are used in the PACE series of instruments, not all icons are used in every PACE instrument.

























Display Icons in Set-up Menus					
Icon	Function	Icon	Function	Icon	Function
	Active		Aero set-up		Aeronautical
	Airspeed range		Alarm		Altitude range
	Area of use		Asterisk		Auto range
	Audio volume		Auto zero		Backlight
	Barometer		Basic		Burst pressure control mode
	Calibration		Calibration history		
	Change supervisor PIN		Communications		Contrast
	Control mode		Copy		Correction analogue output
	Correction SCM		Correction sensor		Correction source sensor
	Correction valve		Current set-up		Date & time
	Delete		Diagnostic analogue output		Diagnostic barometric option
			Diagnostic control sensor		Diagnostic controller
	Diagnostic general		Diagnostic RS232		Diagnostic source sensor





















## 6 Reference and Specification

Icon	Function	Icon	Function	Icon	Function
	Diagnostic vacuum sensor		Diagnostic volt-free		Diagnostics
	Display		Divider		Error
	Escape		Ethernet		Ethernet not connected
	Ethernet connected		Exclamation		Fault history
	Gas head pressure		Gauge mode		Global set-up
	Go-to-ground		Hardware build		Home
	Idle time-out		IEEE488		Information
	In limits		Instrument		Instrument accuracy
	Instrument alias name		Language		Leak test
	Lock		Lock tasks		Logic output
	Max-min		Max peak		Min peak
	Nudge		Passive mode		Percentage
	PIN		Power-up		Preset
	Pressure		Pressure filter		Process

# PACE Pressure Indicators User Manual

Icon	Function	Icon	Function	Icon	Function
	Protective vent		Question		Range
	Recall user set-up		Reset use log		Resolution
	Re-try		Roughing		RS232
	Restore to as shipped settings		Restore settings 2		Run
	Save as shipped		Save recall user set-up settings		Save user set-up
	Screen mode		Screen saver		SCM filter
	SCM zero		Select range		Set-point disable/enable
	Set-point limits		Set-point higher limit		Set-point lower limit
	Set date		Set serial number		Set time
	Set-up zero		Slew rate linear		Slew rate max rate
	Software build		Software upgrade history		Software upgrade
	Status		Status area		Step (single)
	Stop		Supervisor set-up		Switch test
	Tare		Support		Task

## 6 Reference and Specification

Icon	Function	Icon	Function	Icon	Function
	Test program		Test program copy		Test program delete
	Timing		Time out		Timed zero
	Units		User defined units		Use log
	Use log history		Vent		Vent time out
	Vent Yes/No		Vent set-up		Warning
	Zero analogue output		Zero history		Zero

### 6.4 Measure Set-up

#### **Pressure zero**

During use, the instrument pressure sensor can show small zero shifts caused by time and temperature changes. Regular “zeroing” increases measuring precision.

#### **Process**

Selects display processing features that change the reading, as follows:

**%:** Pressure can be displayed reading as a percentage of full-scale or as a percentage of a specified span.

**Filter:** The displayed reading can be filtered by a custom low pass filter or the filter can be disabled (**default disabled**). The indicator works at a speed independent of the filter time constant.

**Tare:** A specific tare value can be selected or the current displayed pressure reading can be “captured” as the tare value. The display shows the selected tare value in the pressure window.

**Peak:** Maximum, minimum and average display of pressure readings.

#### **Task**

Selecting Task enables a set of pre-determined functions and software enabled optional functions.

## **Units**

Select the new units from the list of pressure measurement units. Special units can also be defined (Ref: Global set-up, Section 6.6, supervisor set-up).

## **Global set-up**

Ref: Global set-up, Section 6.6.

## **Set-up zero**

Zero from top level screen (main range only).

If other ranges are fitted these can be zeroed by selecting the displayed reading.

## **Barometric Reference Option**

The barometric reference option measures the barometric pressure at the reference port. Depending on the sensors fitted, it also permits the indicator to operate in either pseudo-gauge or pseudo-absolute mode by the addition of barometric pressure.

## **6.5 Status**

The display shows the following:

### a. Instrument status

- Model
- Serial number
- MAC address sensor(s)
- Range
- Last calibration date\*

### b. Software build - read only data.

### c. Hardware build - read only data.

### d. History - read only data

- Calibration
- Zero
- Software
- Hardware
- Message
- Ethernet connection

### e. Communications, IEEE 488 and RS232 are fitted as standard. Additional communication types are options - USB and Ethernet.

### f. Current set-up - read only data.

### g. Support

- List contact information for support and advice.

## 6 Reference and Specification

---

### 6.6 Global set-up

#### Supervisor set-up

PIN protected menu (Ref: Supervisor set-up, Section 6.7).

#### Calibration

PIN protected menu (Ref: Calibration set-up, Section 6.8).

#### Save/recall user set-up

Save user set-up.

Recall user set-up.

#### Display

- a. Resolution
- b. Backlight
- c. Audio volume
- d. Status area
- e. Display Mode
  - Reading (default)
  - Graph

*\* The instrument date and time must have been set correctly.*

## 6.7 Supervisor Set-up

The Supervisor menu provides facilities for programming settings. These are usually made during installation as follows:

**Important Note:** *A PIN protects the Supervisor menu against unauthorised use. Each instrument on delivery contains the factory set PIN (0268). To continue protecting the supervisor set-up menu the PIN should be changed as soon as possible.*

### Alarms

An alarm can be set to trigger when the pressure exceeds the high alarm or falls below the low alarm. A buzzer sounds when the alarm triggers and the alarm symbol (bell) appears on the display.

### Comms

Selects the communication port parameters and simultaneous operation of the RS232, IEEE 488 interface and Ethernet.

**Note:** *PACE1000 Lab view drivers are available for download from:*

[http://sine.ni.com/apps/utf8/niid\\_web\\_display.download\\_page?p\\_id\\_guid=B6F9A6B06AEA01F1E0440021287E65E6](http://sine.ni.com/apps/utf8/niid_web_display.download_page?p_id_guid=B6F9A6B06AEA01F1E0440021287E65E6)

The user can select appropriate settings for communicating with the control computer (PC) and the required command protocol.

Referring to the PACE SCPI communications user manual there are three commands that can be used to retrieve pressure readings from the PACE100X:

<b>:INST:SENS[x]:READ?</b>	Where x = 1 to 8 set in the comms range menu
<b>:SENS:PRES?</b>	Returns the reading top main display window with display filtering (2Hz update rate) applied
<b>:DISP[x]:WIND?</b>	Where [x] = display (1=top main, 2=middle status area & 3= bottom function area) window

To obtain fastest readings you must use the following SCPI command **:INST:SENS[x]:Read?**

This command returns two readings, a filtered reading and a raw reading (unfiltered reading) from internal sensors, thus giving the user a choice of which reading to use which is most suitable for their application.

e.g.

**TX> :Inst:Sens2:Read?**

**RX> :INST:SENS2:READ "993.539148733033 993.543837356372"**

**Note:** *Raw reading returned from IDOS sensors is "0" as a raw readings cannot be obtained from IDOS sensors.*

Data throughput. Baud rates slower than 115k2 baud will slow the new data update rate pro-rata. Even at a 115k2 baud rate the readings are slower than using IEEE. IDOS is a slower sensor than internal sensors.

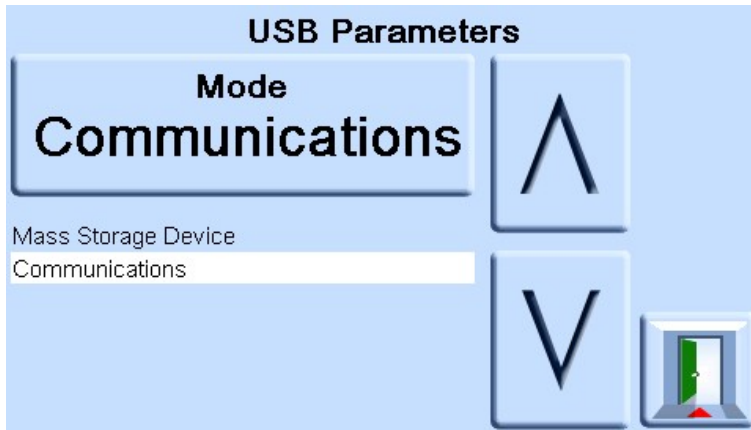

### RS232

Located on the rear panel an external RS232 connection requires the following:

Connector	9-way 'D' female wired as per Table 2-1
Communications	RS232 point-to-point only (daisy chain is not supported)
Baud Rate power-up default	9600, no parity & handshake = xon/xoff
Baud rates selectable **	2400, 4800, 9600, 19k2, 38k4, 57k6 & 115k2
Parity	None, Odd & Even
Flow control	None, Hardware & xon/xoff
Protocols	PACE SCPI
Heritage emulation	DPI 142/150, DPI 141
Terminator	CR or LF or CR/LF

\*\* *Selectable through the user interface.*

### RS232 Comms Range Setup

**Note:** The RS232 Comms Range values are set up by the user because of the hardware the user desires to operate with the PACE 1000 equipment. This procedure only allows supervisor to select these user pre-installed values. To initially define / change or delete the RS232 Comms Range values, refer to (Ref: K0472 PACE SCPI Remote Communications Manual).

1. On the main screen, touch any of the three horizontal touch areas on the screen.

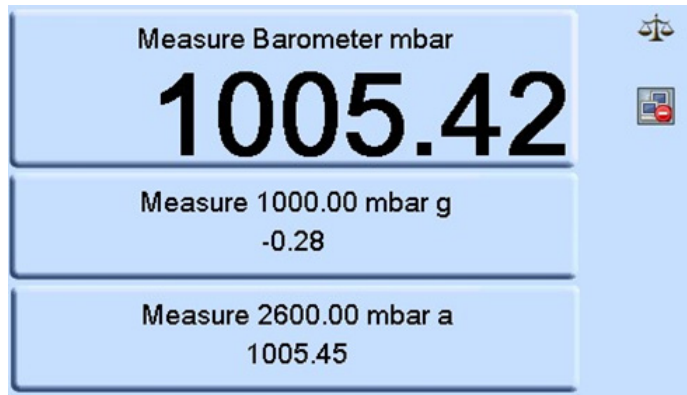

2. On the MEASURE SETUP screen, select GLOBAL SETUP.





## 6 Reference and Specification

---

3. Select SUPERVISOR SETUP.



4. Enter the Supervisor PIN and press the top touch area. Use the back arrow in the top right corner of the screen to delete any incorrect data entries.

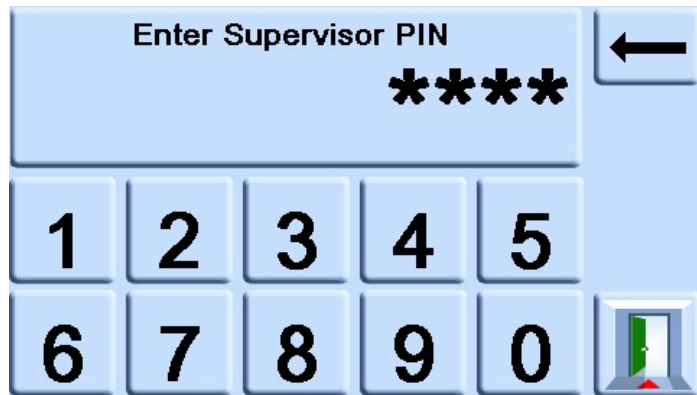

5. On the SUPERVISOR screen, select COMMS.

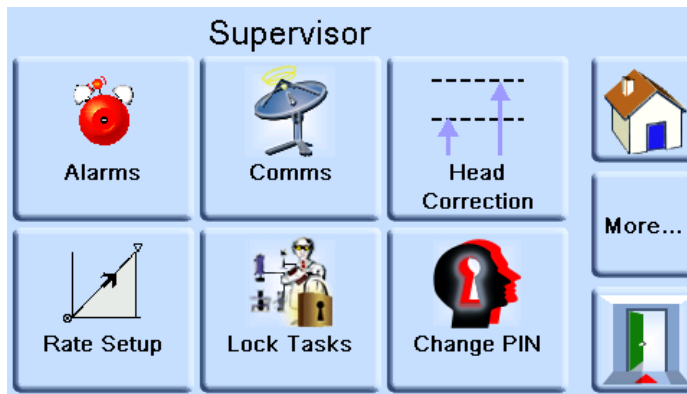

6. On the COMMUNICATIONS screen, select COMMS RANGE SETUP.



7. On the COMMS RANGE SETUP, Use the Up and Down arrows to highlight the desired Range (Ranges 1 to 10).

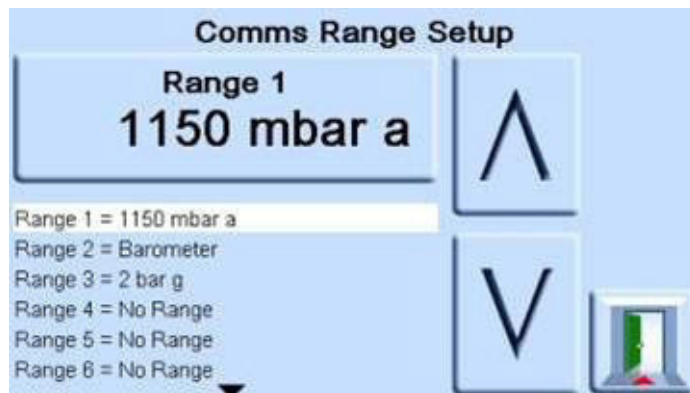

## 6 Reference and Specification

---

Comms range setup is used to re-align the SCPI index (x) to the correct pressure range. Where Range is index (1).....etc.

8. Press the top touch area on the screen to change the range value.
9. Use the Up and down arrow to highlight the new Range value.
10. Press the top Measure on the screen to change the range value. The new range value is set and the screen returns to the COMMS RANGE SETUP screen.
11. If necessary, repeat Steps 7 to 10 to set up other range values.
12. Press the Escape icon to go back to the COMMS RANGE SET UP screen.
13. When complete, press the Escape icon as necessary to return to the Measure screen.

### IEEE

Located on the rear panel an external IEEE 488 connection requires:

Connector	24-way 'D' female wired as IEEE 488 standard
Communications	IEEE488 GPIB
Default Address	16
Protocols	PACE SCPI
Heritage emulation	DPI 142/150, DPI 141

### Ethernet

Located on the rear panel an external Ethernet connection requires the following:

Connector	Ethernet RJ45
Protocol	SCPI
Terminator	CR/LF
Default Address	Auto IP (0.0.0.0)
Host name	PACExxxxxx ( <i>where xxxxxx = serial number</i> )
Web Password	0268
Access control	Open
Reset LAN Settings	Selected in Supervisor set-up menu

### Ethernet Firewall

A firewall protects the Ethernet connection. The firewall is always turned on. The following ports are unfiltered to allow remote communication and control.

<b>Port</b>	<b>Description</b>
80/tcp	http (Web server)
111/tcp	rpcbind (RPC for VXI)
111/udp	rpcbind (RPC for VXI)
443/tcp	https (Web server)

# PACE Pressure Indicators User Manual

---

5025/tcp	SCPI socket
*****/tcp	VXI-11 communication (dynamic port allocated)

## Ethernet Functionality

- PACE Ethernet supports both VXI-II and Sockets automatically.
- Socket port address 5025.
- Internet protocol IP4.

## Ethernet Parameters Range Setup

1. Touch any of the three horizontal Measure touch pads on the home screen to open the CONTROL SET UP screen.
2. On the MEASURE SETUP screen, select GLOBAL SETUP.



3. Select SUPERVISOR SET UP.



## 6 Reference and Specification

4. Enter the Supervisor PIN and press ENTER SUPERVISOR PIN. Use the back arrow in the top right corner of the screen to delete any incorrect data entries.

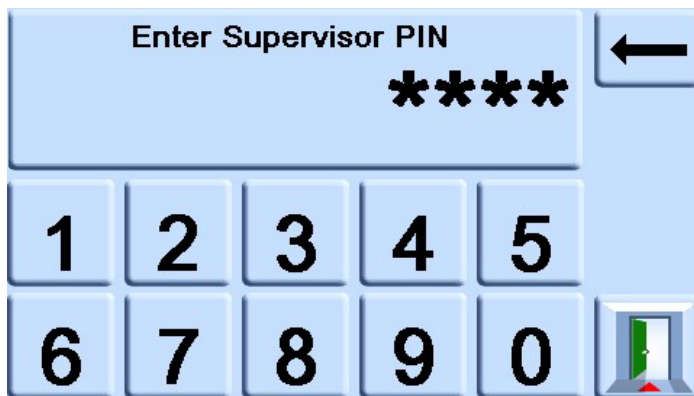

**Note:** The factory set Supervisor PIN is 0268. If the Supervisor PIN has been locally changed, make sure that the new PIN is kept in a safe place. If the new PIN is lost, it can only be reset at a GE Service Centre.

5. Press COMMUNICATIONS STATUS to open the COMMUNICATIONS STATUS screen.

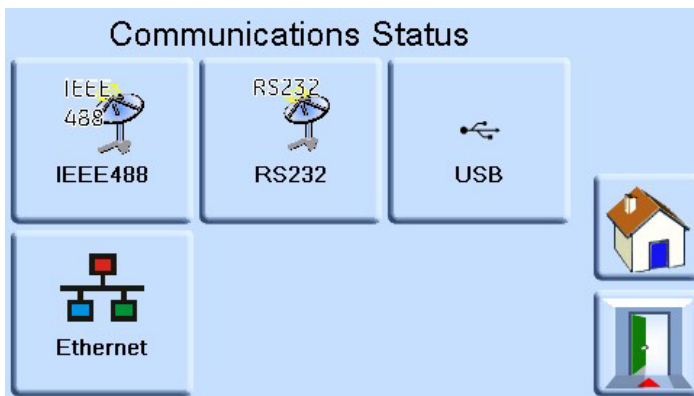

6. Select ETHERNET to open the ETHERNET PARAMETER screen.

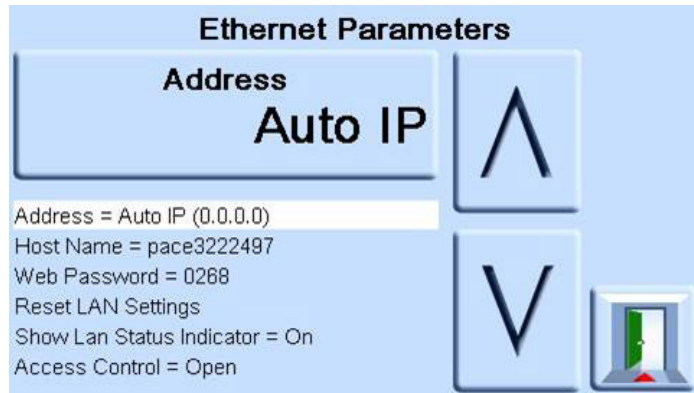

7. To change the ADDRESS parameter, complete the following:
  - a. On the ETHERNET PARAMETER screen, use the UP and DOWN arrows to highlight the ADDRESS field.
  - b. Press the top touch pad on the screen to enter the ADDRESS TYPE screen.

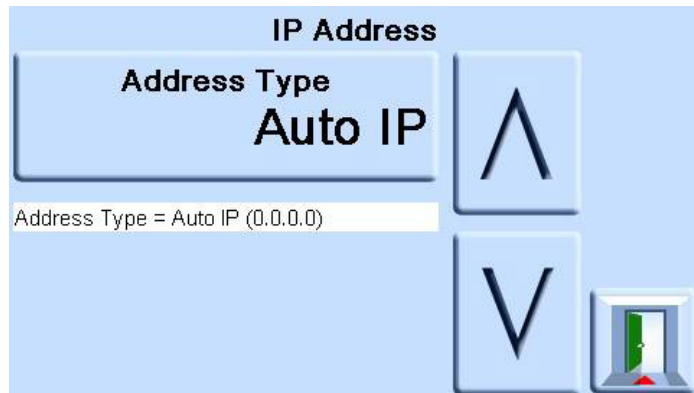

- c. Use the UP and Down arrows to highlight the desired address type (either AUTO IP or STATIC).

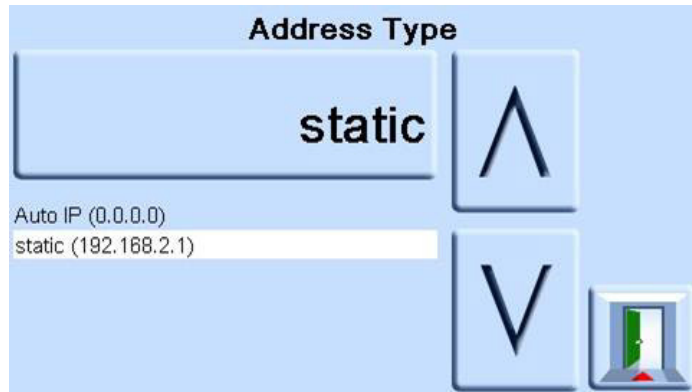

- d. Press the top touch pad on the screen to set the new address type. The screen automatically returns to the ETHERNET PARAMETERS screen.
8. To change the host name, complete the following:
- a. On the ETHERNET PARAMETER screen, use the UP and DOWN arrows on the right of the screen to highlight the HOST NAME field.

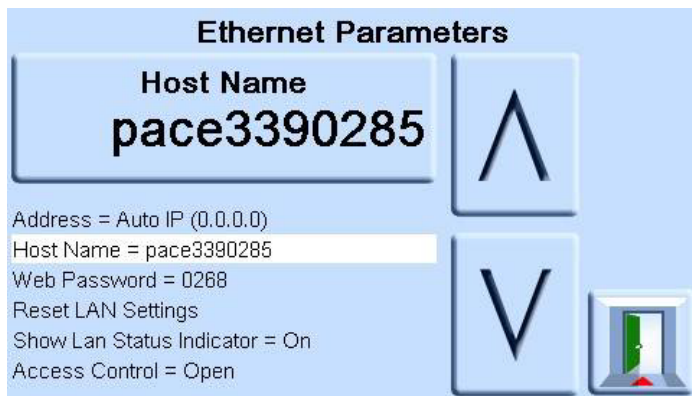

- b. Press the top touch pad on the screen to enter the HOST NAME screen.
- c. Use the keyboard to input the new host name and then press the top button on the screen to set the host name. The screen automatically returns to the ETHERNET PARAMETERS screen.



9. To change the web password, complete the following:
  - a. On the ETHERNET PARAMETER screen, use the UP and DOWN arrows on the right of the screen to highlight the WEB PASSWORD field.

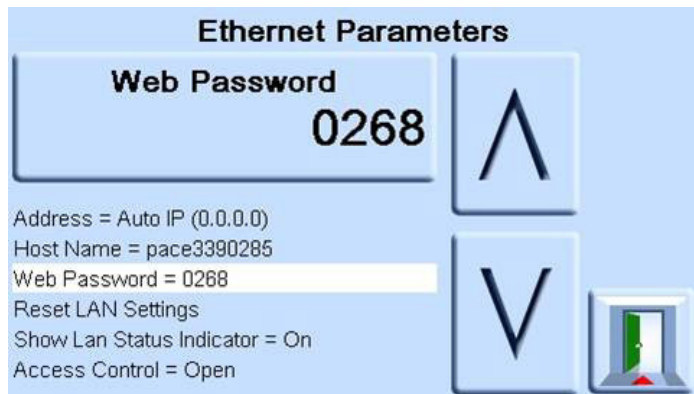

- b. Press the top touch pad on the screen to enter the WEB PASSWORD screen. The keyboard screen opens.





- c. Use the keyboard to input the new web password and then press the top touch area on the screen to set the new password. The screen automatically returns to the ETHERNET PARAMETERS screen.
10. To reset the LAN settings, complete the following:
  - a. On the ETHERNET PARAMETER screen, use the UP and DOWN arrows on the right of the screen to highlight the RESET LAN SETTINGS field.
  - b. Press the RESET THE LAN SETTINGS touch pad on the top touch pad of the screen.
  - c. The RESET LAN SETTINGS sub-screen asking for confirmation of the reset. Press YES to confirm reset of the LAN settings.

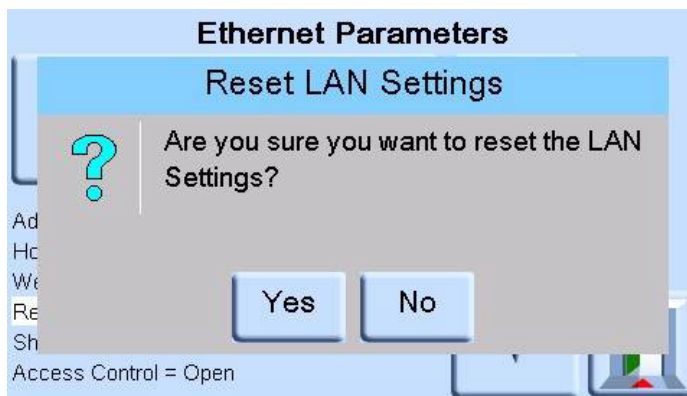

11. To turn the LAN status indicator on or off, complete the following:
    - a. On the ETHERNET PARAMETER screen, use the UP and DOWN arrows on the right of the screen to highlight the SHOW LAN STATUS field.

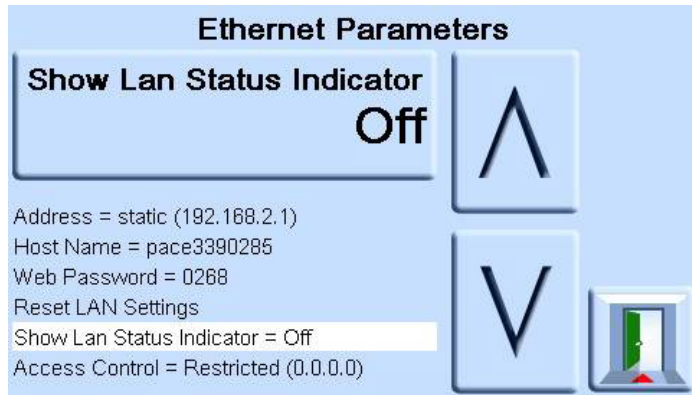

- b. Use the UP and DOWN arrows to highlight the desired setting. The setting is either ON or OFF.

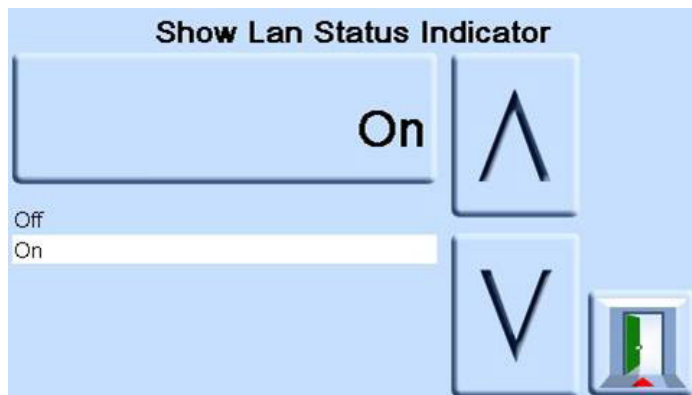

- c. Press the top touch pad on the screen to set the new setting.
12. To change ACCESS MODE, complete the following:
    - a. On the ETHERNET PARAMETER screen, use the UP and DOWN arrows on the right of the screen to highlight the ACCESS CONTROL field.

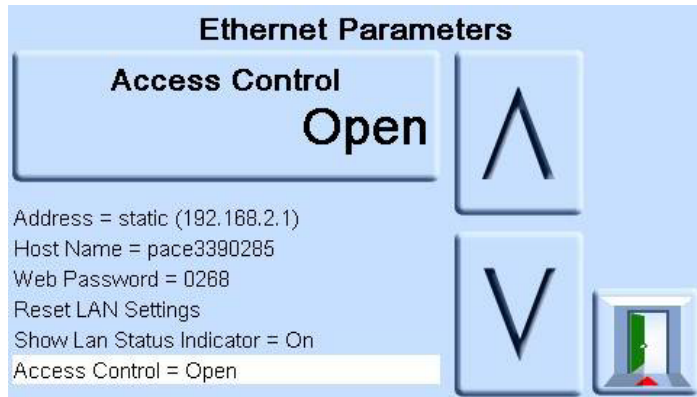

- b. Press the ACCESS CONTROL OPEN touch pad on the top of the screen to open the ACCESS MODE screen.



- c. Use the UP and DOWN arrows to highlight the required parameter. The choices are OPEN or RESTRICTED.

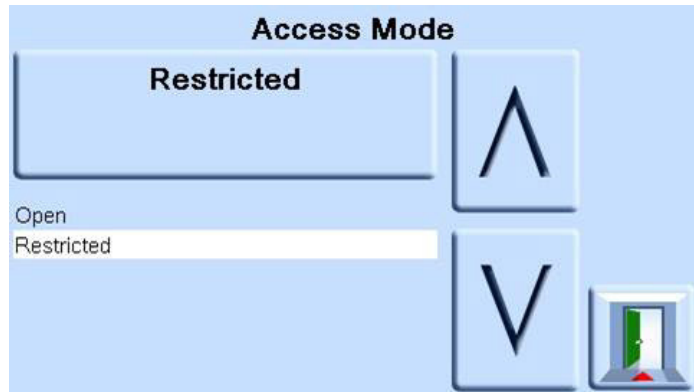

- d. Press the ACCESS MODE OPEN or ACCESS MODE RESTRICTED touch pad at the top of the screen to set the required access mode.

13. To change CONTROLLER IP ADDRESS complete the following:

- a. On the ETHERNET PARAMETER screen, use the UP and DOWN arrows on the right of the screen to highlight the ACCESS CONTROL field.

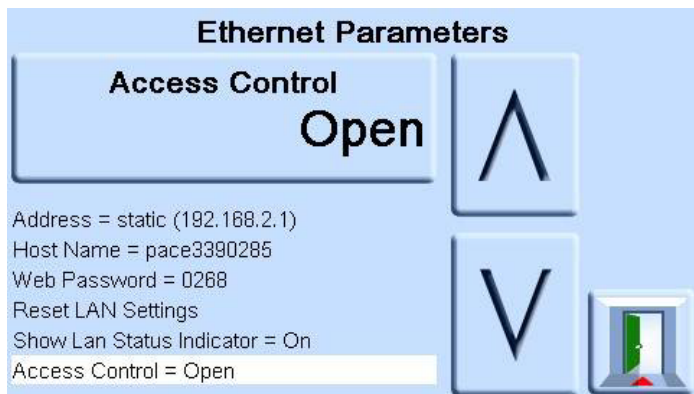

- b. Press the ACCESS CONTROL touch pad on the top of the screen.
- c. Use the UP and DOWN arrows to highlight the CONTROLLER IP ADDRESS field.



- d. Use the number touch pad at the bottom of the screen to input the new IP address and press the CONTROLLER IP ADDRESS touch pad at the top of the screen to set the new IP address.

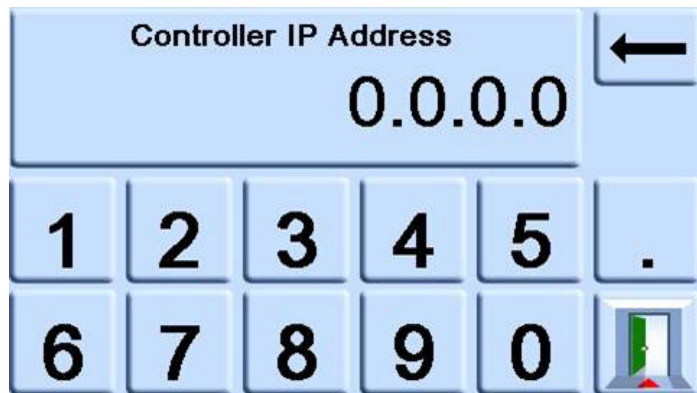

14. To view the recent IP addresses, complete the following:
  - a. On the ETHERNET PARAMETER screen, use the UP and DOWN arrows on the right of the screen to highlight the ACCESS CONTROL field.
  - b. Press the ACCESS CONTROL button on the top of the screen.
  - c. Use the UP and DOWN arrows to highlight the SELECT FROM RECENT field.

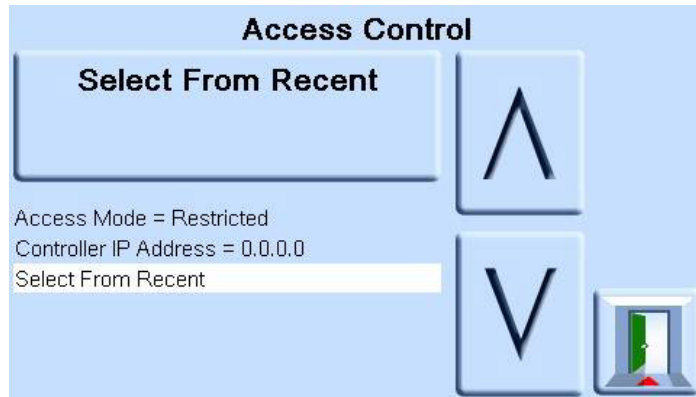

- d. Press the SELECT FROM RECENT button at the top of the screen to view the IP address history.

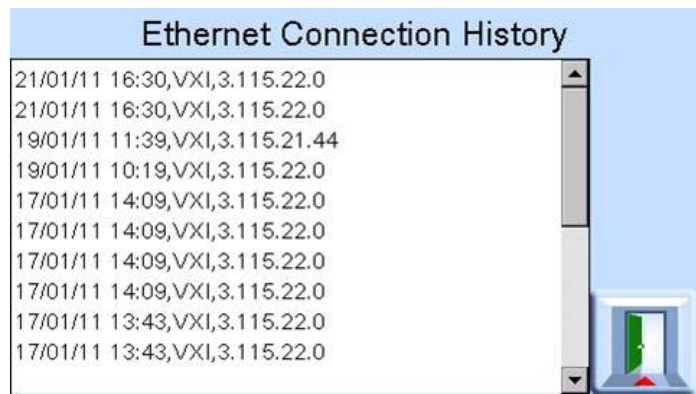

## ***Head Correction***

Corrects pressure reading for the height difference between instrument reference level and UUT. For accuracy, head correction must be enabled and the parameters set for each sensor:

- for UUT positioned higher than the reference level of the PACE1000 enter a positive height correction.
- for UUT positioned lower than the reference level of the PACE1000 enter a negative height correction.

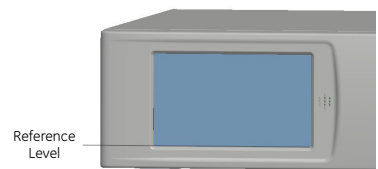

## 6 Reference and Specification

---

### **Lock Tasks**

#### Individual tasks:

Allows any combination of individual tasks to be disabled.

**Note:** *Restricts operation of the instrument to specific tasks or functions, recommended for production procedures.*

#### All:

Disables all tasks.

### **Change PIN**

Changes the Supervisor PIN: enter the existing PIN, then the new PIN and confirmation of the new PIN.

**Note:** *Confirmation of the new PIN permanently replaces the old PIN. Record this new PIN and keep in a safe place. If new PIN is lost it can only be reset by returning the instrument to a GE service centre.*

### **User defined units**

Permits the user to define a set of units. Following the on-screen prompts special units may be set by selecting a Pascal multiplier and assigning a five character name.

### **Instrument alias name**

Permits the user to define a 20 character alias name for the instrument. The instrument returns this name through the communications interfaces.

### **Language**

Operation in any of the languages refer to the SDS. *Further languages can be up-loaded.*

### **Restore as shipped settings**

Restores instrument settings to factory default.

**Note:** *Does not affect PIN settings.*

### 6.8 Calibration

The calibration menu provides facilities for programming settings for maintenance as follows:

**Note:** A PIN protects the Calibration menu against unauthorised use. Each instrument, on delivery, contains the factory set PIN (4321). To continue protecting the supervisor set-up menu, the PIN should be changed as soon as possible.

#### **sensor correction**

- Selects the range for a three-point calibration routine.

#### **screen calibration**

- Selects touch screen calibration routine.

#### **Time & Date**

- Sets instrument clock and date.

#### **Change PIN**

- Changes the Calibration PIN.
  - a. Enter the existing PIN
  - b. Enter the new PIN
  - c. Confirm the new PIN

**Note:** Confirmation of the new PIN permanently replaces the old PIN. Record this new PIN and keep in a safe place. If new PIN is lost it can only be reset by returning the instrument to a GE service centre. For more information regarding calibration, refer to PACE Calibration Manual K0450.

### 6.9 Specification

Refer to the PACE1000 data sheet for details.

**Note:** The data sheet is contained in the CD shipped with the product.



## 6 Reference and Specification

### 6.10 Options

#### Option enable process

To enable soft options on a PACE instrument, use the following:

1. Touch the top Measure area of the screen.
2. Select Global Setup.
3. Select Calibration.
4. Enter a Calibration PIN 1234.
5. Enter new option key xxxxxxxxxxxx (10 digits).
6. After entry of this key PACE confirms the options have been enabled.

**Note:** Hardware options automatically enable post installation

*Selects Analogue Output Range*

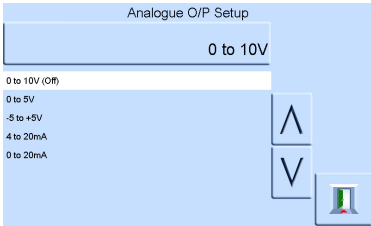

*On/Off*

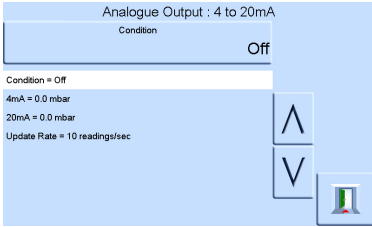

*Update rate of Analogue Output option from the control module.*

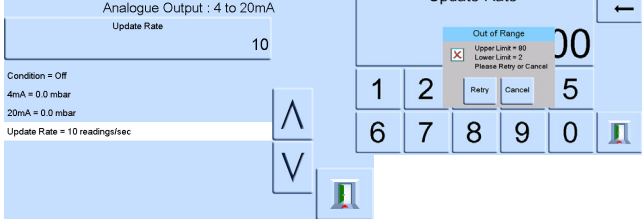

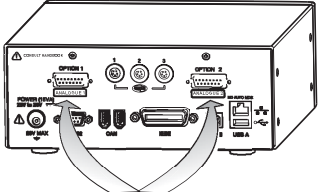

**analogue connections**

30V<sub>max</sub>

30V maximum with respect to chassis.  
Rated output = 24V

*To maintain PACE product safety, external circuits connected to the instrument must meet Safety Extra-Low Voltage (SELV) requirements.*

**15-way female D connector**

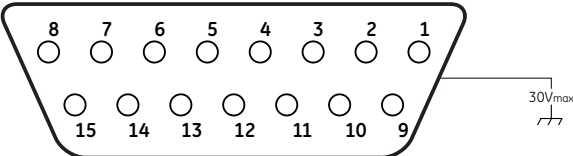

*Front view of Analogue Option PCB connector*

Analogue Output Bandwidth = 0.5 × Update Rate (Hz)

Pin number	Function	Pin number	Function
1	not used	9	not used
2	not used	10	0V return
3	not used	11	+24V DC OUT @ 100mA
4	not used	12	SW IN 1
5	not used	13	SW IN 2
6	not used	14	analogue +
7	not used	15	analogue -
8	not used		

## 6 Reference and Specification

### Volts-free Contact Option

The Volts-free Contact option provides a selectable relay contact toggle depending on conditions set in the PACE instrument.

Each selection has three Volts-free Contacts.

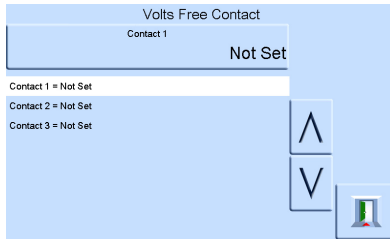

Selection of trigger conditions.

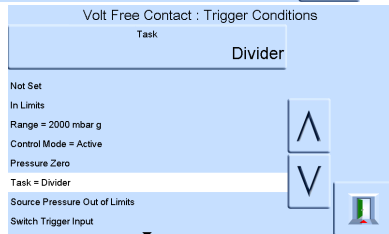

Selection of trigger conditions.

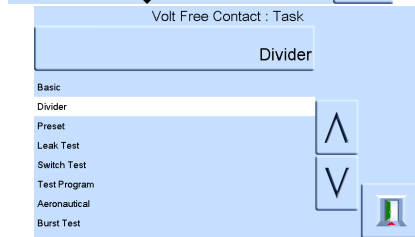

Relay contacts rated at 30 Vdc, 1 A resistive, 200 mA inductive.

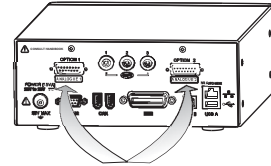

volts-free connections



30V maximum with respect to chassis.

Rated output = 24V

To maintain PACE product safety, external circuits connected to the instrument must meet Safety Extra-Low Voltage (SELV) requirements.

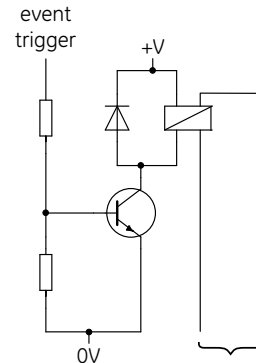

Typical Volts-free schematic

24 Vdc maximum  
30 Vdc wrt chassis  
1 A resistive maximum

Pin number	Function	Pin number	Function
1	Relay 1 normally CLOSED	9	Relay 3 common
2	Relay 1 normally OPEN	10	0V return
3	Relay 1 common	11	+24V DC OUT @ 100mA
4	Relay 2 normally CLOSED	12	SW IN 1
5	Relay 2 normally OPEN	13	SW IN 2
6	Relay 2 common	14	not used
7	Relay 3 normally CLOSED	15	not used
8	Relay 3 normally OPEN		

### 6.11 Installation and Ancillary Equipment Kit

Refer to the PACE1000 data sheet for details.

### 6.12 Return Goods/Material Procedure

If the unit requires calibration or is unserviceable return it to the nearest GE Service Centre listed at [www.gemeasurement.com](http://www.gemeasurement.com)

Contact the Service Department to obtain a Return Authorisation (Worldwide excluding USA).

In the USA obtain a Return Material Authorization [RMA].

Providing the following information on either a RGA or RMA:

- Product (i.e. PACE1000)
- Serial number
- Details of defect/work to be undertaken
- Calibration traceability requirements
- Operating conditions

#### Safety Precautions

You must inform GE if the product has been in contact with any hazardous or toxic substance.

The relevant COSHH or in the USA, MSDS, references and precautions to be taken when handling.

#### Important notice

Service or calibration by unauthorized sources will affect the warranty and may not guarantee further performance.

### 6.13 Packaging Procedure

1. The instrument should be at zero/ambient pressure.
2. Switch off and isolate the electrical power supply to the instrument.
3. Shut off the pneumatic pressure and vacuum supplies to the instrument.
4. Remove the instrument from the equipment rack to access the rear panel.
5. Disconnect the power supply cable and the pneumatic supply hose assemblies.
6. Stow the power supply cable in the packaging below.
7. Remove any pressure adaptors, diffusers and restrictors.

If available, use the original packing material. When using packing materials other than the original, do the following:

8. Fit protection to all the ports to prevent ingress of moisture and dirt.

**Note:** Use the original red plastic plugs or low tack masking tape.

9. Wrap unit in polyethylene sheeting.

## 6 Reference and Specification

---

10. Select a double-wall cardboard container.
  - Inside dimensions must be at least 15 cm (6") greater than the equipment
  - The carton must meet test strength requirements of  $\geq 125$  kg (275 lbs).
11. Protect all sides with shock-absorbing material to prevent equipment movement within the container.
12. Seal carton with approved sealing tape.
13. Mark carton "FRAGILE" on all sides, top, and bottom of shipping container.

### ***Environment***

The following conditions apply for both shipping and storage:

- Temperature range -20° to +70°C (-4° to +158°F)

