



User Manual

Temperature Calibrators – K0551

Series DryTC / LiquidTC



Please keep this operating manual for future reference.
If the device is resold, please provide the operating manual along with it.

Table of contents	page
0 About this operating manual	3
1 Description of the device	4
1.1 Intended use	5
1.2 Exclusion of liability	6
2 Safety Instructions.....	6
2.1 Safety instructions for the application of calibration liquids	8
3 Construction.....	9
3.1 Front of the controller	10
3.2 Data interface	11
3.3 Transmission protocol.....	11
4 Using Test Specimen Fixtures	12
4.1 Metal block calibrator	12
4.2 Infrared calibrator	12
4.3 Micro calibration bath	13
5 Commissioning	17
5.1 Start-up procedure	17
5.2 Switching on the calibrator / micro calibration bath	18
5.3 Reference and set temperature display	18
5.4 Stabilizing the reference temperature	18
6 Testing temperature sensors	19
7 Operating the Calibrator / Micro Calibration Bath	20
7.1 Calibrating (calibration mode).....	20
7.2 Setting a temporary set temperature (set point mode).....	21
7.3 Main menu	22
8 Cooling Down of the Metal Block / Liquid Bath.....	33
9 Cleaning and Maintenance.....	33
9.1 Maintenance	33
9.2 Cleaning.....	34
10 Problems	35
11 Warranty and Repairs	36
12 Recalibrating	36
13 Decommissioning and Disposal	36
14 Technical data	37
14.1 Shared characteristics	37
14.2 Characteristics DryTC series.....	38
14.3 Characteristics series LiquidTC	39

0 About this operating manual

The operating manual is aimed at specialists and semi-skilled personnel.

Before each step, read through the relevant advice carefully and keep to the specified order.

Thoroughly read and understand the information in the section "Safety instructions".

If you have any problems or questions, please contact your supplier or contact us directly at:



GE Measurement & Control Solutions
Fir Tree Lane, Groby Leicester
LE6 0FH
UK

Hazard signs and other symbols used:



CAUTION! Electric current!

This sign indicates dangers which could arise from handling of electric current.



WARNING! / CAUTION! Risk of injury!

This sign indicates dangers that cause personal injuries that can lead to health defects or cause considerable damage to property.



CAUTION! High temperature!

This sign indicates dangers resulting from high temperature that can lead to health defects or considerable damage to property.



CAUTION! Material damage!

This sign indicates actions which could lead to possible damage to material or environmental damage.



ADHERE TO OPERATING MANUAL!



NOTICE!

This symbol indicates important notices, tips or information.



NO DOMESTIC WASTE!

The device must not be disposed of together with domestic waste.



Pay attention to and comply with information that is marked with this symbol.



Follow the specified instructions and steps. Adhere to the given order.



Check the specified points or notices.



→ Reference to another section, document or source.



• Item.

Copyright notice:

The reproduction, distribution and utilization of this operating manual as well as the communication of its contents to others without express authorization is prohibited. Offenders will be held liable for the payment of damages. All rights reserved in the event of the grant of a patent, utility model or design.

1 Description of the device

The temperature calibrators in the DryTC / LiquidTC series are used for checking temperature sensors on site or in the lab.

The calibrator / micro calibration bath is a portable unit for service, industry and laboratory tasks. The GE temperature calibrators / micro calibration baths are intended to calibrate thermometers, temperature switches/thermostats, resistance thermometers and thermal elements.

Versions:

The series DryTC / LiquidTC include the following calibrator/micro calibration bath types:

Metal block calibrators	Micro calibration bath
DryTC 165 (c+h)	LiquidTC 165 (c+h)
DryTC 650 (h)	LiquidTC 255 (h)
c+h: cooling and heating h: heating	

Metal block calibrator

Micro calibration baths



DryTC 165



DryTC 650



LiquidTC 165















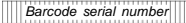



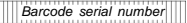

LiquidTC 255

Type plate:

You find the type plate on the rear of the device.

It includes the type designation, the serial number and the key electric specifications

(□ example).

 Dry TC 165 TEMPERATURE CALIBRATOR RANGE: -35 TO 165°C GE DRUCK, LE6 0FH, UK 110/230VAC 50/60Hz 400VA  T6.3AH 250V DATE OF MANUFACTURE: 0813 SERIAL NUMBER: 1308123  Barcode serial number  	 Dry TC 650 TEMPERATURE CALIBRATOR RANGE: TO 650°C GE DRUCK, LE6 0FH, UK 110/230VAC 50/60Hz 1000VA  T10AH 250V DATE OF MANUFACTURE: 0813 SERIAL NUMBER: 1308123  Barcode serial number  	 Liquid TC 165 TEMPERATURE CALIBRATOR RANGE: -35 TO 165°C GE DRUCK, LE6 0FH, UK 110/230VAC 50/60Hz 400VA  T6.3AH 250V DATE OF MANUFACTURE: 0813 SERIAL NUMBER: 1308123  Barcode serial number  	 Liquid TC 255 TEMPERATURE CALIBRATOR RANGE: TO 255°C GE DRUCK, LE6 0FH, UK 110/230VAC 50/60Hz 1000VA  T10AH 250V DATE OF MANUFACTURE: 0813 SERIAL NUMBER: 1308123  Barcode serial number  
--	--	---	---

Scope of delivery and accessories:

Before installing the device, check the delivered items and ordered accessories:

Temperature calibrator and accessories (included items):

<p>Metal block calibrator:</p> <ul style="list-style-type: none"> <input type="checkbox"/> Metal block calibrator as ordered <input type="checkbox"/> Mains connection cable <input type="checkbox"/> Adapter sleeve <input type="checkbox"/> Sleeve remover / Changing tool <input type="checkbox"/> Test certificate <input type="checkbox"/> Operating manual <input type="checkbox"/> Protective packaging and transport protection 	<p>Micro calibration bath:</p> <ul style="list-style-type: none"> <input type="checkbox"/> Calibration bath as ordered <input type="checkbox"/> Mains connection cable <input type="checkbox"/> Seal cover <input type="checkbox"/> Work cover with five silicone stoppers <input type="checkbox"/> Sensor cage <input type="checkbox"/> Magnetic stirrer <input type="checkbox"/> Magnetic lifter <input type="checkbox"/> Bilge pump <input type="checkbox"/> Bottle with silicone oil <input type="checkbox"/> Test certificate <input type="checkbox"/> Operating manual <input type="checkbox"/> Protective packaging and transport protection
--	---



Save the packaging

Temperature calibrators are delivered in special protective packaging.

↳ Save the packaging for returning the instrument safely to the manufacturer for recalibration or repair.

1.1 Intended use

The calibrators of the series DryTC / LiquidTC are only allowed to use for the test and calibration of temperature sensors.

The operational safety of the supplied instruments is only guaranteed if they are operated according to their intended use. Specified limit values (→ § 14 "Technical data") should never be exceeded.



CAUTION! Risk of severe burns!

Prior to transport or contact with the metal block / liquid bath ensure that it has cooled down sufficiently, otherwise there is a risk of severe burns caused by the metal block / liquid bath and the test specimen.



CAUTION! Material damage!

The opening in the metal block of the calibrator is only intended to be used with adapter sleeves or insert sleeves.

Using heat transfer media (oil, thermal paste or other media) can lead to incorrect measurements and damage to the calibrator.

↳ Never fill the calibrator opening with a heat transfer medium.

↳ Only micro calibration baths are suitable for use with heat transfer medium.

It is the users responsibility to select the instrument which is suitable for your specific application, to connect it correctly, to carry out tests and to maintain all the components

1.2 Exclusion of liability

We accept no liability for any damage or malfunctions resulting from incorrect installation, inappropriate use of the device or failure to follow the instructions in this operating manual.





2 Safety Instructions



Before you install the DryTC / LiquidTC, read through this operating manual carefully. If the instructions contained within it are not followed, in particular the safety guidelines, this could result in danger for people, the environment, and the device and the system it is connected to.

The temperature calibrator / micro calibration bath is a state-of-the-art device. This relates to the accuracy, functioning and the safe operation of the calibrator / micro calibration bath. However, professional and safety conscious conduct of the operator is required to ensure safe operation. GE provides support for the use of its products either personally or via relevant literature. The customer verifies that our product is fit for purpose based on our technical information. The customer performs customer- and application-specific tests to ensure that the product is suitable for the intended use. With this verification all hazards and risks are transferred to our customers; our warranty is not valid.

Environmental conditions:















-  The product is for indoor use only.
-  Operating altitude: Up to 2000 metres.
-  Mains supply: Transient overvoltages up to the levels of Overvoltage Category II.
-  Pollution degree: 2

Qualified personnel:

-  The personnel who are charged for the installation, operation and maintenance of the DryTC / LiquidTC must hold a relevant qualification. This can be based on training or relevant tuition. The personnel must be aware of this operating manual and have access to it at all times.

General safety instructions:

Always observe the following safety instructions in this operating manual.

-  In all work, the existing national regulations for accident prevention and safety in the workplace must be complied with. Any internal regulations of the operator must also be complied with, even if these are not mentioned in this manual.
-  Only use the DryTC / LiquidTC if it is in perfect condition. Damaged or faulty devices must be checked without delay and, if necessary, replaced.
-  Degree of protection according to EN 60529:
-  Ensure that the ambient conditions at the site of use does not exceed (comply with) the requirements for the stated protection rating (→ § 14 "Technical data").
-  Correct and safe operation of the calibrator / micro calibration bath demands correct transport, storage, installation and assembly, as well as proper use and careful operation and maintenance.
-  The calibrator / micro calibration bath should only be used for its intended purpose. Furthermore, hazardous media should not be used and all technical specifications have to be observed.
-  If faults cannot be cleared, immediately shut down the calibrator / micro calibration bath and ensure that it cannot be started up accidentally.
-  Prior to replacing the safety fuse, always de-energize the calibrator / micro calibration bath completely by disconnecting the mains cable from the mains outlet.
-  Ensure that the complete operating instructions are always available in excellent condition at the calibrator / micro calibration bath installation site.
-  Thermal fuse:
For protection purposes, the calibrator / micro calibration bath is equipped with an autonomous thermal fuse, which interrupts the power supply to the heater if the temperature exceeds a certain value inside the housing. Once the metal block / liquid bath has cooled down, the calibrator / micro calibration bath has to be returned to GE for inspection.
-  The calibrator / micro calibration bath has been designed as a measurement and control instrument. If the calibrator / micro calibration bath is used for purposes not expressly specified in these operating instructions, additional safety measures have to be taken.
-  The calibrator / micro calibration bath should NOT be used in explosive atmospheres without appropriate protection (flammable or explosive atmospheres).
-  If malfunctioning of the calibrator / micro calibration bath can result in personal injuries or damage to property, the system has to be protected with additional electromechanical protective equipment.
-  Do not remove or obliterate nameplates or other markings on the device, as otherwise the warranty is rendered null and void.

Ventilation ports:

-  Located both underneath and on top, should not be blocked or restricted.

Disconnecting device:

-  Do not position the equipment so that it is difficult to operate the disconnecting device.

Device protection:

- ⚠ If the equipment is used in a manner not specified by the manufacturer, the protection provided by the equipment may be impaired

Replacing detachable mains supply cords:

- ⚠ It is not allowed to replace detachable mains supply cords by inadequately rated cords.

IEC mains connector:

- ⚠ The IEC mains connector of the power supply cord is to be treated as the disconnect device, as the front panel switch is not rated as a disconnect device.

Special safety instructions:

(Further) Warnings that are specifically relevant to individual operating procedures or activities can be found at the beginning of the relevant sections of this operating manual.

2.1 Safety instructions for the application of calibration liquids

Calibration liquid water:

- ⚠ Only use distilled water, otherwise excessive limescale and soiling will build up in the calibrator tank.

Calibration liquid silicone oil:

- ⚠ Only use distilled water, otherwise excessive limescale and soiling will build up in the calibrator tank.
- ⚠ Always read the safety data sheet supplied with the silicone oil before using it.
- ⚠ Always ensure adequate ventilation when working with silicone oil, since hazardous substances can be released.
- ⚠ Prevent silicone oil from coming into contact with your eyes.
- ⚠ Since silicone oil is hygroscopic, always use the transport cover to close the calibration bath after use.

IMPORTANT NOTICE!

The transport cover is equipped with a safety valve, which is activated once the pressure reaches approx. 2.5 bar. This can result in hot steam being released.



- 🔧 Always unscrew the transport cover before putting the micro calibration bath into service, in order to avoid excessive pressure.
- 🔧 Wait until the micro calibration bath has cooled down before screwing on the transport cover.

3 Construction

The calibrator / micro calibration bath consists of a robust, black and red steel housing with an integrated carrying handle.

Components:

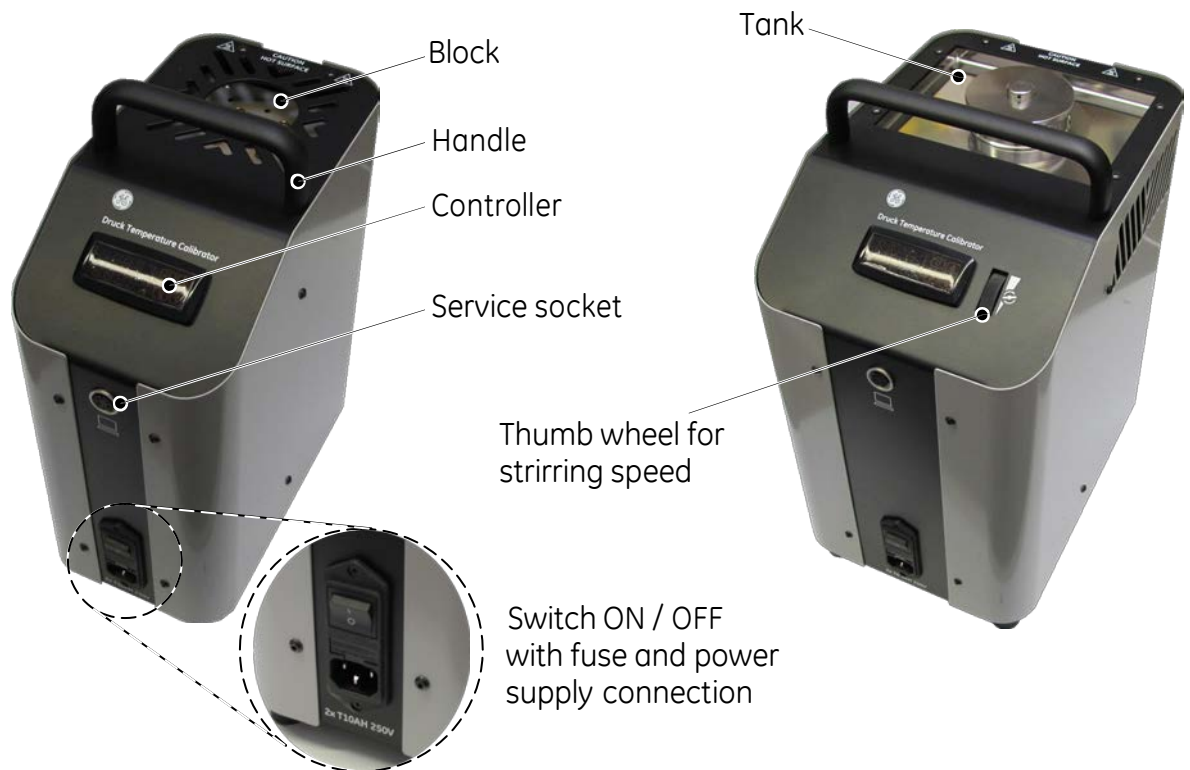

The rear part of the housing contains a metal block/liquid bath with a hole, accessible from the top, for the test specimen fixture.

The heating or cooling elements and the temperature sensor for determining the reference temperature are integrated in the metal block / liquid bath.

The metal block / liquid bath is heat insulated.

The front part of the housing contains the complete electronic unit for controlling the reference temperature.

Solid state relays (SSR) are used to control the heating and cooling elements.

A controller with a two-line, four-digit 7-segment LED display for the reference and target temperatures is located on the front panel.

The reference temperature can be set precisely with 0.1 °C (32.18 °F) resolution using the P and ▲ or ▼ buttons.

The micro calibration bath also has a thumb wheel for controlling the stirring speed.

A power supply switch is located on the front of the housing. This is also where the IEC plug with fuse for the mains supply can be found.

The 5-pole socket is provided for service purposes and is used as a data interface to the PC.

3.1 Front of the controller

Overview and function of the control elements of the controller:



1 - Upper display (red)

- Displays the current reference temperature.
- Displays the individual modes, menu items and parameters.

2 - Lower display (green)

- Displays the set temperature.
- Displays certain parameters in the individual modes and menu items.

3 - LED SET

- When flashing, it signals access to the individual menu items and parameters.

4 - P key

- Accessing the default set temperature.
- Accessing menu items and parameters.
- Confirming inputs.

5 - ▼ key

- Reducing the setting values.
- Selecting individual menu items.
- Returning to the previous menu level.

6 - ▲ key

- Increasing the setting values.
- Selecting individual menu items.
- Returning to the previous menu level.

7 - U key

Retrieving the saved set temperatures (only for the S version).

8 - LED OUT 1

Signals the status of the output for the temperature control:

- If the LED OUT 1 lights up, the calibrator / micro calibration bath is heating.
- If the LED OUT 1 does not light up, the calibrator / micro calibration bath is not heating.

9a - LED OUT 2

a) Heating instrument

Signals the status of the output for the fan control:

- If the LED OUT 2 lights up, the fan is running at high speed.
- If the LED OUT 2 does not light up, the fan is running at low speed.

9b - LED OUT 2

b) Heating and cooling instrument

Signals the status of the output for the temperature control:

- If the LED OUT 1 lights up, the calibrator / micro calibration bath is cooling.
- If the LED OUT 1 does not light up, the calibrator / micro calibration bath is not cooling.

3.2 Data interface

The DryTC / LiquidTC series is equipped with a serial communication interface. It is possible to connect a PC via an optional USB converter via this interface.

The utilized software protocol is a MODBUS-RTU protocol, which is used in numerous market-available monitoring programs.

The 5-pole socket is provided for connection of USB converter.

The PC connection enables the programming of the calibrator's parameters.

The minimum requirements for operation with a USB converter are:

- IBM compatible PC,
- an installed Windows operating system 98SE, ME, 2000, XP, 7 or 8 (Home or Professional), a free USB port (USB 1.1 or USB 2.0).



PLEASE NOTE:

If you access the programming via the keypad while communication via a serial interface is running, the message "**buSy**" appears on the display.

3.3 Transmission protocol

Is supplied as an additional document on request.

4 Using Test Specimen Fixtures

The temperature calibrators in the DryTC / LiquidTC series can be used with various test device fixtures, depending on the model.

Configuration as a metal block calibrator, infrared calibrator or micro calibration bath is easily performed with minimal effort.

4.1 Metal block calibrator

Insertion sleeves with one or more boreholes are used for the calibration of straight temperature sensors.

In order to achieve the best possible accuracy, the utilization of exactly fitting sleeves is necessary.

The diameter of the test specimen has to be determined precisely. The bore in the sleeve results from the addition of +0.5 mm.

Before use:

- Using the sleeve changing tool, fit the appropriate insertion sleeve in the block of the calibrator.

After use:

- Remove the sleeves after use with the aid of the sleeve remover, and remember to clean the sleeve and the block. This prevents the sleeves becoming jammed in the heating block.



Sleeves and sleeve remover

4.2 Infrared calibrator

A special infrared insertion sleeve is used for contactless infrared thermometers to enable fast, easy calibration.

The hollow and specially constructed insertion sleeve is fitted with two additional boreholes - for precise monitoring of the temperature - in the rim (1 x 3.5 mm und 1 x 4.5 mm).

Before use:

- The insertion sleeve is inserted into the block with the aid of the sleeve remover.

After use:

- Remove the sleeves after use with the aid of the sleeve remover, and remember to clean the sleeve and the block. This prevents the sleeves becoming jammed in the heating block



Sleeve for Infrared

The special construction and surface condition of the sleeve is such that it reaches emissivity of 1 (black body). When using an infrared insertion sleeve, the measuring spot of the pyrometer to be calibrated may, under no circumstances, be larger than the diameter of the infrared sleeve.



FORMATION OF ICE AND DEW!

At temperatures $< 0\text{ }^{\circ}\text{C}$ ($32\text{ }^{\circ}\text{F}$) and higher humidity levels ice or condensation can form in the insert sleeve. This can result in the calibration of the infrared thermometer being distorted.

The forming of ice or condensation can be significantly reduced by covering the measuring opening of the insert sleeve.

- ↪ Keep the measuring opening closed for as long as possible.
- ↪ Only open the measuring opening briefly for measuring.
- ↪ Existing ice or condensation can be removed by heating the insert sleeve

4.3 Micro calibration bath

ATTENTION! Safety valve!



The transport cover is equipped with a safety valve, which is activated once the pressure reaches approx. 2.5 bar. This can result in hot steam being released.



- ↪ Always unscrew the transport cover before putting the micro calibration bath into service, in order to avoid excessive pressure.

The micro calibration bath is used for calibrating sensors with special shapes or dimensions. Direct contact between the sensor and the calibration liquid ensures excellent heat transfer. The magnetic stirrer ensures a uniform temperature distribution in the calibration liquid.

The calibration liquid is poured directly into the tank or into a tub insert.

Tub insert:

We recommend using a tub insert if you:

- frequently change between dry block, infrared, surface and micro calibration bath configurations;
- frequently work with different calibration liquids.

Use the sleeve changing tool, fit the tub insert in the block.

Just like the tank, the tub insert can be closed with the associated cover. Both threaded covers are leakproof, so the calibration liquid can be left in the tank or the tub insert during transport.



4.3.1 Characteristics of the calibration liquids

Different calibration liquids supply varying calibration results due to their specific characteristics. Adjustment to the respective calibration liquid has to be carried out by the manufacturer.

In order to achieve the best possible accuracy of a micro calibration bath, it has to be filled with a suitable calibration liquid.

We recommend the following calibration liquids for the various temperature ranges:

Calibration liquid	Calibration Range		Flash Point
Distilled water	0 °C (32 °F)	95 °C (203 °F)	not any
XIAMETER® PMX-200 SILICONE FLUID 10 CS	-35 °C (-31°F)	155 °C (311°F)	165 °C (329 °F)
XIAMETER® PMX-200 SILICONE FLUID 50 CS	25 °C (77 °F)	270 °C (518 °F)	280 °C (536 °F)

When using water as the calibration liquid:

- ☞ Only use distilled water, otherwise excessive limescale and soiling will build up in the calibrator tank.

When using silicone oil as the calibration liquid:

- ☞ Only use the silicone oil recommended in these operating instructions.
- ☞ Always read the safety data sheet supplied with the silicone oil before using it.
- ☞ Always ensure adequate ventilation when working with silicone oil, since hazardous substances can be released.
- ☞ Prevent silicone oil from coming into contact with your eyes.
- ☞ Since silicone oil is hygroscopic, always use the transport cover to close the calibration bath after use. After periods without use heat the liquid well progressively in small steps to allow safe water boil-off.

IMPORTANT NOTICE!

 Only use clean calibration liquid. Checking temperature sensors and other temperature detection means can lead to a contamination of the calibration liquid. This contamination can lead to smeary gel effect on the bottom of the tank due to the rotation of the magnetic stirrers.

- ☞ Clean the tank.
- ☞ Clean before calibration of the sensors.
- ☞ Exchange the worn magnet stirrer.
- ☞ Exchange dirty, smeary calibration fluid.

4.3.2 Information on filling amounts

CAUTION! Risk of incorrect measurement or material damage.

Do not exceed the maximum fill level during operation.



Above the maximum fill level the heat dissipation is too great, preventing compliance with the specified tolerances.

Overflow of the calibration liquid causes contamination and can damage the calibrator.

☞ Ensure that the maximum fill level is not exceeded during operation.

The fill level in the tank or tub insert rises as a result of:

Thermal expansion

Calibration liquids expand to varying degrees as a result of heating. The increase in fill level depends on the calibration liquid that is used and the reference temperature setting.

Displacement by sensors

The volume displaced by the sensors being calibrated must be taken into account in the filling amount.

Rise due to stirring

The rotation of the magnetic stirrer forms a whirlpool in the liquid. This raises the fill level at the wall.

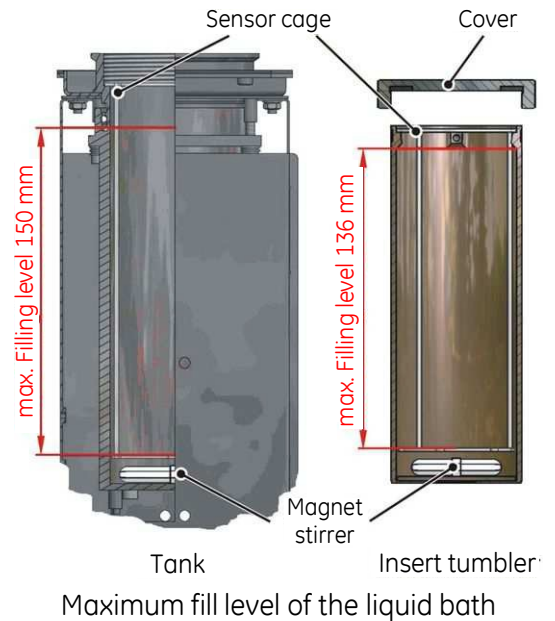

Tank:

The max. filling level in the tank is displayed by the upper edge of the aluminium lining.

The max. filling level is ~0,45 litres.

Tub insert:

The maximum fill level with the tub insert is below the fixture for the sleeve changing tool.

The maximum filling amount is approximately 0.32 litres.

4.3.3 Filling the micro calibration bath



Observe § 4.3.2 "Information on filling amounts"!

↳ When filling, leave enough room for thermal expansion, displacement by sensors and level rise due to stirring.

- ↳ Remove the transport cover.
- ↳ Place the magnet stirrer in the tank.
- ↳ Place the sensor cage inside.
It protects the magnetic stirrer. It also prevents blocking and ensures proper stirring



Tank

- ↳ Using the sleeve changing tool, fit the tub insert in the block or tank (only if a tub insert is used).
- ↳ Insert the test specimen into the sensor cage; in this way the volume of the sensor to be inspected will be taken into account.
- ↳ Pour the calibration liquid into the tank or tub insert.
Leave enough space for additional rise in the fill level.



Tub insert *1

WORK COVER!

For calibration use the included work cover.

It ensures stable positioning of the test specimens in the calibration bath. Evaporation of the calibration liquid is minimised by the work cover and the silicone stoppers.



- ↳ Screw the work cover onto the tank and insert the sensors through the work cover into the tank.



*1 Some steps are unnecessary if the tub insert is already filled.

4.3.4 Operating the magnetic stirrer

The best possible homogeneity is achieved by stirring the calibration liquid with the magnetic stirrer.

- ↪ Set the stirring speed to the respective max. speed. Turn the thumb wheel (Fig. 11) upwards to increase and downwards to decrease the stirring speed.



Liquid bath



Front of the controller with stirring speed wheel



Wearing part!

The magnetic stirrer is a wearing part.

- ↪ Replace worn-out magnetic stirrers.
- ↪ When using the multifunction calibrator remove the sensor cage after calibration. The calibration liquid should be removed after use with the aid of the special bilge pump. Clean the sensor cage and tank before putting any other insertion sleeves into the tank. This will prevent the sleeves becoming jammed in the tank.

5 Commissioning

Before switching on the calibrator or the first time, please follow the instructions in the following section.

Working surface:

The calibrator / micro calibration bath has to be placed in a vertical standing position for operation, this position guarantees optimum temperature distribution in the metal block / liquid bath.

5.1 Start-up procedure

If the calibrator is not used for a longer period, it is possible for moisture to enter the heating elements due to the material used (magnesium oxide).

After calibrator transport or storage in a damp environment, the heating elements have to be gently brought up to operating temperature. During the drying out procedure it has to be assumed that the calibrator has not yet achieved the required insulation voltage for protection class I.

The start-up set point is $T_{\text{start}}=120^{\circ}\text{C}$ (248 °F) for a stop period of $t_{\text{h}}=15$ min.

5.2 Switching on the calibrator / micro calibration bath

- ↪ Connect the supplied mains plug to a mains outlet.
- ↪ Actuate the mains switch.

The controller is initialized.

tEst appears on the upper display.

The version number, e.g. rL 2.2, appears on the lower display.

Initialization is completed after approx. 5 sec., the calibration mode is then automatically displayed.

The installed heating and cooling elements automatically adjust the metal block from the room temperature to the set temperature set at the controller.

5.3 Reference and set temperature display

Upper display (red):

The red, 4-digit, 7-segment display shows the current temperature of the metal block / liquid bath. When using the calibrator / micro-calibration bath with more than one function then the chosen function will be displayed in alternation.



Reference and set temperature display

Lower display (green):

The green, 4-digit, 7-segment display shows the current set temperature of the metal block / liquid bath.

Once the set temperature has been achieved, the radiated heat energy from the metal block / liquid bath is supplied by short firing pulses, thus ensuring that the temperature inside is kept constant.

5.4 Stabilizing the reference temperature

The switch on time of the heater is displayed by the red LED OUT 1 an.

During the heating up phase a constantly lit LED displays the supply of heat energy, a flashing LED indicates that the reference temperature has almost reached the set temperature and the heat energy is now being supplied at short intervals.

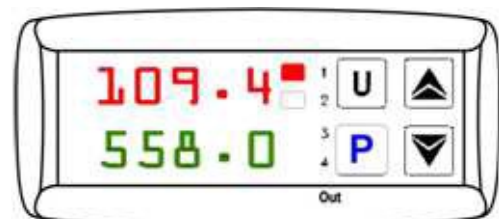

LED OUT 1 displays

In order to guarantee excellent temperature stability, the cycle time of the controller is set to low and the control output is addressed on a regular basis.

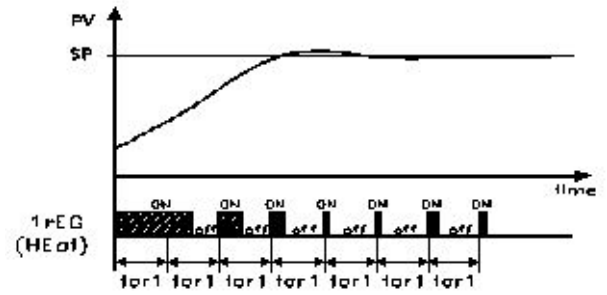

Control occurs via PID algorithm

6 Testing temperature sensors

A separate temperature measuring instrument connected to the test specimen is required to test the temperature sensors. By comparing the temperature displayed at the external measuring instrument with the reference temperature it is possible to assess the status of the test specimen. Remember that the test specimen requires a short period of time until it absorbs the temperature of the metal block or liquid bath.

The internal references are set to normal when operating the multifunction calibrator, the microbath, the dry block and the infrared function; the selector switch should be turned to int. Ref.



CAUTION! Incorrect results!

It is not possible to calibrate earthed thermal elements, because the heating block is earthed and any measurement would produce incorrect results.

7 Operating the Calibrator / Micro Calibration Bath

Three operating modes are available:

Calibration mode:

This is the normal operating mode in which the calibration of test specimens is carried out.

Set point mode:

The set temperatures can be entered in this mode.

Main menu:

All the settings can be carried out in this mode, e.g. presetting the set temperatures or setting the control parameters.

7.1 Calibrating (calibration mode)

The calibrator / micro calibration bath is automatically in calibration mode as soon as it has been switched on and after initialization.

The current reference temperature is displayed by the upper display.

The set temperature is displayed by the lower display.

The LED OUT 1 indicates the status of the output for the heater control:

If LED OUT 1 lights up, the temperature is being increased.

If LED OUT 1 does not light up, the heater is switched off.



Calibration mode HEATING displays

The LED OUT 2 indicates the status of the output for the fan / cooling control:

a) Heating instrument

The LED OUT 2 indicates the status of the output for the fan control:

If the LED OUT 2 lights up, the fan is running at high speed.

If the LED OUT 2 does not light up, the fan is running at low speed.

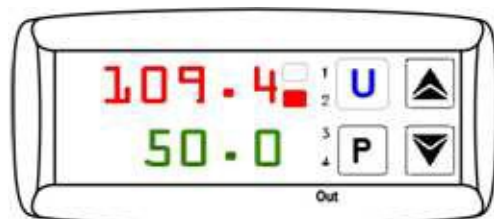

Calibration mode FAN or COOLING displays

b) Heating and cooling instrument

The LED OUT 2 indicates the status of the output for the cooling control:

If LED OUT 2 lights up, the temperature is being decreased.

If LED OUT 2 does not light up, cooling is switched off

There are two ways to set the set temperature: Either you set a temporary set temperature (□ § 7.2) or you save fixed set temperatures in the main menu (→ § 7.3).

7.2 Setting a temporary set temperature (set point mode)

In this operating mode it is possible to temporarily modify a saved set temperature.

- ↪ Press the P key shortly.
The currently active set point memory, e.g. SP 2 (set point 2), is displayed by the upper display.
The respective set temperature is displayed by the lower display.
- ↪ Press the ▲ key to increase the set temperature.
Press the ▼ key to decrease the set temperature.
- ↪ Press the P key again to confirm the new set point.

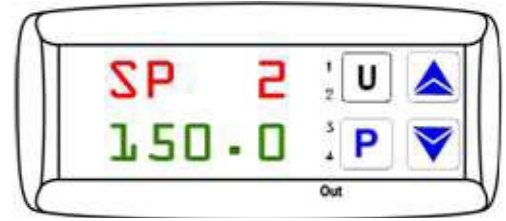

Temporary set temperature setting

NOTES:



Press the ▲ and ▼ key to raise and lower the value by 0.1 respectively. If the keys are held pressed for at least one second, the value increases or decreases quickly and after two seconds even more quickly; this means the desired value can be reached rapidly.

If no key is pressed in the set point mode for approx. 15 seconds, the device automatically returns to the calibration mode.

7.3 Main menu

All the settings can be carried out in this menu structure.

- ↳ Press the **P** key for approx. 5 seconds. The main menu opens.
- ↳ Use the **▲** and **▼** keys to select the desired main menu (see overview).
- ↳ Press the **P** key to confirm the selected menu item.

Main menu for calibrator or micro calibration bath

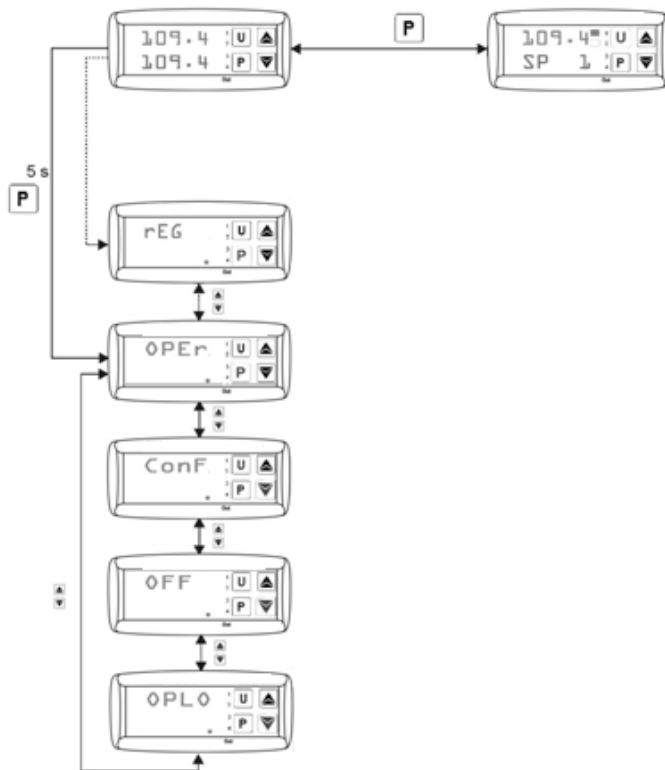

Main menu for simple temperature calibrator or micro calibration bath



NOTICE!

The S version provides certain additional functions, e.g. storage of four different set temperatures or setting of the control parameters.

Main menu for multifunction calibrator:

In order to operate the multifunction calibrator in the chosen function, the correct linearisation must be entered into the controller.

For this, four additional options are available in the main menu:

1. LI Micro-calibration bath function.
2. DB Dry block function.
3. Ir Infrared black body function.

In calibration mode, the upper display will then show the chosen linearisation (LI, DB, or IR) every 5 seconds in alternation with the actual temperature.

The internal references are set to normal when operating the micro-bath, the dry block and the infrared function.

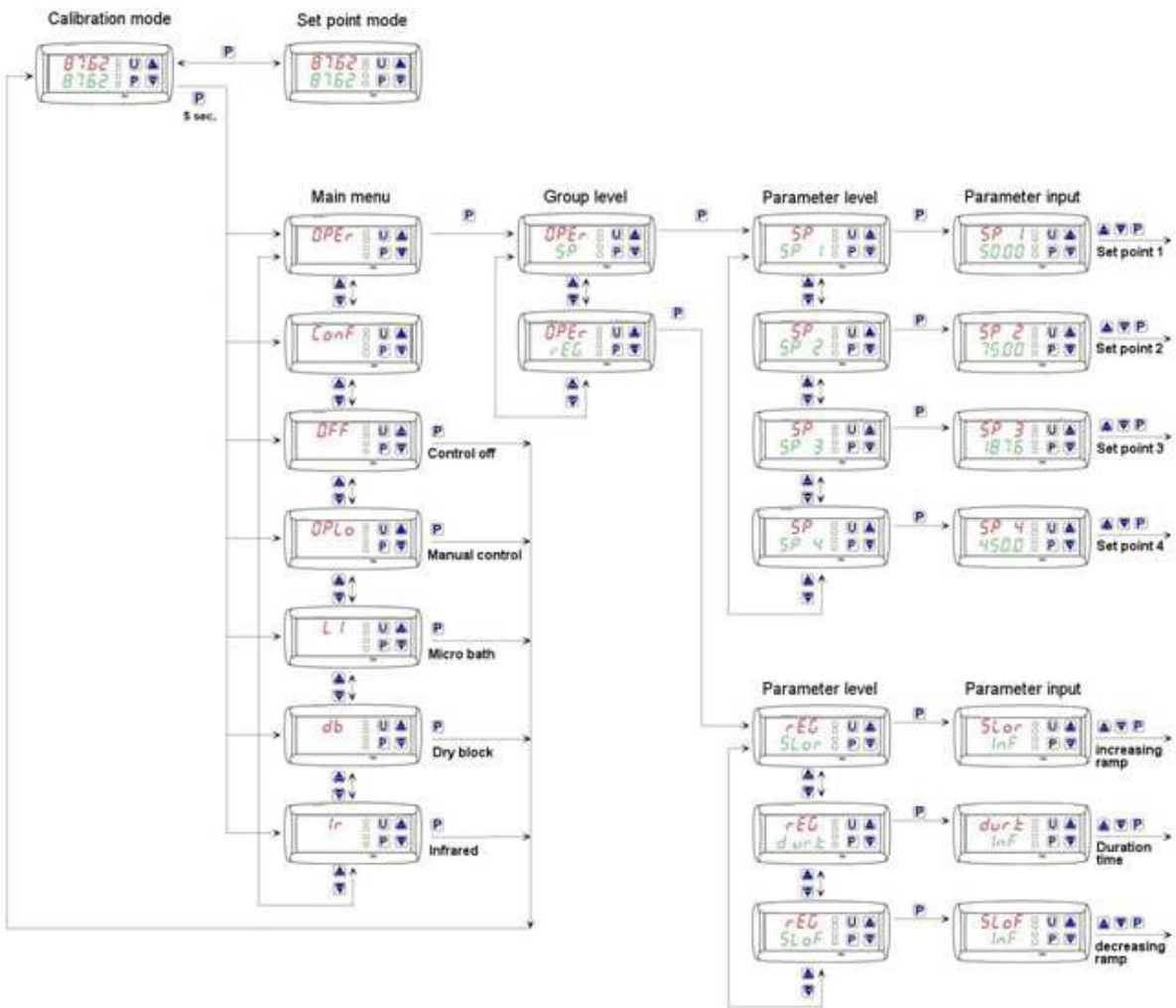

Menu structure S... versions

As displayed by the menu structure, it is possible to reach the group and parameter levels to carry out settings via OPER.



PLEASE OBSERVE:

Many of the described settings can only be carried out in the S version, but this is displayed in the chapter heading.

Returning to another level

If no key is pressed in the main menu at the group or parameter level for approx. 15 seconds, the device automatically returns to the previous level up to the calibration mode.

You can also return to a previous level by pressing and holding the ▲ or ▼ key.

7.3.1 Automatic control

For certain tasks it can be advantageous to switch off the control, e.g. to carry out settings at the calibrator / micro calibration bath.

Switching off automatic control:

- ☞ Press the **P** key when in calibration mode for approx 5 sec., the main menu opens.
The last selected function appears on the upper display.
LED SET flashes on the lower display.

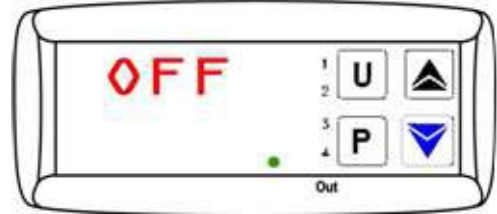

Menu control OFF

- ☞ Press the **▲** or **▼** key until OFF appears.

- ☞ Press the **P** key to confirm.
An alternating display of the current reference temperature and OFF appears on the upper display.
The current set temperature appears on the lower display

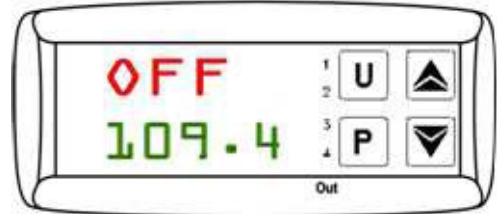

Control OFF setting display



TAKE NOTICE OF:

The controller is now switched off and the reference temperature will continuously change and adjust to the room temperature without having to be further regulated.

Switching on the automatic control:

The control is switched off if the following display appears:

An alternating display of the current reference temperature and OFF appears on the upper display.
The current set temperature appears on the lower display.

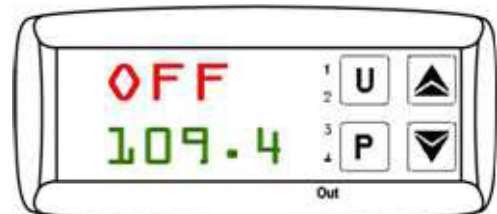

Control OFF setting display

Switch the control back on by

- ☞ Pressing the **P** key for approx. 5 sec, the main menu opens.
OFF appears on the upper display.
LED SET flashes on the lower display.
- ☞ Confirm switching on the controller by pressing the arrow key until the desired operating mode is displayed and confirm this with the **P** key.

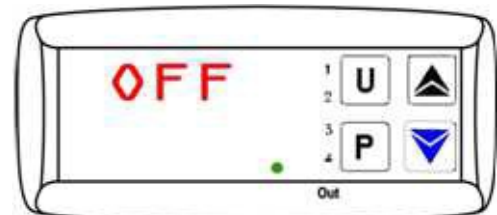

OFF display



PLEASE NOTE:

The control has been reactivated. The calibrator / micro calibration bath is in calibration mode and the set temperature is targeted.

7.3.2 Manual control

Switching on the manual control:

It is possible to switch off the automatic control of the calibrator / micro calibration bath and to achieve the desired temperature via manual control.

- Press the **P** key for approx 5 sec., the main menu opens. The last selected function appears on the upper display.

LED SET flashes on the lower display.

- Press the **▲** or **▼** key until **OPLO** appears.

OPLO appears on the upper display.

LED SET flashes on the lower display.

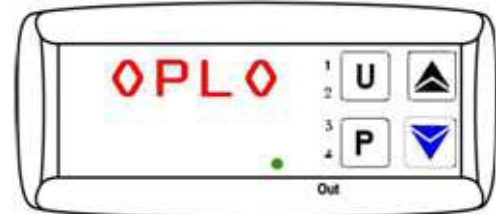

Menu manual control OPLO

- Press the **P** key to confirm. The current reference temperature appears on the upper display. The letter **H** and the currently set output capacity in % appear on the lower display.

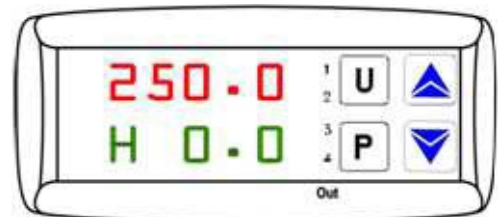

Manual control OPLO setting display

- Press the **▲** key, to increase the output capacity.
- Press the **▼** key, to decrease the output capacity.



PLEASE NOTE:

Press the **▲** and **▼** key to raise and lower the value by 0.1 respectively. If the keys are held pressed for at least one second, the value increases or decreases quickly and after two seconds even more quickly; this means the desired value can be reached rapidly.

Switching off the manual control:

The manual control is switched on if the following display appears:

The current reference temperature appears on the upper display.

The letter **H** and the currently set output capacity in % appear on the lower display.

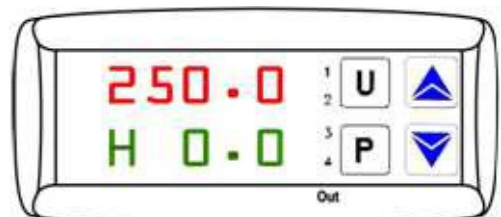

Manual control OPLO setting display

Switch the manual control off again by

- pressing the **P** key for approx. 5 sec., the main menu opens.

OPLO appears on the upper display.

LED SET flashes on the lower display.

- Confirm switching on the automatic controller by pressing the arrow key until the desired operating mode is displayed and confirm this with the **P** key.

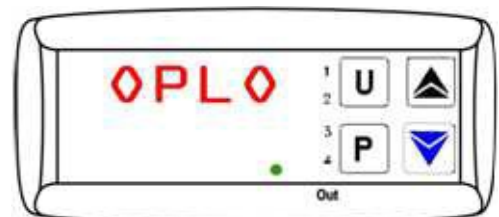

OPLO display

7.3.3 Fixed set temperatures

Setting and saving fixed set temperatures

In order to save set temperatures in the calibrator / micro calibration bath, the respective set point memory has to be opened

- Press the **P** key for approx. 5 sec. when in calibration mode, the main menu opens

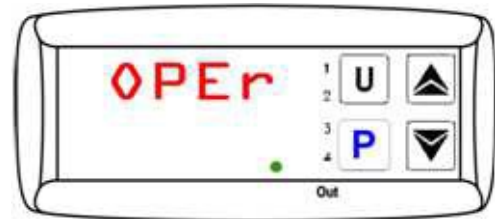

operator menu OPER

OPER appears on the upper display.
LED SET flashes on the lower display.

- Press the **P** key again, the group level opens.

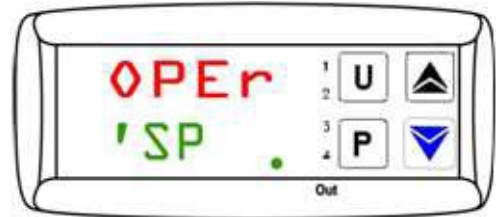

Group SP

OPER appears on the upper display.
SP appears on the lower display and LED SET flashes.

- Press the **P** key again, the parameter level opens.
SP appears on the upper display.
 The set point memory **SP 1** and LED SET flash on the lower display.

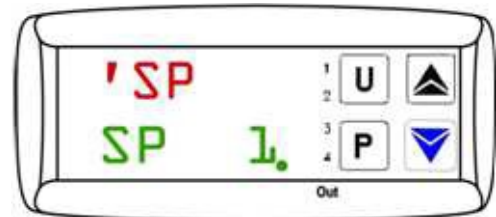

Parameter for the set memory SP1

- Use the **▲** or **▼** key to select one of the four set point memories SP1, SP2, SP3 and SP4.

- Press the **P** key to open the respective set point memory.
 The selected set point memory, e.g. SP 3 flashes on the upper display.
 The corresponding current set temperature appears on the lower display.

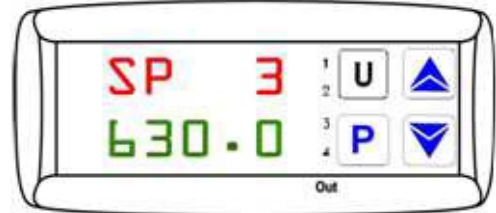

Set point memory SP3 entry

- Press the **▲** key to increase the set temperature.
- Press the **▼** key to decrease the set temperature.



Press the **▲** and **▼** key to raise and lower the value by 0.1 respectively. If the keys are held pressed for at least one second, the value increases or decreases quickly and after two seconds even more quickly; this means the desired value can be reached rapidly.

- Press the **P** key to confirm the set temperature.
 The set point memory closes and the display returns to the parameter level.
- Press and hold the **▲** or **▼** key to return to the calibration mode.

If no key is pressed for approx. 15 seconds, the device automatically returns to a previous level up to the calibration mode.

Retrieving the saved set temperatures (S version):

The saved set temperatures can be retrieved in calibration mode.

- Press the **U** key for approx 2 sec., the current set point memory opens.

The current reference temperature appears on the upper display.

The set point memory **SP...** appears on the lower display for 2 sec. followed by the current set temperature.

- To receive another saved set point SP1, SP2, SP3 or SP4, press the **U** key again.

The selected temperature value is immediately adopted and targeted.

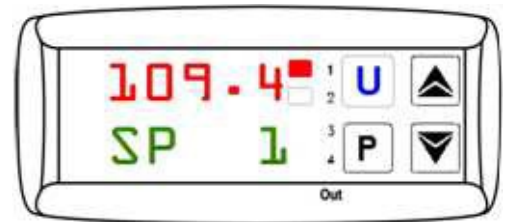

Retrieving the set temperatures display

7.3.4 Setting a gradient control and a temperature profile

It is possible to carry out a gradient control yourself and thus determine the time in which the set temperature is reached. The time can be shorter or longer than the time usually required by the calibrator / micro calibration bath.

When modifying the set temperature or switching on the calibrator / micro calibration bath it is automatically determined which of the gradients (heating gradient "SLoF" or cooling gradient "SLoF") is to be used.

Additionally, you can ensure that the calibrator / micro calibration bath switches to the set temperature in set point memory SP2 as soon as the set temperature in set point memory SP1 has been achieved and after a programmed duration time "dur.t"; this creates a simple temperature profile.

After switching on the calibrator / micro calibration bath the temperature profile is automatically carried out.

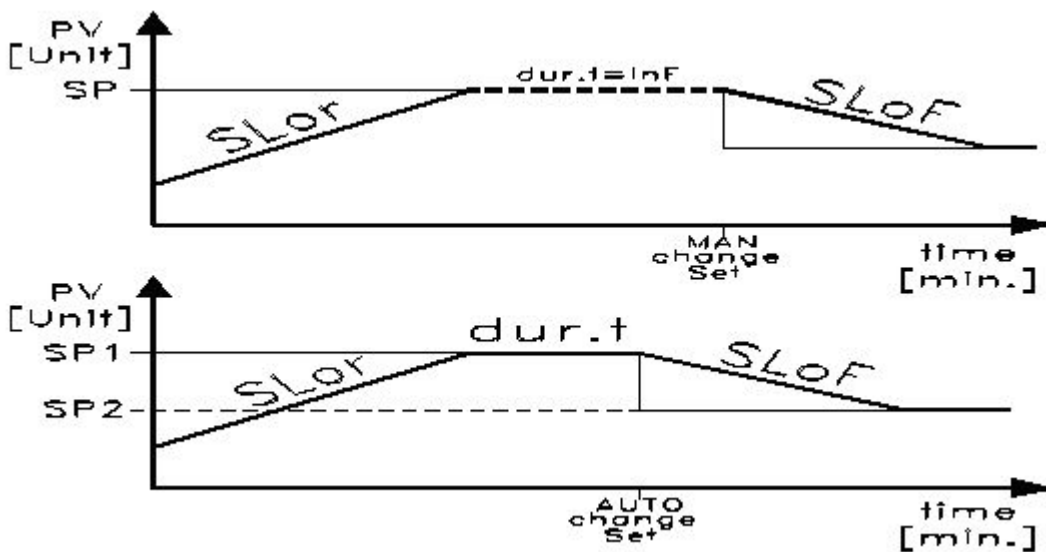

Gradient control and temperature profile

Setting values for „SLor“ and „SLoF“

Calibrator type	Heating gradient ¹⁾		Cooling gradient ²⁾	
	„SLor“		„SLoF“	
Heating/Cooling:				
DryTC 165	< 7 °C (44.6 °F)/min		< 5 °C (41 °F)/min	
LiquidTC 165				
- with silicone oil 10CS	< 3 °C (37.4 °F)/min		< 6 °C (42.8 °F)/min	
- with distilled water	< 5 °C (41 °F)/min		< 4 °C (39.2 °F)/min	
- as dry block	< 3 °C (37.4 °F)/min		< 4 °C (39.2 °F)/min	
- as infrared calibrator	< 3 °C (37.4 °F)/min		< 4 °C (39.2 °F)/min	
Heating:				
DryTC 650	< 35 °C (95 °F)/min	max. ... 300 °C (572 °F) 300 °C (572 °F) ... 100 °C (212 °F)	< 10 °C (50 °F)/min < 5 °C (41 °F) /min	
LiquidTC 255				
- with silicone oil 50CS	< 22 °C (71.6 °F)/min	200 °C (392°F) ... 50 °C (122°F) 50 °C (122°F) ... 30 °C (86°F)	< 4 °C (42.8°F)/min < 0.5 °C (32.9°F)/min	
- with distilled water	< 12 °C (53.6 °F)/min	90 °C (194°F) ... 50 °C (122°F) 50 °C (122°F) ... 30 °C (86°F)	< 2 °C (35.6°F)/min < 0.5 °C (32.9°F)/min	
- as dry block	< 12 °C (53.6 °F)/min	200 °C (392°F) ... 50 °C (122°F) 50 °C (122°F) ... 30 °C (86°F)	< 2 °C (35.6°F)/min < 0.5 °C (32.9°F)/min	
- as infrared calibrator	< 12 °C (53.6 °F)/min	200 °C (392°F) ... 50 °C (122°F) 50 °C (122°F) ... 30 °C (86°F)	< 2 °C (35.6°F)/min < 0.5 °C (32.9°F)/min	

¹⁾ Heating gradient „SLor“:

The heating gradient "SLor" is active if the reference temperature is lower than the set temperature. Each calibrator type has a max. heating capacity, meaning that only settings < than this heating capacity are reasonable and extend the time until the set temperature is achieved.

²⁾ Cooling gradient „SLoF“:

The cooling gradient "SLor" is active if the reference temperature is higher than the set temperature. Only settings below the cooling capacity of the calibrator have an effect on the cooling gradients.

Duration time „dur.t“:

The duration time "dur.t" is active if the set temperature SP1 has been achieved. Subsequently, the calibrator / micro calibration bath automatically switches to set temperature SP2.

ACTIVATE TEMPERATURE PROFILE!



If you have carried out settings for these three settings, the calibrator / micro calibration bath uses the new values only when modifying the set temperature or switching the calibrator off and on again.

A further procedure is to switch off the automatic control prior to modifying parameters and to switch it on again afterwards (□ § 7.3.1).

The heating and cooling gradients and the duration time can be set in the parameter level rEG.

- ↳ Pressing the **P** key for approx. 5 sec., the main menu opens.
The last selected function appears on the upper display.
LED SET flashes on the lower display.

- ↳ Press the **▲** or **▼** key until **OPEr** appears.

- ↳ Press the **P** key again, the group level opens.
OPEr appears on the upper display.
SP appears on the lower display and LED SET flashes.

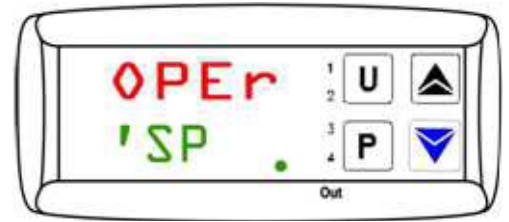

Group SP

- ↳ Use the **▼** key to select the group **'rEG**.

OPEr appears on the upper display.
'rEG. appears on the lower display and LED SET flashes.

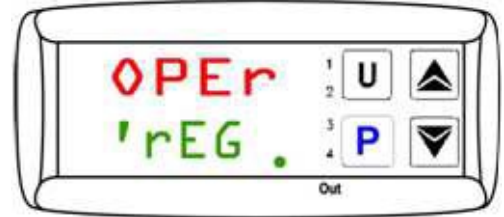

Group rEG

- ↳ Press the **P** key again, the parameter level opens.

'rEG. appears on the upper display.
SLor flashes on the lower display

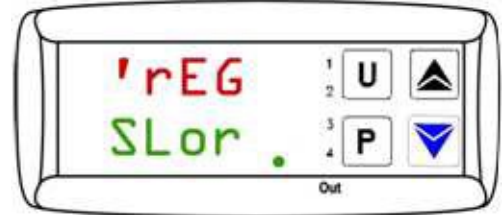

Parameters for heating gradient SLor

7.3.4.1 Setting the heating gradient

The heating gradient "**SLor**" is active if the reference temperature is lower than the set temperature.

The setting range extends from 99.99 °C (211.98 °F)/min up to 0.00 °C (32 °F)/min.



PLEASE NOTE:

The function is deactivated if **SLor = InF** (In no Function) has been set.

You are in the parameter level.

rEG appears on the upper display.
SLor flashes on the lower display.



Parameters for heating gradient SLor

- Press the **P** key.
SLor flashes on the upper display.
 The respective currently set heating gradient appears on the lower display.

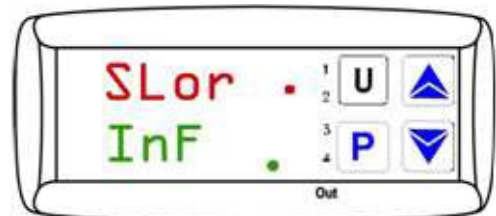

Heating gradient entry

- Press the **▲** key to increase the heating gradient SLor.
 Press the **▼** key to decrease the heating gradient **SLor**



Press the **▲** and **▼** key to raise and lower the value by 0.1 respectively. If the keys are held pressed for at least one second, the value increases or decreases quickly and after two seconds even more quickly; this means the desired value can be reached rapidly.

- Press the **P** key to confirm the set heating gradient **SLor**.
 The display returns to the parameter level and you can set the other parameters.

Automatic return!

If no key is pressed for approx. 15 seconds, the device automatically returns to a previous level up to the calibration mode.



Activate temperature profile!

After carrying out the settings, the calibrator uses the new values only when modifying the set temperature or switching the calibrator/micro calibration bath off and on again.

7.3.4.2 Setting the cooling gradient

The cooling gradient "**SLoF**" is active if the reference temperature is higher than the set temperature.

The setting range extends from 99.99 °C (211.98 °F)/min up to 0.00 °C (32 °F)/min.



PLEASE NOTE:

The function is deactivated if **SLoF = InF** (In no Function) has been set.

You are in the parameter level.

rEG appears on the upper display.
SLoF flashes on the lower display.

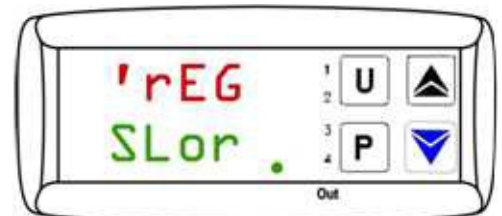

Parameters for heating gradient SLoF

Use the ▲ or ▼ key to select the parameter **SLoF**.

rEG appears on the upper display.
SLoF flashes on the lower display

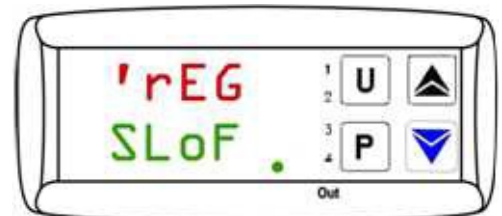

Cooling gradient entry

Press the **P** key.

SLoF flashes on the upper display.
The respective currently set cooling gradient appears on the lower display.

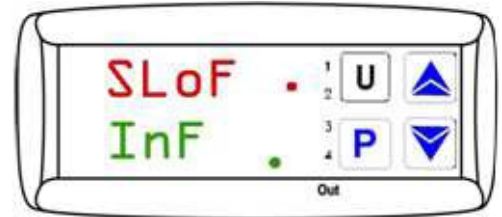

Display of the cooling gradient input

Press the ▲ key to increase the cooling gradient **SLoF**.

Press the ▼ key to decrease the cooling gradient **SLoF**.



Press the ▲ and ▼ key to raise and lower the value by 0.1 respectively. If the keys are held pressed for at least one second, the value increases or decreases quickly and after two seconds even more quickly; this means the desired value can be reached rapidly.

Press the **P** key to confirm the set cooling gradient SLoF.

The display returns to the parameter level and other parameters can be set.

Automatic return!

If no key is pressed for approx. 15 seconds, the device automatically returns to a previous level up to the calibration mode.



Activate temperature profile!

After carrying out the settings, the calibrator / micro calibration bath uses the new values only when modifying the set temperature or switching the calibrator / micro calibration bath off and on again.

7.3.4.3 Setting the duration time

The duration time "**dur.t**" is active if the set temperature SP1 has been achieved. Subsequently, the calibrator / micro calibration bath automatically switches to set temperature SP2.

The setting range extends from 99:59 [hh:min] to 00:00 [hh:min].



PLEASE NOTE:

The function is deactivated if **dur.t = InF** (In no Function) has been set.

You are in the parameter level.

rEG appears on the upper display.
SLor flashes on the lower display.

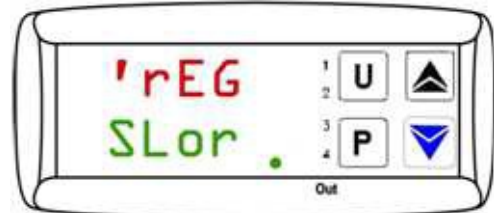

Parameters for heating gradient SLor

Use the ▲ or ▼ key to select the parameter dur.t.

rEG appears on the upper display.
SLoF flashes on the lower display

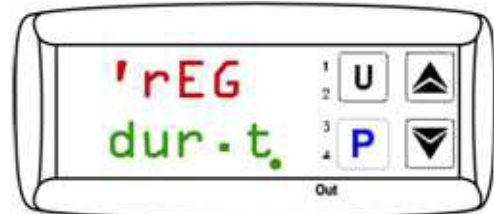

Parameters for the duration time dur.t

↵ Press the **P** key.
dur.t flashes on the upper display.
 The respective currently set duration time appears on the lower display.

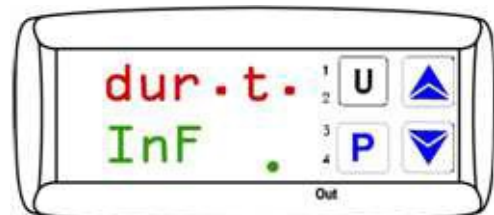

Duration time entry

↵ Press the ▲ key to increase the duration time dur.t.
 ↵ Press the ▼ key to decrease the duration time dur.t.



Press the ▲ and ▼ key to raise and lower the value by 0.1 respectively. If the keys are held pressed for at least one second, the value increases or decreases quickly and after two seconds even more quickly; this means the desired value can be reached rapidly.

↵ Press the **P** key to confirm the set duration time **dur.t**.
 The display returns to the parameter level.

Automatic return!

If no key is pressed for approx. 15 seconds, the device automatically returns to a previous level up to the calibration mode.



Activate temperature profile!

After carrying out the settings, the calibrator / micro calibration bath uses the new values only when modifying the set temperature or switching the calibrator / micro calibration bath off and on again.

8 Cooling Down of the Metal Block / Liquid Bath

CAUTION! Risk of burns:



Prior to transport or contact with the metal block / liquid bath ensure that it has cooled down sufficiently; otherwise there is a risk of severe burns at the metal block / liquid bath and the test specimen.

↳ In order to cool down the metal block / liquid bath quickly, set the set temperature to a low temperature, e.g. room temperature.

The installed fan gently and automatically switches to a higher speed for heating instruments, thus providing more cooling air. The LED OUT 2 indicates the status of the output for the fan control. If the LED OUT 2 lights up, the fan is running at high speed. If the LED OUT 2 does not light up, the fan is running at low speed.

The controller switches the active cooling on for heating / cooling instruments. The LED OUT 2 indicates the status of the output for the active cooling. If the LED OUT 2 lights up, the active cooling is running. If the LED OUT 2 does not light up, the cooling is not active.



PLEASE NOTE:

After switching off or after removing the mains connection, the installed fan can no longer provide cooling air. Nevertheless, sufficient thermal isolation between the metal block / liquid bath and the housing is still guaranteed.

9 Cleaning and Maintenance

↳ Allow the calibrator / micro calibration bath to cool down as described in sect. (□ § 8).

↳ Switch the calibrator / micro calibration bath off and disconnect the mains plug.

9.1 Maintenance

The DryTC / LiquidTC is maintenance-free and cannot be repaired by the user. In case of a defect, the device must be replaced or returned to the manufacturer for repair.



CAUTION! Material damage!

When opening the device, critical parts or components can be damaged.

↳ Never open the device and perform any repair yourself.

9.2 Cleaning

External cleaning:

Clean the DryTC / LiquidTC with a dry or slightly damp lint-free cloth. Do not use sharp objects or aggressive agents for cleaning.

Cleaning the fan grille:

Each calibrator is fitted with a small meshed air grille via which cooling air enters the calibrator.

- ↳ Clean the grille at regular intervals (vacuuming or brushing) depending on the level of air pollution.

Cleaning calibrators with sleeves:

A small amount of brass dust is created when operating calibrators with sleeves, this can cause the metal block and sleeve to jam.

- ↳ To prevent this, remove the sleeves from the heating block at regular intervals and if the calibrator is not going to be operated for a longer period.
- ↳ Flush the heating block bore with compressed air and clean the bore and sleeve with a dry cloth.



CAUTION! Dangers of compress air and brass dust

Please aware about the dangers of using compress air and the danger created by the expelled brass dust.

- ↳ Always necessary to use a suitable breathing mask, gloves, safety glasses and clothing.

Cleaning the micro calibration bath:

Silicone oil:

- ↳ Drain as much of the silicone oil as possible with the aid of the supplied bilge pump.
- ↳ Subsequently remove the sensor cage from the tank and clean the cage, magnetic stirrer and the tank with water and plenty of washing-up liquid. Allow everything to dry completely.

Distilled water:

- ↳ If you are using distilled water, remove the calibration liquid and allow the sensor cage, magnetic stirrer and tank to dry completely.

10 Problems

Problems:

The following table details what problems you can solve yourself and how to solve them.

Problem	Possible Cause	Remedy
----	Interruption of the internal reference sensor or the internal reference sensor is defective.	The controller switches off the power supply to the heating cartridge (servicing required).
uuuu	Measured temperature under the limit value of the internal reference sensor (under range -200 °C (392°F))	
oooo	Measured temperature above the limit value of the internal reference sensor (over range +850 °C (1562°F))	
ErEP	Possible fault in the EEPROM memory of the controller	Press the P key
Fan not running	The fan is defective or blocked	The temperature switch is possibly triggered, switching off the power supply to the heating cartridge (servicing required)
End temperature is not achieved	Solid state relay is defective or the heating / cooling element has short circuited or aged	Servicing required
No display	Controller defective	Servicing required
No function	Network connection not established correctly or fuse defective	Check the network connection and fuse

If servicing is required, shut down the calibrator / micro calibration bath and return it to the manufacturer (□ § 13 "Decommissioning and Disposal").

11 Warranty and Repairs

The calibrator/micro calibration bath is under guarantee for 12 months as from the date of delivery for construction errors or material defects. The guarantee is limited to repairs or replacing the calibrator / micro calibration bath.

Warranty shall not apply if the calibrator / micro calibration bath is opened and unauthorized repair work is carried out or if the calibrator / micro calibration bath is not used for its intended purpose or installed incorrectly.

If the calibrator / micro calibration bath malfunctions during or after the warranty period, always contact the GE "Sales Dept." before sending the calibrator / micro calibration bath for repairs.

The defective calibrator / micro calibration bath incl. details of the occurred fault can be sent freight paid to GE, unless other agreements have been made.

12 Recalibrating

The calibrator / micro calibration bath is adjusted and tested with measuring equipment in accordance with recognized national standards prior to delivery.

The calibrator / micro calibration bath should, depending on the application situation, be inspected at appropriate intervals on the basis of DIN ISO 10 012. We recommend you to return the calibrator / micro calibration bath to GE at intervals of max. 12 months or approx. 500 operating hours for recalibration and readjustment.

Recalibration is based on the directive DKD R5-4 of the German Calibration Service. The measures described here are applied and considered during recalibration.

13 Decommissioning and Disposal

Decommissioning:

- ☞ Allow the instrument to cool down (□ § 8 "Cooling Down of the Metal Block / Liquid Bath").
- ☞ Switch off the calibrator / micro calibration bath and disconnect the mains plug.
- ☞ If necessary, remove any existing calibration liquid from the micro calibration bath (□ § 9.2 "Cleaning").

Disposal:



IMPORTANT NOTICE!

Dispose of the silicone oil in accordance with the specifications on the safety data sheet.



NO HOUSEHOLD WASTE!

The calibrators of the series DryTC / LiquidTC consist of various different materials. It must not be disposed of with household waste.

- ☞ Take the DryTC / LiquidTC to your local recycling plant
- or
- ☞ send the DryTC / LiquidTC back to your supplier or to GE.

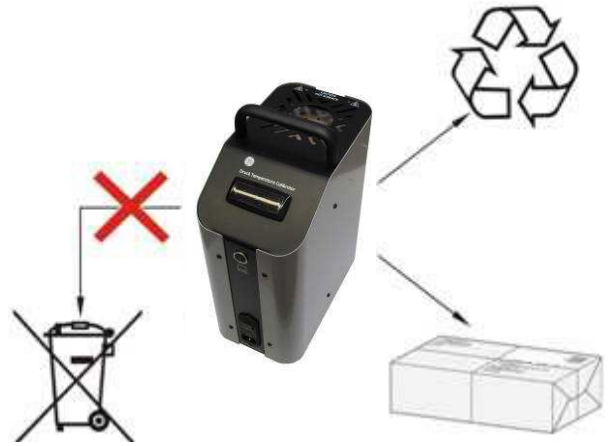

14 Technical data

The technical data of customised versions may differ from the data in these instructions. Please observe the information specified on the type plate.

14.1 Shared characteristics

Series	DryTC	LiquidTC
Characteristics		
Calibrator		
Influence of the operating temperature (0...50 °C) to the accuracy	+/- 0.02 °C/°C (32.04 °F/°F)	
Resolution reference temperature setting range	0.1 °C (32.18 °F)	
Detection speed	130 ms	
Display		
Resolution	0.01 °C (32.02 °F) (-9.99 ... 99.99), else 0.1 °C (32.02 °F)	
Display unit	°C or °F (optional)	
Two-line display: - Reference temperature - Target temperature	4-digit, 7-segment LED, 7mm high red = upper display, green = lower display	
Display for sensor break	- - - -	
Sensor break behaviour	the control is switched off	
Excess temperature behaviour	temperature fuses interrupt the power supply if there is excess temperature inside the housing	
Electrical characteristics		
Block temperature control	via PID-controller	
Controller outputs: - Heater control - Cooler control - Fan control	voltage output for control of the solid state relay (8 mA/ 8 VDC) voltage output for control of the solid state relay (8 mA/ 8 VDC) relay SPDT (8 A-AC1, 3 A-AC3 / 250 VAC) 100,000 switching cycle	
Degree of protection	IP 20	
Process variables		
Operating temperature	0...50 °C (32...122 °F)	
Moisture in the operating area	30...95 %rF (not condensing)	
Transport and storage temperature	-10...60 °C (14...140 °F)	

14.2 Characteristics DryTC series

Characteristics \ Series	DryTC 165	DryTC 650
Calibrator		
Display range:	-50...165 °C (-58...329 °F)	0...650 °C (32...1202 °F)
Setting range:		
- Dry block	Ambient <20 °C: -35 °C...165 °C (Ambient <68 °F: -31 °F...329 °F)	Ambient +15 °C to 650 °C (Ambient +59 °F to 1202 °F)
	Ambient <30 °C: -30 °C...165 °C (Ambient <86 °F: -22 °F...329 °F)	
	Ambient <40 °C: -25 °C...165 °C (Ambient <104 °F: -13 °F...329 °F)	
	Ambient <50 °C: -15 °C...165 °C (Ambient <122 °F: 5 °F...329 °F)	
Tolerance:		
- Dry block	0.2 °C (32.36 °F)	0.4 °C (32.72 °F)
Control stability:		
- Dry block	0.05 °C (32.09 °F)	0.05 °C (32.09 °F)
Electrical characteristics		
Power supply:		
- 110/230 VAC	50/60 Hz	50/60 Hz
Power consumption	~400 VA	~1000 VA
Fuse:		
- 110/230 VAC	T 6.3 A H 250 V	T 10 A H 250 V
Serial interface:		
- Serial interface (optional)	USB	USB
- Communication protocol	MODBUS RTU (JBUS)	MODBUS RTU (JBUS)
Process variables		
Test specimen holder:		
- Bore	28 mm	28 mm
- Depth	150 mm	150 mm
Housing dimensions:		
- Width	~210 mm	~147 mm
- Height	~380+50 mm	~330+68 mm
- Depth	~300 mm	~269 mm
Weight	~11.4 kg	~7.5 kg
Sleeves for smaller (in 0.5 mm steps)	1.5...25 mm	1.5...25 mm

14.3 Characteristics series LiquidTC

Characteristics	Series	LiquidTC 165	LiquidTC 255
Calibrator			
Display range		-50...165 °C (-58...329 °F)	0...255 °C (32...491 °F)
Setting range:			
- Dry block		Ambient <20 °C: -35 °C...165 °C (Ambient <68 °F: -31 °F...329 °F)	Ambient +15 °C to 255 °C (Ambient +59 °F to 491 °F)
		Ambient <30 °C: -30 °C...165 °C (Ambient <86 °F: -22 °F...329 °F)	
		Ambient <40 °C: -25 °C...165 °C (Ambient <104 °F: -13 °F...329 °F)	
		Ambient <50 °C: -15 °C...165 °C (Ambient <122 °F: 5 °F...329 °F)	
- Infrared black body		Ambient <20 °C: -35 °C...165 °C (Ambient <68 °F: -31 °F...329 °F)	Ambient +15 °C to 255 °C (Ambient +59 °F to 491 °F)
		Ambient <30 °C: -30 °C...165 °C (Ambient <86 °F: -22 °F...329 °F)	
		Ambient <40 °C: -25 °C...165 °C (Ambient <104 °F: -13 °F...329 °F)	
		Ambient <50 °C: -15 °C...165 °C (Ambient <122 °F: 5 °F...329 °F)	
- Micro calibration bath (silicone oil)		Ambient <20 °C: -35 °C...165 °C (Ambient <68 °F: -31 °F...329 °F)	Ambient +15 °C to 255 °C (Ambient +59 °F to 491 °F)
		Ambient <30 °C: -30 °C...165 °C (Ambient <86 °F: -22 °F...329 °F)	
		Ambient <40 °C: -25 °C...165 °C (Ambient <104 °F: -13 °F...329 °F)	
		Ambient <50 °C: -15 °C...165 °C (Ambient <122 °F: 5 °F...329 °F)	
- Micro calibration bath (water)		0...100 °C (32...212 °F)	Ambient +15 ° to 100 °C (Ambient +59 ° to 212 °F)
Tolerance:			
- Dry block		0.3 °C (32.54 °F)	0.4 °C (32.72 °F)
- Infrared black body		0.5 °C (32.9 °F)	0.5 °C (32.9 °F)
- Micro calibration bath		0.1 °C (32.18 °F)	0.2 °C (32.36 °F)
Emission degree			
- Infrared black body		0.9994	0.9994
Control stability:			
- Dry block		0.05 °C (32.09 °F)	0.05 °C (32.09 °F)
- Infrared black body		0.05 °C (32.09 °F)	0.05 °C (32.09 °F)
- Micro calibration bath		0.05 °C (32.09 °F)	0.05 °C (32.09 °F)

Characteristics \ Series	LiquidTC 165	LiquidTC 255
Electrical Characteristics		
Power supply: - 110/230 VAC	50/60 Hz	50/60 Hz
Power consumption	~400 VA	~1000 VA
Fuse: - 110/230 VAC	T 6.3 A H 250 V	T 10 A H 250 V
Serial interface: - Serial interface (optional) - Communication protocol	USB MODBUS RTU (JBUS)	USB MODBUS RTU (JBUS)
Process variables		
Test specimen holder: - Bore / Depth	60 mm / 163 mm	60 mm / 163 mm
Housing dimensions: - Width - Height - Depth	~210 mm ~380+50 mm ~300 mm	~147 mm ~330+68 mm ~269 mm
Weight	~13.0 kg	~7.5 kg
Sensor basket working depth	150 mm	150 mm